



SOLOLEGNO





Dal cuore del legno, **Sololegno**

FROM THE HEART OF THE WOOD: SOLOLEGNO

“La parola del legno non è uniforme, è una polifonia di rumori ardenti che hanno come diapason le foglie mosse dal vento”. In questi versi della poetessa Alda Merini è contenuta l’essenza di un elemento che in natura comunica tutto il suo calore e la sua gentilezza. Materiale vivo e mutevole, il legno è capace di prendere le forme più svariate, accostandosi alle necessità dell’uomo con fierezza, pronto a diventare un oggetto unico e inimitabile. Le porte Sololegno sono pronte a dimostrarvi che nella vita nulla è impossibile se si hanno salde radici, tronchi robusti e rami che sognano di accarezzare il cielo.

“THE WORD OF WOOD IS NOT UNIFORM, IT IS A POLYPHONY OF BURNING NOISES THAT HAVE AS TUNING FORK THE LEAVES MOVED BY THE WIND.”
IN THESE VERSES BY THE POET ALDA MERINI IS CONTAINED THE ESSENCE OF AN ELEMENT THAT IN NATURE COMMUNICATES ALL ITS WARM AND KINDNESS. A LIVING AND CHANGEABLE MATERIAL, WOOD IS ABLE TO TAKE ON THE MOST VARIED FORMS, READY TO BECOME A UNIQUE AND INIMITABLE OBJECT. SOLOLEGNO DOORS ARE READY TO SHOW YOU THAT IN LIFE NOTHING IS IMPOSSIBLE IF YOU HAVE FIRM ROOTS, STRONG TRUNKS AND BRANCHES THAT DREAM OF CARESSING THE SKY.

Dal profumo del legno undici collezioni da vivere

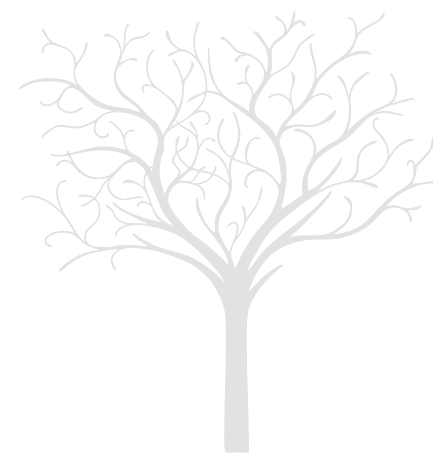

ELEVEN COLLECTIONS OF DOORS ARE
BORN FROM THE SCENT OF WOOD

*Rispettose del passato, ma proiettate al futuro.
Sono le porte delle undici collezioni che compongono
la linea Sololegno; aperture che dal valore del legno e
dai suoi profumi prendono ispirazione per guardare agli
ambienti contemporanei con design nuovi e accattivanti.
In queste pagine tutti i modelli sono presentati in modo
essenziale ed elegante per esaltare prodotti di qualità
superiore e curati nei minimi particolari.
Accostamenti in ambientazioni naturali donano
un'identità ben precisa a modelli ricchi di finiture, colori e
soluzioni che ben si adattano in ogni abitazione.*

RESPECTFUL OF THE PAST, BUT PROJECTED INTO THE FUTURE. THESE ARE THE
DOORS OF THE ELEVEN COLLECTIONS THAT MAKE UP THE SOLOLEGNO LINE; OPE-
NINGS THAT TAKE INSPIRATION FROM THE VALUE OF WOOD AND ITS SCENTS TO
LOOK AT CONTEMPORARY ENVIRONMENTS WITH NEW AND ATTRACTIVE DESIGNS.
IN THESE PAGES ALL THE MODELS ARE PRESENTED IN AN ESSENTIAL AND ELEGANT
WAY TO EXALT PRODUCTS OF SUPERIOR QUALITY AND ATTENTION TO DETAIL.
COMBINATIONS IN NATURAL SETTINGS GIVE A VERY PRECISE IDENTITY TO MODELS
RICH IN FINISHES, COLORS AND SOLUTIONS THAT FIT WELL IN EVERY HOME.

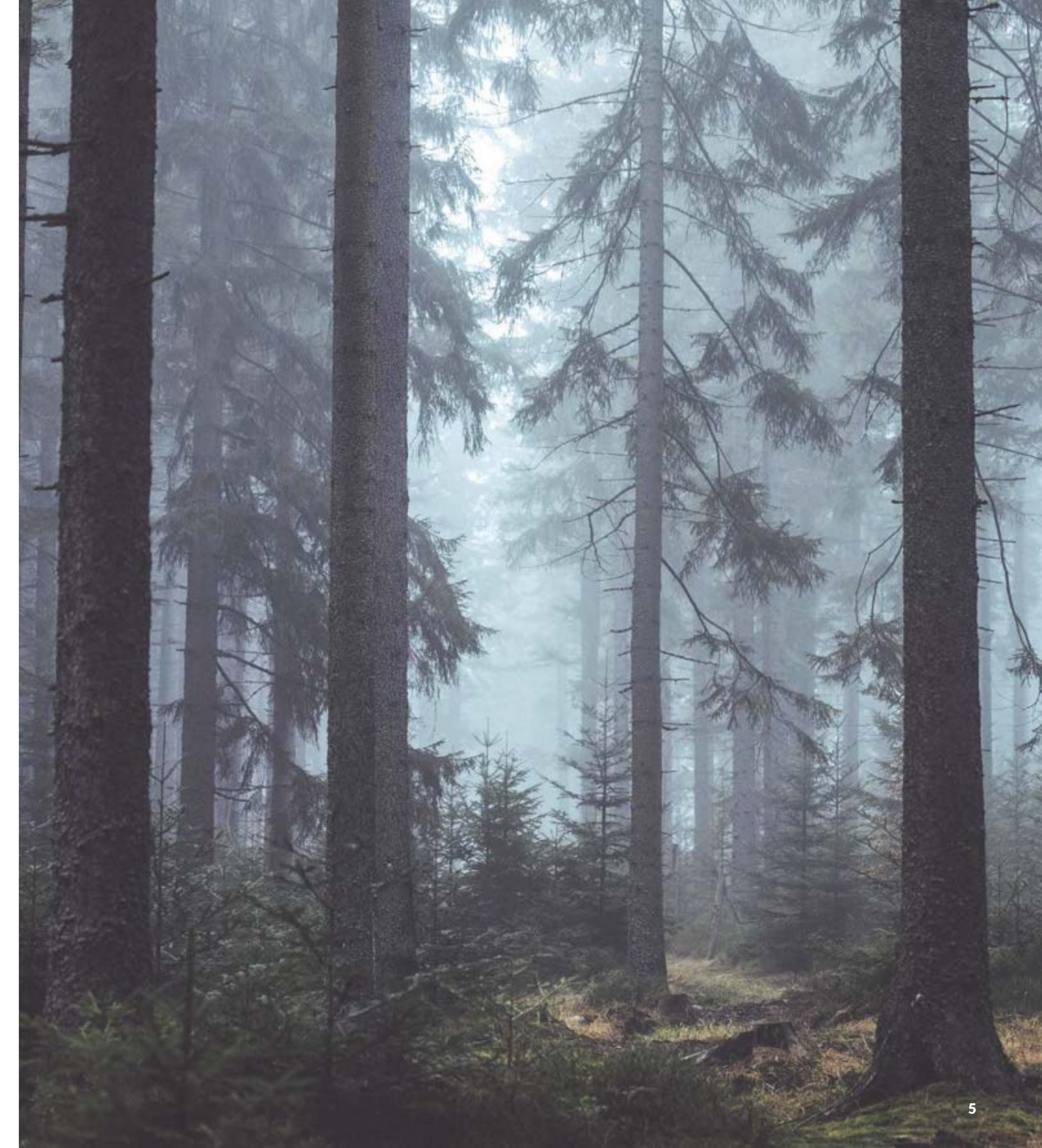





Soluzioni green per una **produzione sostenibile**

GREEN SOLUTIONS FOR SUSTAINABLE PRODUCTION

L'azienda AIP è da tempo costantemente impegnata nella ricerca di soluzioni e applicazioni utili a realizzare porte dal ridotto impatto ambientale. A partire dalla fornitura di energia elettrica utilizzata per la produzione, prodotta da un impianto fotovoltaico, e dagli imballaggi realizzati interamente in carta e in cartone 100% riciclabili. La filosofia "green" di AIP si completa con l'impiego di vernici provenienti da fornitori attenti all'ambiente e desiderosi di lasciare ai nostri figli un pianeta più sostenibile.

THE COMPANY AIP HAS LONG BEEN CONSTANTLY ENGAGED IN THE SEARCH FOR SOLUTIONS AND APPLICATIONS USEFUL TO REALIZE DOORS WITH REDUCED ENVIRONMENTAL IMPACT. STARTING FROM THE SUPPLY OF ELECTRICITY USED FOR PRODUCTION, PRODUCED BY A PHOTOVOLTAIC SYSTEM, AND PACKAGING MADE ENTIRELY OF PAPER AND CARDBOARD 100% RECYCLABLE, THE "GREEN" PHILOSOPHY OF AIP IS COMPLETED BY THE USE OF PAINTS FROM SUPPLIERS WHO ARE ENVIRONMENTALLY FRIENDLY AND EAGER TO LEAVE OUR CHILDREN A MORE SUSTAINABLE PLANET.

Porte 100% Made in Italy

DOORS 100% MADE IN ITALY

Belle, affidabili e durature come solo i prodotti Made In Italy sanno essere. Ogni fase di produzione delle porte Sololegno “parla” italiano: dall’idea alla base di ogni modello alla sua realizzazione, che avviene esclusivamente utilizzando componenti realizzate nel nostro Paese e assemblate nello stabilimento di Barge, in provincia di Cuneo. Per finire con i rigorosi controlli della qualità, passaggio fondamentale per non deludere le attese di chi decide di acquistare non soltanto una porta, ma un pezzo dal design riconoscibile e unico. 100% Made in Italy da gustare in tutta tranquillità.

BEAUTIFUL, RELIABLE AND LONG-LASTING AS ONLY MADE IN ITALY PRODUCTS CAN BE. EVERY PRODUCTION PHASE OF SOLOLEGNO DOORS “SPEAKS” ITALIAN: FROM THE IDEA AT THE BASE OF EACH MODEL TO ITS REALIZATION, WHICH TAKES PLACE EXCLUSIVELY USING COMPONENTS MADE IN OUR COUNTRY AND ASSEMBLED IN THE PLANT OF BARGE, IN THE PROVINCE OF CUNEO. FINALLY, THE RIGOROUS QUALITY CONTROLS, A FUNDAMENTAL STEP TO AVOID DISAPPOINTING THE EXPECTATIONS OF THOSE WHO DECIDE TO BUY NOT ONLY A DOOR, BUT A PIECE WITH A RECOGNIZABLE AND UNIQUE DESIGN. 100% MADE IN ITALY TO ENJOY IN TRANQUILITY.



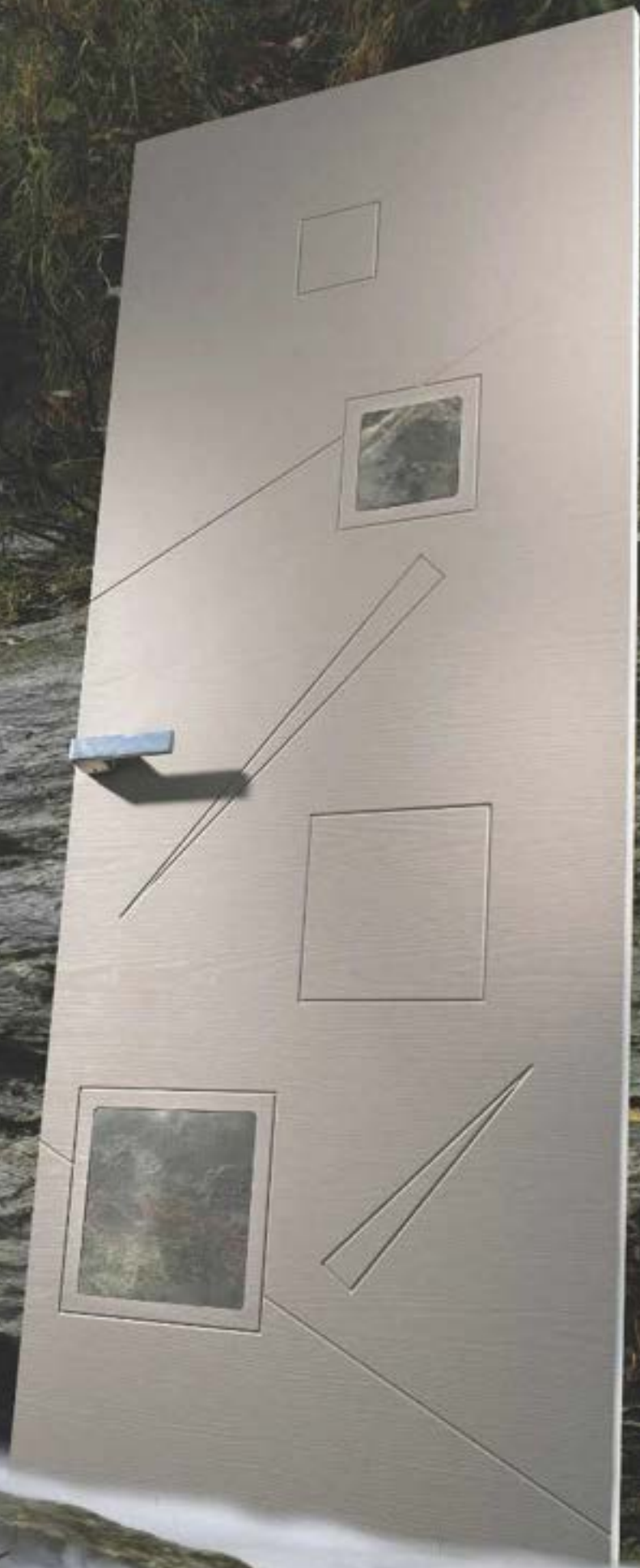

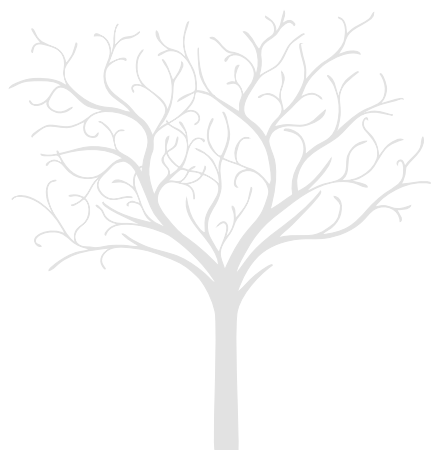

Il colore che **protegge** **l'ambiente**

THE COLOUR THAT RESPECTS THE ENVIRONMENT

Le unicità del legno si esaltano dall'incontro con la maestria e l'esperienza ultra decennale dell'azienda AIP che, coerente con la sua filosofia green, utilizza solo colori naturali e tinte all'acqua capaci di esaltare le venature della materia prima senza arrecare danno all'ambiente.

Grazie ad additivi e ioni d'argento contenuti nelle vernici si combatte con efficacia la proliferazione di batteri, schermando microbiologicamente tutta la porta.

Un'ulteriore importante tappa del percorso che l'azienda in questi anni ha intrapreso per dare il suo contributo concreto alla cura del pianeta e preservarlo per le prossime generazioni.

THE UNIQUENESS OF WOOD IS ENHANCED BY THE ENCOUNTER WITH THE SKILL AND EXPERIENCE OF THIRTY YEARS OF THE COMPANY AIP THAT, CONSISTENT WITH ITS GREEN PHILOSOPHY, USES ONLY NATURAL COLORS AND WATER-BASED COLORS THAT ENHANCE THE GRAIN OF THE RAW MATERIAL WITHOUT CAUSING DAMAGE TO THE ENVIRONMENT. THANKS TO ADDITIVES AND SILVER IONS CONTAINED IN THE PAINTS, THE PROLIFERATION OF BACTERIA IS EFFECTIVELY COMBATED, MICROBIOLOGICALLY SHIELDING THE ENTIRE DOOR. THIS IS ANOTHER IMPORTANT STEP IN THE COMPANY'S JOURNEY OVER THE YEARS TO MAKE A CONCRETE CONTRIBUTION TO THE CARE OF THE PLANET AND PRESERVE IT FOR FUTURE GENERATIONS.





LOCATION: ROERO - BALDISSERO D'ALBA (CN)



Prestige
16



Reset
32



Essenza
54



Concerto
66



Ideale
82



Sintesi
104



Living
118



Stilidea
132



Lineaidea
150



Fiabidea
168



Imagine
188



Soluzioni tecniche

- Finiture di stile* **202**
- Sistemi di apertura* **214**
- Maniglie* **234**
- Vetri* **240**

Il nostro mondo **dietro** **una porta**

OUR WORLD
BEHIND A DOOR

Nulla è più prezioso dell'ambiente in cui viviamo: affetti, ricordi, sentimenti si fondono e prendono luce e profumi nei nostri ricordi da ciò che li circonda. Le porte delle collezioni Sololegno AIP custodiscono queste tue emozioni, ma sono anche lo specchio del territorio da cui arrivano: la provincia di Cuneo con le sue montagne, le sue città, le sue cantine, i suoi boschi... un ambiente da conservare e valorizzare, proprio come casa tua!

NOTHING IS MORE PRECIOUS THAN THE ENVIRONMENT IN WHICH WE LIVE: AFFECTIONS, MEMORIES, FEELINGS MERGE AND TAKE LIGHT AND SCENTS IN OUR MEMORIES FROM WHAT SURROUNDS THEM. THE DOORS OF THE SOLOLEGNO AIP COLLECTIONS PRESERVE THESE EMOTIONS, BUT THEY ARE ALSO THE MIRROR OF THE TERRITORY FROM WHICH THEY COME: THE PROVINCE OF CUNEO WITH ITS MOUNTAINS, ITS CITIES, ITS WINERIES, ITS FORESTS... AN ENVIRONMENT TO BE PRESERVED AND ENHANCED, JUST LIKE YOUR HOME!

The logo for SOLOLEGNO, featuring a stylized leaf icon to the left of the brand name in a serif font.

SOLOLEGNO



LOCATION: CANTINA CASCINA ADELAIDE - BAROLO (CN)



P R E S T I G E

Incroci divergenti

DIVERGENT CROSSINGS

Prestige

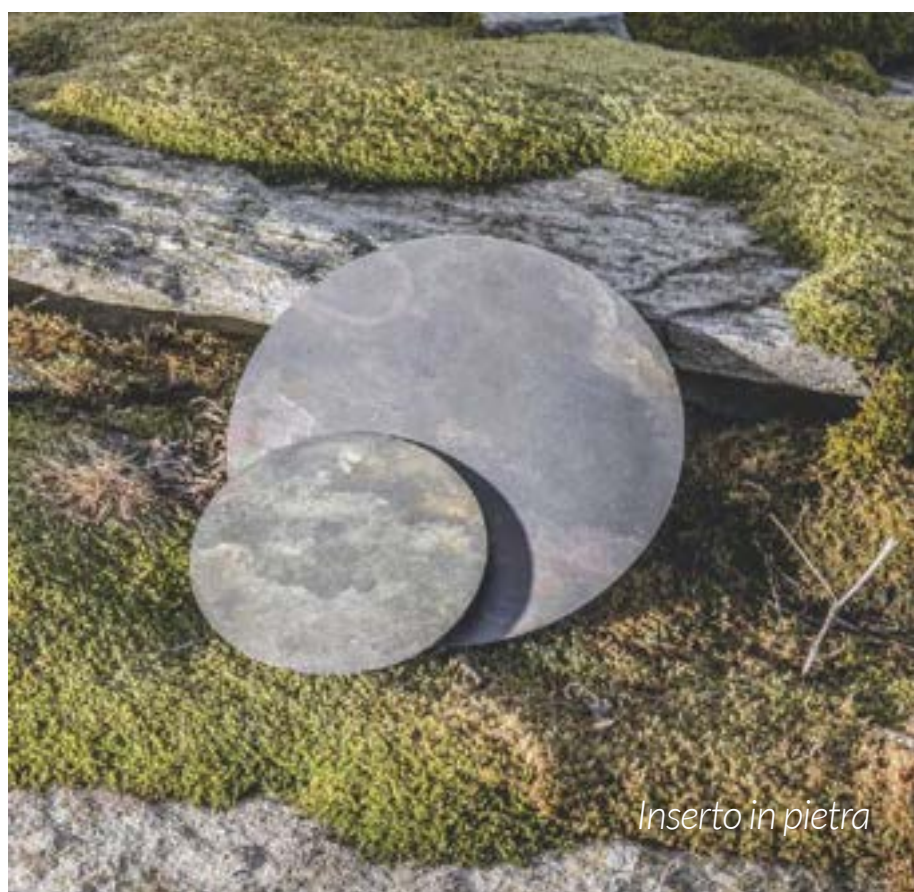

Elementi di prestigio

PRESTIGE ELEMENTS

Legno su legno. Pietra su legno. Inserto lucido su legno. La collezione Prestige è il regno della diversità. Con un tocco di... prestigio elementi differenti si uniscono per dare origine ad ante innovative su base frassino, rovere, rovere natural o liscia, laccata opaco o seta. Modelli disponibili con differenti inserti in pietra naturale, legno (Rovere Natural effetto naturale) o inserti lucidi fusi quasi per incanto. Le imperfezioni della pietra, le irregolarità del legno e la lucidità degli inserti conferiscono alle tue porte un effetto unico. A tratti magico.

WOOD ON WOOD. STONE ON WOOD. GLOSSY METHACRYLATE ON WOOD. THE PRESTIGE COLLECTION IS THE REALM OF DIVERSITY. WITH A TOUCH OF... PRESTIGE, DIFFERENT ELEMENTS COME TOGETHER TO CREATE INNOVATIVE DOORS BASED ON ASH, OAK, NATURAL OAK, MATT LACQUER OR SILK. MODELS AVAILABLE WITH DIFFERENT INSERTS IN NATURAL STONE, WOOD (NATURAL OAK EFFECT) OR POLISHED METHACRYLATE, CAST ALMOST BY MAGIC. THE IMPERFECTIONS OF THE STONE, THE IRREGULARITIES OF THE WOOD AND THE BRIGHTNESS OF THE METHACRYLATE GIVE YOUR DOORS A SINGLE EFFECT. SOMETIMES MAGIC.



PG13

FINITURA · FINISH
Rovere Tinto Bianco Perlato

TELAIO · FRAME
RS

MANIGLIA · HANDLE
Flux

H PORTA · H DOOR
210 cm

INSERTO · INSERT
Bianco

 SOLOLEGNO

P R E S T I G E



LOCATION: PIAN MUNÈ - MONVISO (CN)

PG15

FINITURA · FINISH
Rovere Natural Patinato Grigio Evo

TELAIO · FRAME
TN

MANIGLIA · HANDLE
Sochi

H PORTA · H DOOR
210 cm

INSERTO · INSERT
Pietra



LOCATION: ROERO
BALDISSERO D'ALBA (CN)



PG14

FINITURA - FINISH *Rovere Tinto Caffè*
TELAIO - FRAME *TN*
MANIGLIA - HANDLE *Helsinki*
INSERTO - INSERT *Nero Lucido*



PG10

FINITURA - FINISH
Frassino Laccato Bianco Poro

TELAIO - FRAME
*Scorrevole esterno muro
senza telaio mod. Lineare*

MANIGLIA - HANDLE
KM-MT

H PORTA - H DOOR
210 cm

INSERTO - INSERT
Bianco Lucido

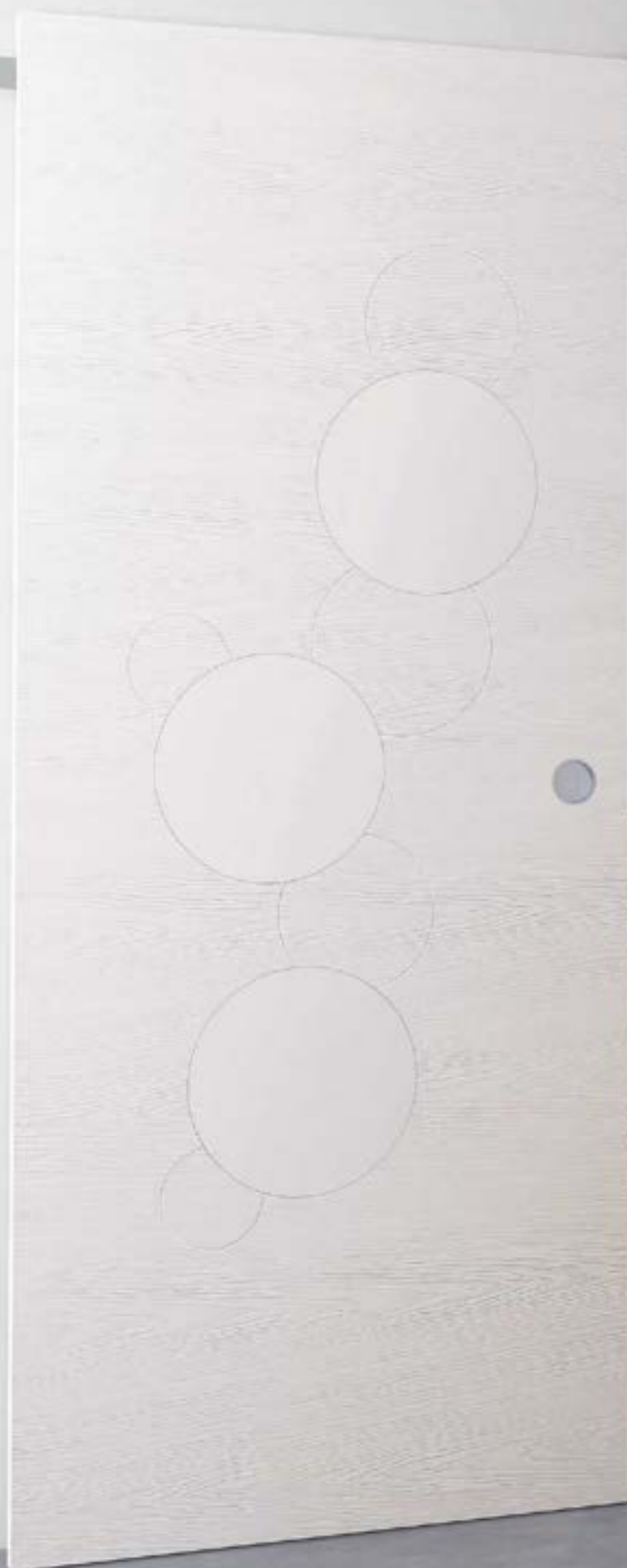



PG11

FINITURA · FINISH
Rovere Tinto Quercia Dark

TELAIO · FRAME
TN

MANIGLIA · HANDLE
Helsinki

INSERTO · INSERT
Pietra



PG12

FINITURA · FINISH
Frassino Patinato Grigio Evo

TELAIO · FRAME
TN

MANIGLIA · HANDLE
Helsinki

INSERTO · INSERT
Pietra





PG1

FINITURA · FINISH
Frassino Tinto Caffè

TELAIO · FRAME
RS

MANIGLIA · HANDLE
Calais

H PORTA · H DOOR
270 cm

INSERTO · INSERT
Nero Lucido



PG3

FINITURA · FINISH
Frassino Patinato Nocciola

TELAIO · FRAME
RS

MANIGLIA · HANDLE
Bordeaux

H PORTA · H DOOR
270 cm

INSERTO · INSERT
Beige Lucido

PG2

FINITURA · FINISH
Rovere Patinato Bianco Neve

TELAIO · FRAME
TN

MANIGLIA · HANDLE
Helsinki

INSERTO · INSERT
Rovere Natural tinto effetto naturale



PG4

FINITURA · FINISH
Frassino Tinto Mascara

TELAIO · FRAME
TN

MANIGLIA · HANDLE
Helsinki

INSERTO · INSERT
Tortora Lucido



P R E S T I G E

 SOLOLEGNO

LOCATION: CANTINA CASCINA ADELAIDE - BAROLO (CN)



Rovere **tinto** spazzolato

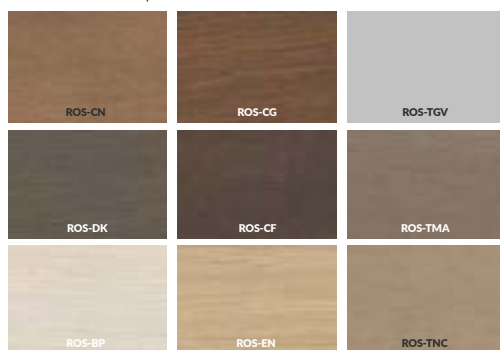

Rovere Natural **tinto** spazz.



Rovere **laccato** spazzolato



Rovere Natural **patinato** spazz.



Frassino **tinto** spazzolato

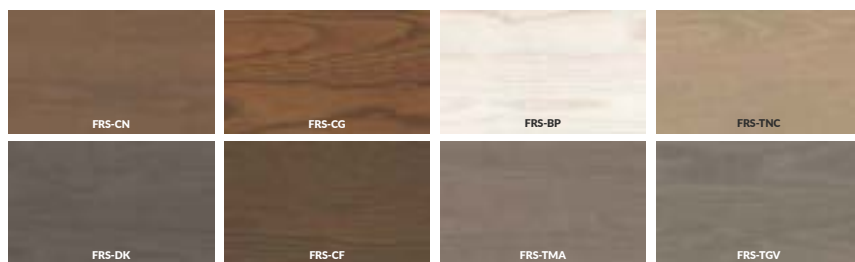

Frassino **laccato** spazzolato

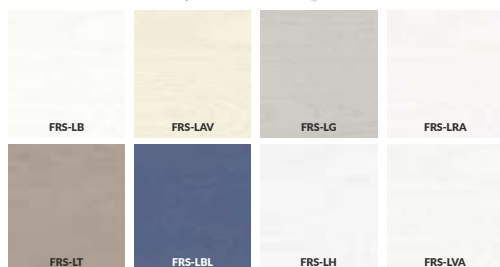

Frassino **patinato** spazz.



Laccato **opaco**



Laccato **effetto seta**

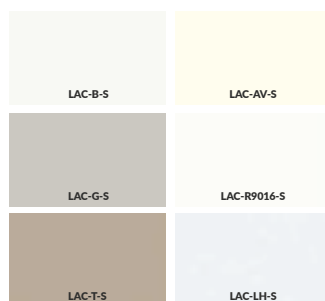

Inserti in **legno**



Inserti in **pietra**



Inserti **lucidi**

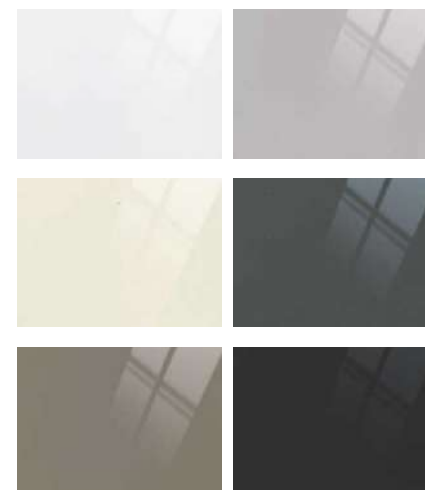

Per verificare le disponibilità degli abbinamenti finitura/inserto consulta pagina 211

PG1



PG2



PG3



PG4



PG10



PG11



PG12



PG13



PG14



PG15



Porta cieca piana tamburata, disponibile nelle versioni a battente, scorrevole interno o esterno muro, pieghevole simmetrica (DUO) o pieghevole asimmetrica 1/3-2/3 (PIEGO). Il telaio perimetrale esterno è in legno massello di abete di circa mm 37x32, essiccato, epurato da nodi e canastro, giuntato a pettine. Il riempitivo in struttura alveolare trattata antitarlo e antimuffa ed il rivestimento in pannelli di fibra di legno a media densità dello spessore di 6 mm.

L'anta può essere rivestita in tranciato pregiato di Frassino orizzontale a fiamme contrapposte, Rovere Natural orizzontale, da 0,5 mm. In base al modello, si possono scegliere vari inserti, in legno effetto naturale (per le versioni laccate), in pietra o lucidi tono su tono.

Le tinte, i patinati o le laccature a poro aperto sono finiture all'acqua

Ferramenta: tre cerniere a scomparsa regolabili su 3 assi o le classiche anuba, serratura patent piccola (solo scrocco) frontale 18 mm ingresso 50 mm disponibili nelle finiture cromato opaco, cromato lucido e ottone lucido, o serratura magnetica nelle finiture cromo satinato, cromo lucido o bianca. Spessore totale anta 44 mm.

VENEERED FLAT BLIND DOOR, AVAILABLE IN THE FOLLOWING VERSIONS: HINGED DOOR, INTERNAL SLIDING DOOR OR EXTERNAL WALL SLIDING DOOR, SYMMETRICAL FOLDING DOOR (DUO) OR ASYMMETRICAL FOLDING DOOR 1/3-2/3 (FOLD).

INTERNAL FRAMEWORK IS MADE OF SOLID FIR WOOD OF ABOUT 37X32 MM, DRIED, PURIFIED FROM KNOTS AND CANES, FINGER-JOINED. THE HONEYCOMB STRUCTURE FILLER IS TREATED AGAINST MOTH AND MILDEW AND THE COVERING IS MADE OF 6 MM THICK MEDIUM-DENSITY WOOD FIBRE PANELS. THE DOOR CAN BE COVERED WITH HIGH-QUALITY ASH VENEER WITH OPPOSING FLAMES, HORIZONTAL NATURAL OAK, 0.5 MM THICK. DEPENDING ON THE MODEL, YOU CAN CHOOSE FROM VARIOUS INSERTS, IN NATURAL EFFECT WOOD (FOR THE LACQUERED VERSIONS), IN STONE OR IN SHINY METHACRYLATE. THE OPEN-PORE COLOURS, PATINATES OR LACQUERS ARE WATER-BASED.

HARDWARE: THREE NOT VISIBLE HINGES ADJUSTABLE ON 3 AXES OR THE CLASSIC ANUBA, SMALL PATENT LOCK (ONLY LATCH) FRONTAL 18 MM AVAILABLE IN MATT CHROME, POLISHED CHROME AND POLISHED BRASS FINISHES, OR MAGNETIC LOCK IN SATIN CHROME, POLISHED CHROME OR WHITE FINISHES. SWING THICKNESS 44 MM.

 SOLOLEGNO



LOCATION: CANTINA CASCINA ADELAIDE - BAROLO (CN)

R E S E T

*Geometrie
naturali*

NATURAL GEOMETRIES

Reset



Incontri **sorprendenti**

SURPRISING MEETINGS

La natura vive e si trasforma anche in base alle necessità e alle condizioni di un determinato spazio. L'uomo questo lo sa e le porte della collezione Reset rappresentano proprio il tentativo, riuscito, di valorizzare le venature del legno abbinandole a geometrie e sinuosità realizzate grazie ad incisioni o all'inserimento di vetri con luce passante. Nascono, così, ante dal design fortemente contemporaneo che acquistano ancora più fascino laddove la laccatura interviene con moderazione per donare all'occhio la prova tangibile che l'incontro tra elementi diversi sa creare risultati sorprendenti.

NATURE ALSO LIVES AND TRANSFORMS ACCORDING TO THE NEEDS AND CONDITIONS OF A GIVEN SPACE. MAN KNOWS THIS AND THE DOORS OF THE RESET COLLECTION REPRESENT A SUCCESSFUL ATTEMPT TO ENHANCE THE GRAIN OF THE WOOD, COMBINING IT WITH GEOMETRIES AND SINUOSITY CREATED BY ENGRAVINGS OR THE INSERTION OF GLASS. THESE DOORS WITH A STRONGLY CONTEMPORARY DESIGN ARE BORN, WHICH ACQUIRE EVEN MORE CHARM WHERE THE LACQUERING INTERVENES WITH MODERATION TO GIVE THE EYE THE TANGIBLE PROOF THAT THE ENCOUNTER BETWEEN DIFFERENT ELEMENTS CAN CREATE SURPRISING RESULTS.

RS04-R

FINITURA · FINISH
Frassino Laccato Tortora

TELAIO · FRAME
TS

MANIGLIA · HANDLE
Bordeaux



RS04-R

FINITURA · FINISH
Frassino Laccato Bianco Poro

TELAIO · FRAME
TT

MANIGLIA · HANDLE
Bordeaux



RS04-I

FINITURA · FINISH
Rovere Natural Tinto Effetto Naturale

TELAIO · FRAME
RS

MANIGLIA · HANDLE
Bordeaux

H PORTA · H DOOR
270 cm

RS04-V

FINITURA · FINISH
Rovere Natural Tinto Effetto Naturale

TELAIO · FRAME
RS

MANIGLIA · HANDLE
Bordeaux

H PORTA · H DOOR
270 cm





RS05-V

FINITURA · FINISH
Laccato Ghiaccio

TELAIO · FRAME
RS

MANIGLIA · HANDLE
Bordeaux

H PORTA · H DOOR
210 cm





RS05-I

FINITURA · FINISH
Frassino Tinto Quercia Dark

TELAIO · FRAME
TT

MANIGLIA · HANDLE
Bordeaux



RS05-R

FINITURA · FINISH
Rovere Laccato Blu

TELAIO · FRAME
TT

MANIGLIA · HANDLE
Bordeaux



RS06-R

FINITURA · FINISH
Frassino Laccato Ghiaccio

TELAIO · FRAME
TS

MANIGLIA · HANDLE
Bordeaux



RS06-I

FINITURA · FINISH
Rovere Natural Patinato Bianco Neve

TELAIO · FRAME
RS

MANIGLIA · HANDLE
Bordeaux

H PORTA · H DOOR
210 cm

RS06-V

FINITURA · FINISH
*Rovere Natural
Patinato Bianco Neve*

TELAIO · FRAME
RS

MANIGLIA · HANDLE
Bordeaux

H PORTA · H DOOR
210 cm



RS06-V

FINITURA · FINISH
Frassino Patinato Grigio Evo

TELAIO · FRAME
TT

MANIGLIA · HANDLE
Bordeaux



RS07-V

FINITURA · FINISH
Rovere Laccato Acquamarina

TELAIO · FRAME
TS

MANIGLIA · HANDLE
Leeds



RS07-I

FINITURA · FINISH
Frassino Tinto Nocciola

TELAIO · FRAME
TN

MANIGLIA · HANDLE
Leeds



RS07-R

FINITURA · FINISH
Frassino Laccato Grigio

APERTURA · OPENING
Scorrevole esterno muro SEM-T

MANIGLIA · HANDLE
Vaschetta KM-MT

H PORTA · H DOOR
210 cm



RS08-V

FINITURA · FINISH
Frassino Tinto Caffè

TELAIO · FRAME
RS

MANIGLIA · HANDLE
Helsinki

H PORTA · H DOOR
270 cm



RS08-R

FINITURA · FINISH
Frassino Laccato Tortora

TELAIO · FRAME
TN

MANIGLIA · HANDLE
Bordeaux



RS08-I

FINITURA · FINISH
Rovere Laccato Bianco Poro

TELAIO · FRAME
TN

MANIGLIA · HANDLE
Bordeaux



RS09-I

FINITURA · FINISH
Rovere Natural Patinato Nocciola

TELAIO · FRAME
TN

MANIGLIA · HANDLE
Bordeaux



RS09-V

FINITURA · FINISH
Laccato Candy

TELAIO · FRAME
TN

MANIGLIA · HANDLE
Bordeaux



RS09-R

FINITURA · FINISH
Frassino Laccato Bianco Poro

TELAIO · FRAME
RS

MANIGLIA · HANDLE
Bordeaux

H PORTA · H DOOR
250 cm

RS09-V

FINITURA · FINISH
Frassino Laccato Bianco Poro

TELAIO · FRAME
RS

MANIGLIA · HANDLE
Bordeaux

H PORTA · H DOOR
250 cm

RS15-V

FINITURA · FINISH
*Frassino Patinato
Bianco Neve*

TELAIO · FRAME
*Doppia scorrevole
interno passata*

MANIGLIA · HANDLE
MAN-Q20-L

H PORTA · H DOOR
210 cm



RS15-V

FINITURA · FINISH
Laccato Acquamarina

TELAIO · FRAME
TS

MANIGLIA · HANDLE
Bordeaux



RS15-I

FINITURA · FINISH
Rovere Tinto Mascara

TELAIO · FRAME
TT

MANIGLIA · HANDLE
Bordeaux





RS10-F

FINITURA · FINISH *Frassino Tinto Grigio Evo*
TELAIO · FRAME *TN*
MANIGLIA · HANDLE *Sochi*
VETRO · GLASS *C16-Q Grigio*

RS06-R

FINITURA · FINISH *Frassino Tinto Grigio Evo*
TELAIO · FRAME *TN*
MANIGLIA · HANDLE *Sochi*



RS10

FINITURA · FINISH
Frassino Tinto Mascara
TELAIO · FRAME
TN
MANIGLIA · HANDLE
Flux
H PORTA · H DOOR
210 cm

RS10-F

FINITURA · FINISH
Frassino Tinto Mascara
TELAIO · FRAME
TN
MANIGLIA · HANDLE
Flux
H PORTA · H DOOR
210 cm
VETRO · GLASS
Satinato Extrachiaro

Rovere **tinto** spazzolato

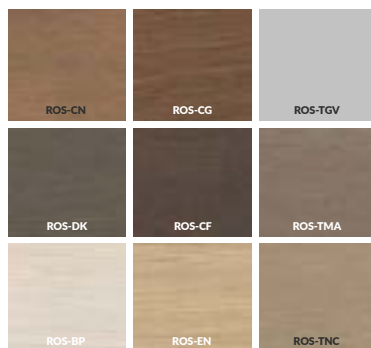

Rovere Natural **tinto** spazz.



Rovere **laccato** spazzolato



Rovere Natural **patinato** spazz.

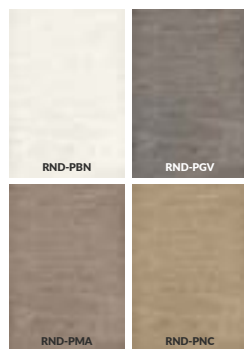

Frassino **tinto** spazzolato

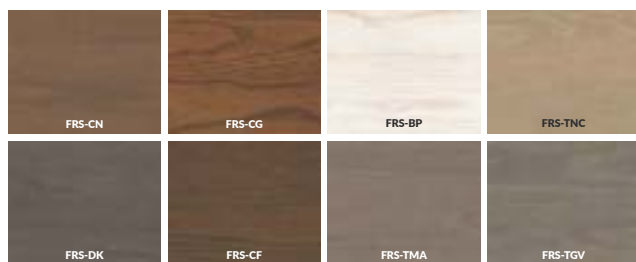

Frassino **laccato** spazzolato



Frassino **patinato** spazz.



Laccato **opaco**



Laccato **effetto seta**

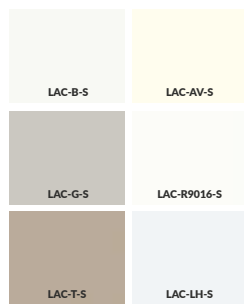

Porta cieca piana tamburata, disponibile nelle versioni cieca pantografata con semplici incisioni, con fresate in basso-rilievo o con punti luce semi trasparenti in metacrilato color bianco latte. Le versioni sono a battente, scorrevole, pieghevole simmetrica (DUO) o pieghevole asimmetrica 1/3-2/3 (PIEGO). L'anta in tamburato costituito da un telaio perimetrale esterno in massello di abete di circa mm 37x32, essiccato, epurato da nodi e canastro, giuntato a pettine, riempitivo in struttura alveolare trattata antitarlo e antimuffa, rivestimento in pannelli di fibra di legno a media densità di mm 6. Facciate placcate in tranciato pregiato di Frassino orizzontale a fiamme contrapposte, Rovere rigato orizzontale o Rovere orizzontale Natural, da 0,5 mm; bordatura perimetrale su tre lati con bordo in legno in essenza simile alle facciate. Porta finestrata intelaiata con montanti e traverse in listellare impiallacciate in Frassino o in Rovere. Il vetro da 6 mm è trattenuto nella fresata degli elementi dell'anta da una particolare guarnizione coestrusa in materiale plastico. Il vetro può essere sostituito previa rimozione della traversa superiore. Le tinte, i patinati o le laccature a poro aperto sono finiture all'acqua. Ferramenta: tre cerniere a scomparsa regolabili su 3 assi o le classiche anuba, serratura patent piccola (solo scrocco) frontale 18 mm ingresso 50 mm disponibili nelle finiture cromato opaco, cromato lucido e ottone lucido, o serratura magnetica nelle finiture cromo satinato, cromo lucido o bianca. Spessore totale anta 44 mm.

HOLLOW CORE FLAT BLIND DOOR, AVAILABLE IN PANTOGRAPHED BLIND VERSIONS WITH SIMPLE ENGRAVINGS, WITH MILLED LOW-RELIEF OR WITH SEMI-TRANSPARENT LIGHT POINTS IN MILKY WHITE METHACRYLATE. THE VERSIONS ARE HINGED, SLIDING, SYMMETRICAL FOLDING (DUO) OR ASYMMETRICAL FOLDING 1/3-2/3 (FOLD). THE HONEYCOMB SANDWICH DOOR CONSISTS OF AN EXTERNAL PERIMETER FRAME IN SOLID FIR OF ABOUT 37X32 MM, DRIED, CLEANED OF KNOTS AND CANES, FINGER-JOINED, FILLER IN HONEYCOMB STRUCTURE TREATED ANTI-MILDEW AND ANTI-MILDEW, COVERING IN PANELS OF MEDIUM DENSITY WOOD FIBER OF 6 MM. FACADES CLAD IN HIGH-QUALITY VENEER OF HORIZONTAL STRIPED OAK OR HORIZONTAL NATURAL OAK, 0.5 MM; PERIMETER EDGING ON THREE SIDES WITH WOODEN EDGE IN WOOD SIMILAR TO THE FACADES. FRAMED WINDOW DOOR WITH UPRIGHTS AND CROSSBARS IN BLOCKBOARD VENEERED WITH ASH OR OAK. THE 6 MM GLASS IS HELD IN THE MILLED DOOR ELEMENTS BY A SPECIAL CO-EXTRUDED GASKET IN PLASTIC MATERIAL. THE GLASS CAN BE REPLACED AFTER REMOVING THE UPPER CROSSPIECE. COLOURS, PATINATES OR OPEN-PORE LACQUERS ARE WATER-BASED FINISHES. HARDWARE: THREE CONCEALED HINGES ADJUSTABLE ON 3 AXES OR THE CLASSIC ANUBA, SMALL PATENT LOCK (ONLY LATCH) FRONTAL 18 MM ENTRANCE 50 MM AVAILABLE IN MATT CHROME, POLISHED CHROME AND POLISHED BRASS FINISHES, OR MAGNETIC LOCK IN SATIN CHROME, POLISHED CHROME OR WHITE FINISHES. TOTAL DOOR THICKNESS 44 MM.

RS4-I



RS5-I



RS4-V



RS5-V



RS4-R



RS5-R



RS6-I



RS7-I



RS8-I



RS9-I



RS15-I



RS10



RS6-V



RS7-V



RS8-V



RS9-V



RS15-V



RS10-F



RS6-R



RS7-R



RS8-R



RS9-R



RS15-R





SOLOLEGNO



LOCATION: ROCCHES DEL ROERO - POCAPAGLIA (CN)

E S S E N Z A

*L'essenziale
è "visibile"
agli occhi*

THE ESSENTIAL IS
"VISIBLE" TO THE EYES

ESSENZA

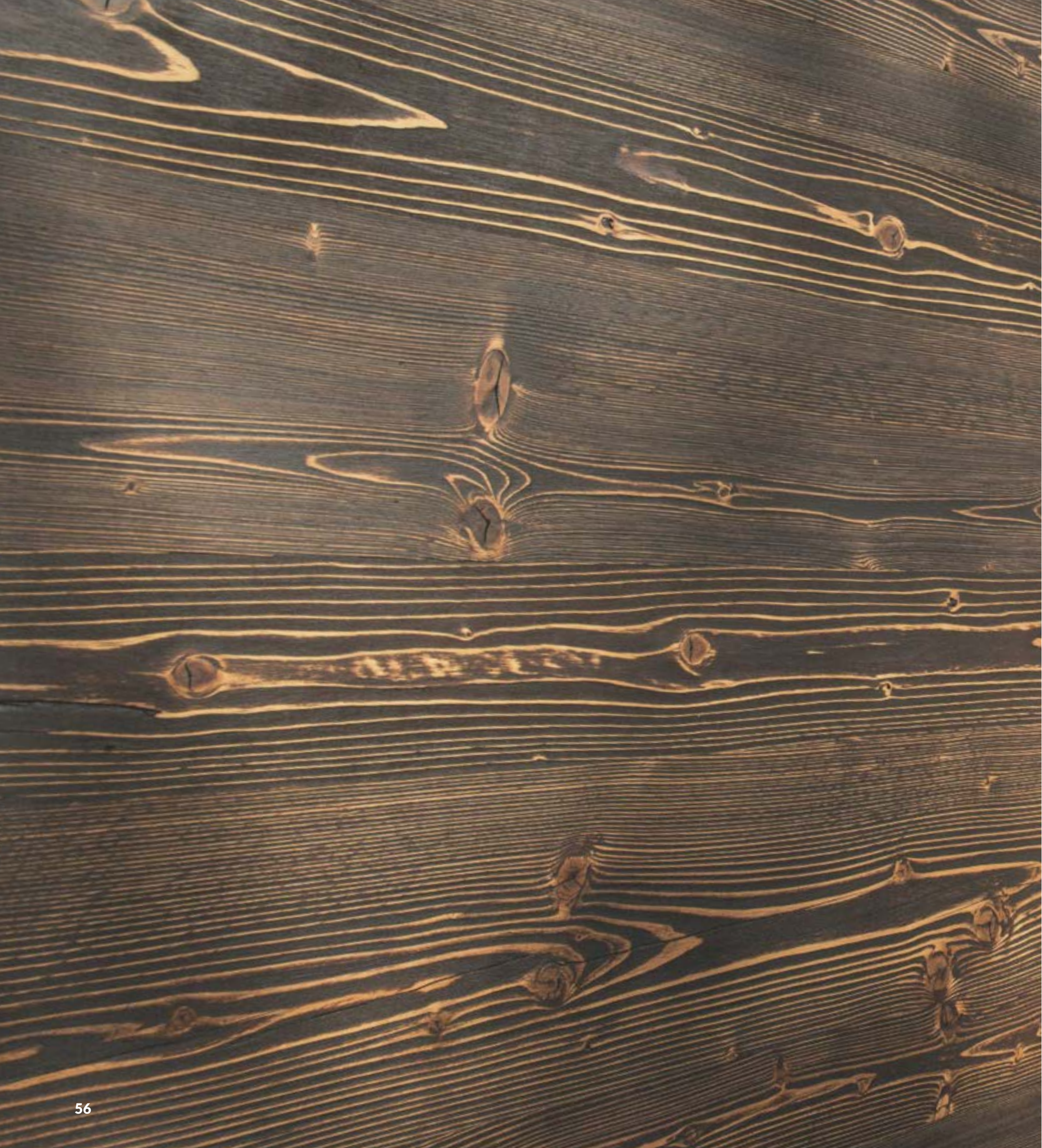

Sua maestà **il legno**

WOOD: THE KING

Un bosco selvaggio, "essenza" di una natura incontaminata, dove a farla da padrone è sua maestà il legno. Nella linea Essenza il protagonista è lui, che ci "parla" e ci emoziona. Grezzo, naturale, dice di tutto di sé, con i suoi nodi e le sue bellissime venature a vista. Prive di telaio, le ante sono disponibili nella versione Rovere Touch e Abete Touch. Un prodotto unico per qualità e stile, il trait d'union perfetto per un arredamento moderno e di design.

A WILD WOOD, "ESSENCE" OF AN UNCONTAMINATED NATURE, WHERE THE WOOD IS THE KING. IN THE ESSENZA LINE, THE PROTAGONIST IS HIM, WHO "SPEAKS" TO US AND EXCITES US. RAW, NATURAL, IT SAYS EVERYTHING ABOUT HIMSELF, WITH HIS KNOTS AND HIS BEAUTIFUL VEINS IN SIGHT. WITHOUT A FRAME, THE SWINGS ARE AVAILABLE IN THE TOUCH OAK AND TOUCH SPRUCE VERSIONS. A UNIQUE PRODUCT FOR QUALITY AND STYLE, THE PERFECT TRAIT D'UNION FOR A MODERN AND DESIGN



ES00

FINITURA · FINISH
Rovere Touch Canaletto

TELAIO · FRAME
RS

MANIGLIA · HANDLE
Sochi

H PORTA · H DOOR
210 cm

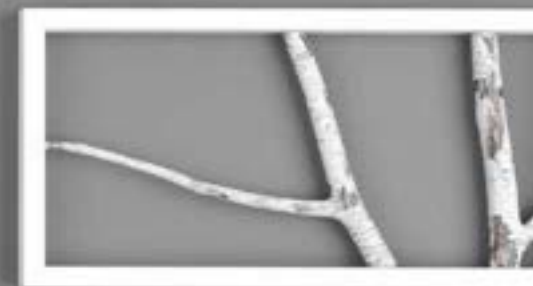

ES00

FINITURA · FINISH
Abete Touch Effetto Naturale

TELAIO · FRAME
RS

MANIGLIA · HANDLE
Sochi

H PORTA · H DOOR
270 cm



LOCATION: ROCHE DEL ROERO - POCAPAGLIA (CN)



ES00

FINITURA · FINISH
Rovere Touch Effetto Naturale

TELAIO · FRAME
RS

MANIGLIA · HANDLE
Sochi

H PORTA · H DOOR
270 cm



ES00

FINITURA · FINISH
Abete Touch Bianco

TELAIO · FRAME
*Scorrevole esterno muro
mod. Evasione*

MANIGLIA · HANDLE
MANQ-116

H PORTA · H DOOR
230 cm



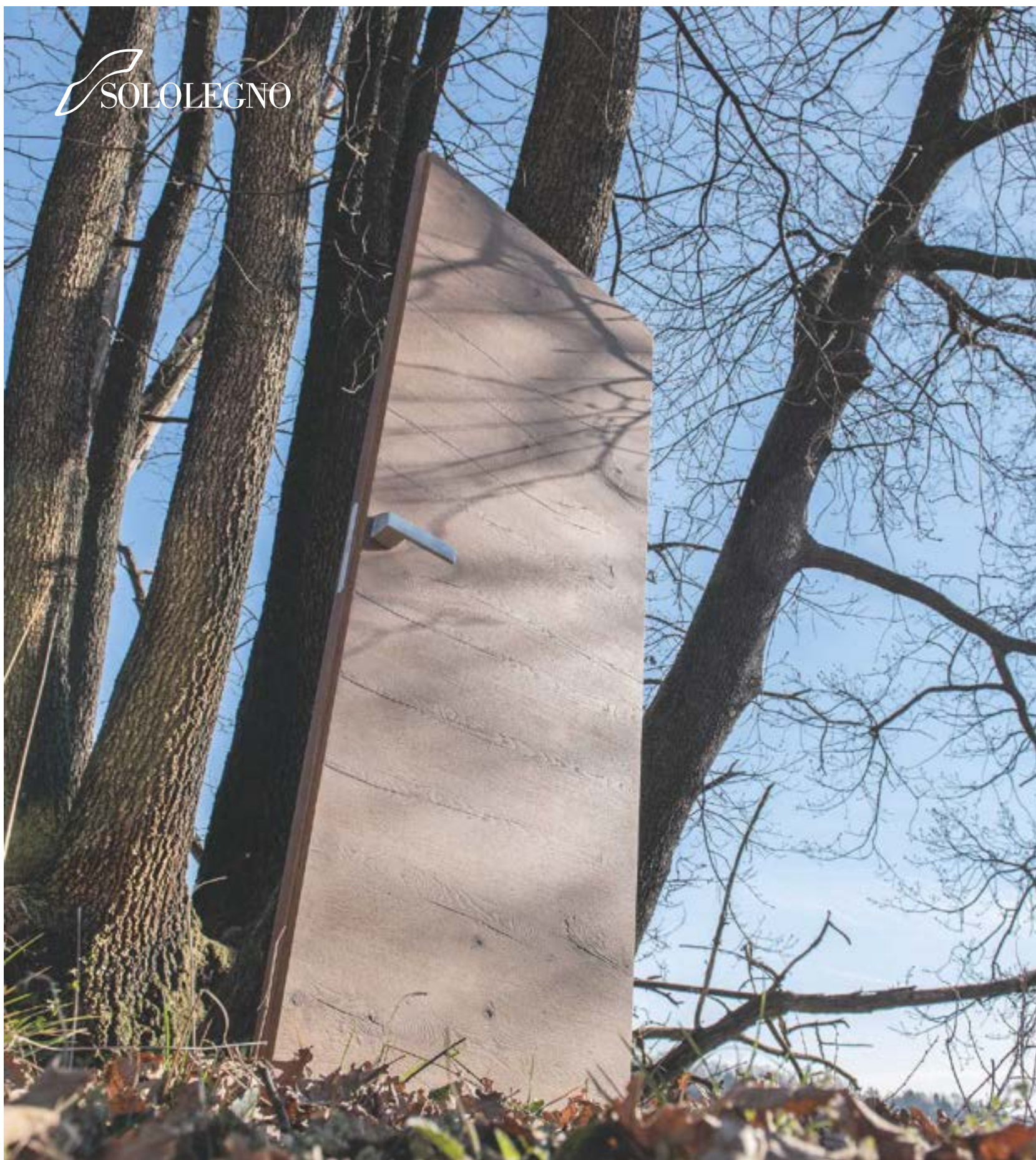

LOCATION: ROCHE DEL ROERO - POCAPAGLIA (CN)

ES00

Rovere Touch Effetto Naturale

**ES00**

Abete Touch Bianco

**ES00**

Abete Touch Effetto Naturale

**ES00**

Abete Touch Cognac



Porta cieca piana tamburata, a battente, scorrevole interno o esterno muro. L'anta tamburata con telaio perimetrale esterno in massello di abete di circa mm 37x32, essiccato, epurato da nodi e canastro, giuntato a pettine, riempitivo in struttura alveolare trattata antitarlo e antimuffa, rivestimento in pannelli di fibra di legno a media densità di 6 mm di spessore. Le facciate sono rivestite in tranciato pregiato di Rovere e Abete Touch supportato, con nodi e crepe a vista, da 1-1,5 mm di spessore. Ferramenta: tre cerniere a scomparsa regolabili su 3 assi, serratura patent piccola (solo scrocco) frontale 18 mm ingresso 50 mm disponibili nelle finiture cromato opaco, cromato lucido e ottone lucido, o serratura magnetica nelle finiture cromo satinato, cromo lucido o bianca. Spessore totale anta 44 mm.

ES00

Rovere Touch Canaletto

**ES00**

Abete Touch Grafite

**ES00**

Abete Touch Petrolio

**ES00**

Abete Touch Bruciato



VENEERED FLAT DOOR, HINGED, SLIDING INSIDE OR OUTSIDE WALL. THE HONEYCOMB SANDWICH DOOR WITH EXTERNAL PERIMETER FRAME IN SOLID FIR WOOD OF ABOUT 37X32 MM, DRIED, CLEANED OF KNOTS, FINGER-JOINED, FILLER IN HONEYCOMB STRUCTURE TREATED AGAINST MOTH AND MOULD, COVERING IN MEDIUM DENSITY WOOD FIBRE PANELS OF 6 MM THICKNESS. THE SURFACES ARE COVERED WITH HIGH-QUALITY SHEETS OF OAK AND FIR TOUCH SUPPORTED, WITH KNOTS AND VISIBLE CRACKS, FROM 1-1.5 MM THICK. HARDWARE: THREE NOT VISIBLE HINGES ADJUSTABLE ON 3 AXES, SMALL PATENT LOCK (LATCH ONLY), FRONT ENTRY 18 MM AVAILABLE IN MATT CHROME, POLISHED CHROME AND POLISHED BRASS FINISHES, OR MAGNETIC LOCK IN SATIN CHROME, POLISHED CHROME OR WHITE FINISHES. SWING THICKNESS 44 MM.

 SOLOLEGNO



LOCATION: CANTINA CASCINA ADELAIDE - BAROLO (CN)

C O N C E R T O

*Sinfonie
d'orchestra*

ORCHESTRA SYMPHONIES

concerto



Sapienti integrazioni

WISE ADDITIONS

I risultati raggiunti grazie al lavoro di squadra hanno un sapore speciale. E così le porte della collezione Concerto conquistano proprio con la fusione di elementi diversi. Legno, ovviamente, ma anche vetro e alluminio, capaci di esaltare, integrandosi sapientemente, incisioni e disegni dove le venature del legno, in un alternarsi di movimenti verticali e orizzontali, non solo giocano un ruolo determinante ma caratterizzano il prodotto stesso. D'altronde è la vita stessa ad essere fatta di improvvisi cambi di direzione, meglio ricordarlo!

THE RESULTS ACHIEVED THROUGH TEAMWORK HAVE A SPECIAL FLAVOUR. AND SO THE DOORS OF THE CONCERTO COLLECTION WIN WITH THE FUSION OF DIFFERENT ELEMENTS. WOOD, OF COURSE, BUT ALSO GLASS, ALUMINIUM OR GLOSSY INSERTS, CAPABLE OF EXALTING, SKILFULLY INTEGRATING, ENGRAVINGS AND DESIGNS WHERE THE VEINS OF THE WOOD, IN AN ALTERNATION OF VERTICAL AND HORIZONTAL MOVEMENTS, NOT ONLY PLAY A DECISIVE ROLE BUT CHARACTERIZE THE PRODUCT ITSELF. ON THE OTHER HAND, LIFE ITSELF IS MADE UP OF SUDDEN CHANGES OF DIRECTION, BETTER TO REMEMBER!

LP03

FINITURA · FINISH *Frassino Tinto Canaletto*
TELAIO · FRAME *T5*
MANIGLIA · HANDLE *Bordeaux*
VETRO · GLASS *C2-FC grigio*



LP31

FINITURA · FINISH
*Frassino Patinato
Bianco Neve*
TELAIO · FRAME
TT
MANIGLIA · HANDLE
Bordeaux
H PORTA · H DOOR
210 cm
VETRO · GLASS
*Satinato
Extrachiaro*





LP32

FINITURA · FINISH *Rovere Natural Tinto Cognac*
TELAIO · FRAME **TN**
MANIGLIA · HANDLE *Bordeaux*
VETRO SINTETICO · SYNTHETIC GLASS *Grigio*



LP32

FINITURA · FINISH
Frassino Patinato Grigio Evo
TELAIO · FRAME
RS
MANIGLIA · HANDLE
Bordeaux
H PORTA · H DOOR
240 cm
VETRO SINTETICO · SYNTHETIC GLASS
Grigio

C O N C E R T O





SOLOLEGNO

C O N C E R T O

LP31

FINITURA · FINISH *Rovere Tinto Mascara*

TELAIO · FRAME *TS*

MANIGLIA · HANDLE *Bordeaux*

VETRO · GLASS *Satinato Extrachiaro*



LOCATION: ROCCHES DEL ROERO - POCAPAGLIA (CN)



LP16

FINITURA · FINISH
Rovere Tinto Caffè

TELAIO · FRAME
T5

MANIGLIA · HANDLE
Bordeaux

H PORTA · H DOOR
210 cm

INSERTO · INSERT
Nero Lucido





LP17

FINITURA · FINISH
Frassino Tinto Grigio Evo

TELAIO · FRAME
TN

MANIGLIA · HANDLE
Bordeaux

H PORTA · H DOOR
210 cm

INSERTO · INSERT
Grigio Scuro Lucido

LP17

FINITURA · FINISH *Frassino Laccato Grigio*

TELAIO · FRAME **TN**

MANIGLIA · HANDLE *Glasgow*

INSERTO · INSERT *Grigio Chiaro Lucido*





LP01

FINITURA · FINISH
Rovere Tinto Bianco perlato

TELAIO · FRAME
RS

MANIGLIA · HANDLE
Flux

H PORTA · H DOOR
210 cm



LP01

FINITURA · FINISH
Rovere Tinto Nocciola

TELAIO · FRAME
TS

MANIGLIA · HANDLE
Bordeaux



LP02

FINITURA · FINISH
Frassino Laccato Bianco Poro

TELAIO · FRAME
TT

MANIGLIA · HANDLE
Bordeaux

FILETTI · FILLETS
Alluminio



LP04

FINITURA · FINISH
Frassino Tinto Cognac

TELAIO · FRAME
TN

MANIGLIA · HANDLE
Bordeaux

FILETTI · FILLETS
Alluminio





Rovere **tinto** spazzolato

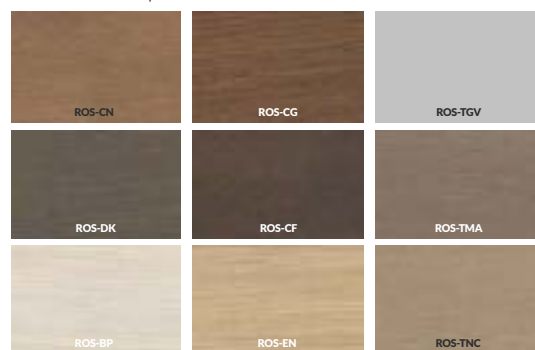

Rovere **laccato** spazzolato



Frassino **tinto** spazzolato

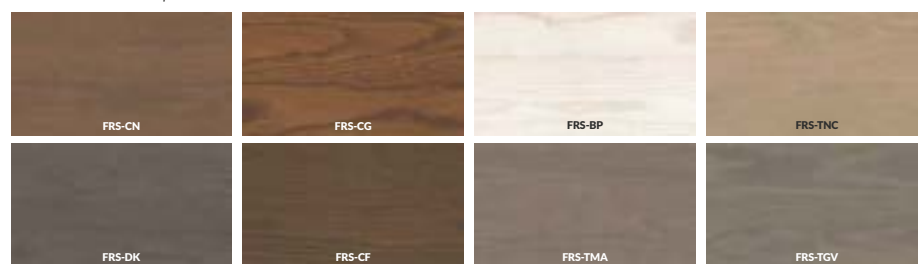

Frassino **laccato** spazzolato

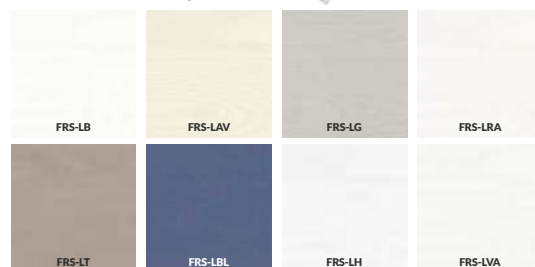

Laccato **opaco**



Rovere Natural **tinto** spazz.

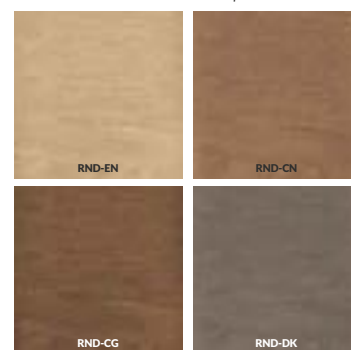

Rovere Natural **patinato** spazz.

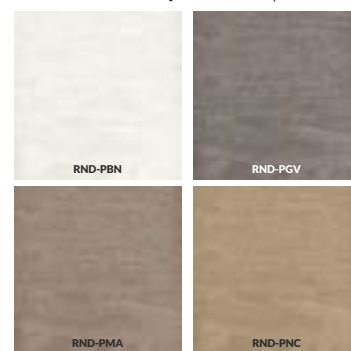

Frassino **patinato** spazz.



Laccato **effetto seta**

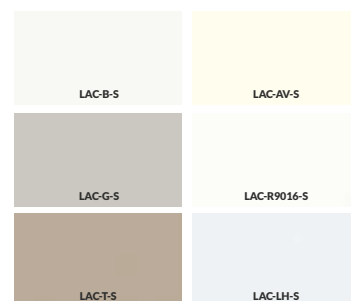

Porta cieca, disponibile nelle versioni a battente, scorrevole interno o esterno muro, pieghevole simmetrica (DUO) o pieghevole asimmetrica 1/3-2/3 (PIEGO).

L'anta costituita da due montanti laterali in listellare e un pannello centrale tamburato leggermente ribassato rivestito in tranciato pregiato di Frassino orizzontale a fiamme contrapposte, Rovere orizzontale Natural, mentre i montanti in tranciato con venature verticali. Alcuni modelli hanno inserti orizzontali lucidi tono su tono. Le tinte, i patinati o le laccature a poro aperto sono finiture all'acqua.

Per le versioni finestrate il vetro di varie dimensioni è portante. Ferramenta: tre cerniere a scomparsa regolabili su 3 assi o le classiche anuba, serratura patent piccola (solo scrocco) frontale 18 mm ingresso 50 mm disponibili nelle finiture cromato opaco, cromato lucido e ottone lucido, o serratura magnetica nelle finiture cromo satinato, cromo lucido o bianca. Spessore totale anta 44 mm.

SMOOTH DOOR, SLIDING INSIDE OR OUTSIDE WALL, SYMMETRICAL FOLDING (DUO) OR ASYMMETRICAL FOLDING 1/3-2/3 (FOLD) VERSIONS. THE DOOR CONSISTS OF TWO SIDE UPRIGHTS IN BLOCKBOARD AND A SLIGHTLY LOWERED HONEYCOMB CORE CENTRAL PANEL COVERED IN HIGH-QUALITY VENEER OF HORIZONTAL ASH WITH OPPOSING FLAMES, HORIZONTAL OAK NATURAL, WHILE THE UPRIGHTS IN VENEER WITH VERTICAL VEINS. SOME MODELS HAVE SHINY HORIZONTAL INSERTS.

THE COLOURS, PATINATES OR OPEN-PORE LACQUERS ARE WATER-BASED FINISHES. FOR THE WINDOWED VERSIONS, THE GLASS OF VARIOUS SIZES HAS A SUPPORTING FUNCTION. HARDWARE: THREE NOT VISIBLE HINGES ADJUSTABLE ON 3 AXES OR THE CLASSIC ANUBA, SMALL PATENT LOCK (ONLY LATCH) FRONTAL 18 MM ENTRANCE 50 MM AVAILABLE IN MATT CHROME, POLISHED CHROME AND POLISHED BRASS FINISHES, OR MAGNETIC LOCK IN SATIN CHROME, POLISHED CHROME OR WHITE FINISHES. SWING THICKNESS 44 MM.

LP01



LP02



LP03



LP04



Inserti **lucidi**

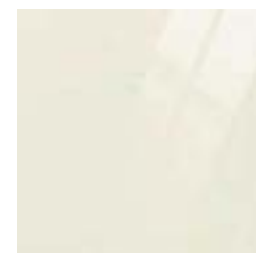

LP16



LP17



LP18



LP19

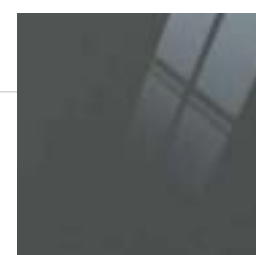
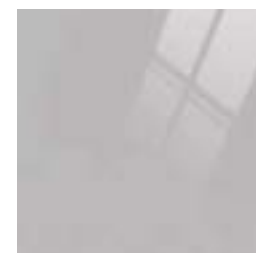
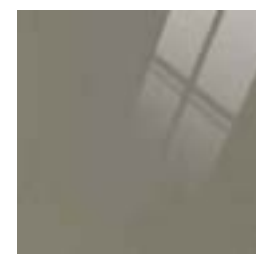

LP31



LP32



Il modello LP32 può essere personalizzato con 4 tipologie di vetro sintetico: extrachiaro lucido trasparente, extrachiaro satinato, grigio lucido trasparente e grigio satinato.

THE LP32 MODEL CAN BE CUSTOMIZED WITH 4 TYPES OF SYNTHETIC GLASS: TRANSPARENT EXTRA CLEAR, SATIN EXTRA-CLEAR, TRANSPARENT GLOSS GRAY AND SATIN GRAY.

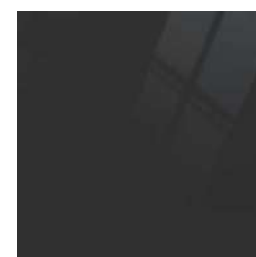

Per verificare le disponibilità degli abbinamenti finitura/inserto consulta pagina 211



SOLOLEGNO



LOCATION: ROCHE DEL ROERO - POCAPAGLIA (CN)

I D E A L E

*Spontanee
direzioni*

SPONTANEOUS DIRECTIONS

Ideale

Movimenti alternati

ALTERNATE MOVEMENTS

*Seguire con l'occhio la venatura del legno
e trovarsi improvvisamente a cambiare direzione.*

Una volta, un'altra e un'altra ancora.

*È l'effetto originale che generano le porte della collezione
Ideale. Un "balletto" sempre nuovo creato su ante
cieche lisce o impreziosite da incisioni e filetti, sinuosi o
lineari, anche arricchiti da Swarovski. Questi elementi
stuzzicano, ma non devono distrarre: la vera forza resta
la naturale e spontanea alternanza di pannelli in legno
con venature orientate in modo diverso che conferiscono
all'intera porta un movimento sorprendente e naturale.*

FOLLOW THE GRAIN OF THE WOOD WITH YOUR EYE AND SUDDENLY FIND YOURSELF CHANGING DIRECTION. IT IS THE ORIGINAL EFFECT THAT GENERATE THE DOORS OF THE IDEALE COLLECTION. AN EVER NEW "BALLET" CREATED ON DOORS THAT ARE SMOOTH OR EMBELLISHED WITH ENGRAVINGS, SINUOUS OR LINEAR, ALSO EMBELLISHED WITH SWAROVSKI CRYSTALS. THESE ELEMENTS EXCITE: THE REAL STRENGTH REMAINS THE NATURAL AND SPONTANEOUS ALTERNATION OF WOODEN VEINS THAT GIVE THE ENTIRE DOOR A SURPRISING AND NATURAL MOVEMENT.



NVT

FINITURA · FINISH *Frassino Patinato Grigio Evo*
TELAIO · FRAME *TN*
MANIGLIA · HANDLE *Bordeaux*
H PORTA · H DOOR *210 cm*



NVT

FINITURA · FINISH
Frassino Tinto
Bianco Perlato

TELAIO · FRAME
TT

MANIGLIA · HANDLE
Bordeaux

H PORTA · H DOOR
210 cm

NPO

FINITURA · FINISH
Rovere Natural Tinto Canaletto
TELAIO · FRAME *TN*
MANIGLIA · HANDLE *Phoenix*



NPO

FINITURA · FINISH
Rovere Natural Patinato Nocciola
TELAIO · FRAME *TT*
MANIGLIA · HANDLE *Helsinki*



NPO

FINITURA · FINISH
Rovere Natural Patinato Mascara
TELAIO · FRAME
RS
MANIGLIA · HANDLE
Bordeaux
H PORTA · H DOOR
270 cm





NPO

FINITURA · FINISH *Frassino Laccato Ghiaccio*

TELAIO · FRAME *Scorrevole esterno muro mod. Evasione*

MANIGLIA · HANDLE *MAN-Q20*

H PORTA · H DOOR *250 cm*

IS07

FINITURA · FINISH
Frassino Patinato
Bianco Neve

TELAIO · FRAME

TN

MANIGLIA · HANDLE
Phoenix

INSERTO · INSERT
Swarovski





IS04

FINITURA · FINISH
Rovere Tinto Cognac

TELAIO · FRAME
TN

MANIGLIA · HANDLE
Bordeaux

H PORTA · H DOOR
210 cm

IS05

FINITURA · FINISH
Rovere Tinto Bianco Perlato
TELAIO · FRAME *TT*
MANIGLIA · HANDLE *Helsinki*



IS06

FINITURA · FINISH
Frassino Tinto Caffè
TELAIO · FRAME *TT*
MANIGLIA · HANDLE *Helsinki*



IS03

FINITURA · FINISH
Frassino Patinato Grigio Evo

TELAIO · FRAME
TN

MANIGLIA · HANDLE
Flux



RS10-F

FINITURA · FINISH
Rovere Tinto Quercia Dark

TELAIO · FRAME
TS

MANIGLIA · HANDLE
Helsinki

VETRO · GLASS
Grigio



IS03

FINITURA · FINISH
Frassino Tinto Caffè

TELAIO · FRAME
TN

MANIGLIA · HANDLE
Bordeaux

H PORTA · H DOOR
210 cm



ID10

FINITURA · FINISH
Rovere Laccato Bianco Poro

TELAIO · FRAME
TN

MANIGLIA · HANDLE
Bordeaux



ID11

FINITURA · FINISH
Frassino Laccato Acquamarina

TELAIO · FRAME
TN

MANIGLIA · HANDLE
Flux



ID11

FINITURA · FINISH
Frassino Laccato Tortora

TELAIO · FRAME
TN

MANIGLIA · HANDLE
Bordeaux

H PORTA · H DOOR
210 cm





ID12

FINITURA · FINISH
Frassino Patinato Bianco Neve

TELAIO · FRAME
TT

MANIGLIA · HANDLE
Sochi



ID13

FINITURA · FINISH
Frassino Laccato Candy

TELAIO · FRAME
T5

MANIGLIA · HANDLE
Bordeaux

H PORTA · H DOOR
210 cm



ID13

FINITURA · FINISH
Frassino Laccato Bianco Poro

TELAIO · FRAME
TN

MANIGLIA · HANDLE
Phoenix



ID14

FINITURA · FINISH
Rovere Laccato Grigio

TELAIO · FRAME
TT

MANIGLIA · HANDLE
Helsinki





ID3

FINITURA · FINISH
Frassino Laccato Grigio

TELAIO · FRAME

TN

MANIGLIA · HANDLE
Bordeaux

H PORTA · H DOOR
210 cm

ID4

FINITURA · FINISH *Frassino Tinto Bianco Perlato*

TELAIO · FRAME **TT**

MANIGLIA · HANDLE *Helsinki*



ID1

FINITURA · FINISH *Rovere Laccato Blu*

TELAIO · FRAME **TN**

MANIGLIA · HANDLE *Phoenix*



ID2

FINITURA · FINISH

Rovere Tinto Caffè

TELAIO · FRAME

*Scorrevole interno muro
senza telaio*

MANIGLIA · HANDLE

Vaschetta KM-MT

H PORTA · H DOOR

210 cm

SOLOLEGNO



LOCATION: ROCHE DEL ROERO - POCAPAGLIA (CN)

I D E A L E

ID30

FINITURA · FINISH *Rovere Laccato Candy*
TELAIO · FRAME *TS*
MANIGLIA · HANDLE *Helsinki*



I D E A L E



ID28

FINITURA · FINISH *Frassino Tinto Canaletto*
TELAIO · FRAME *TS*
MANIGLIA · HANDLE *Helsinki*

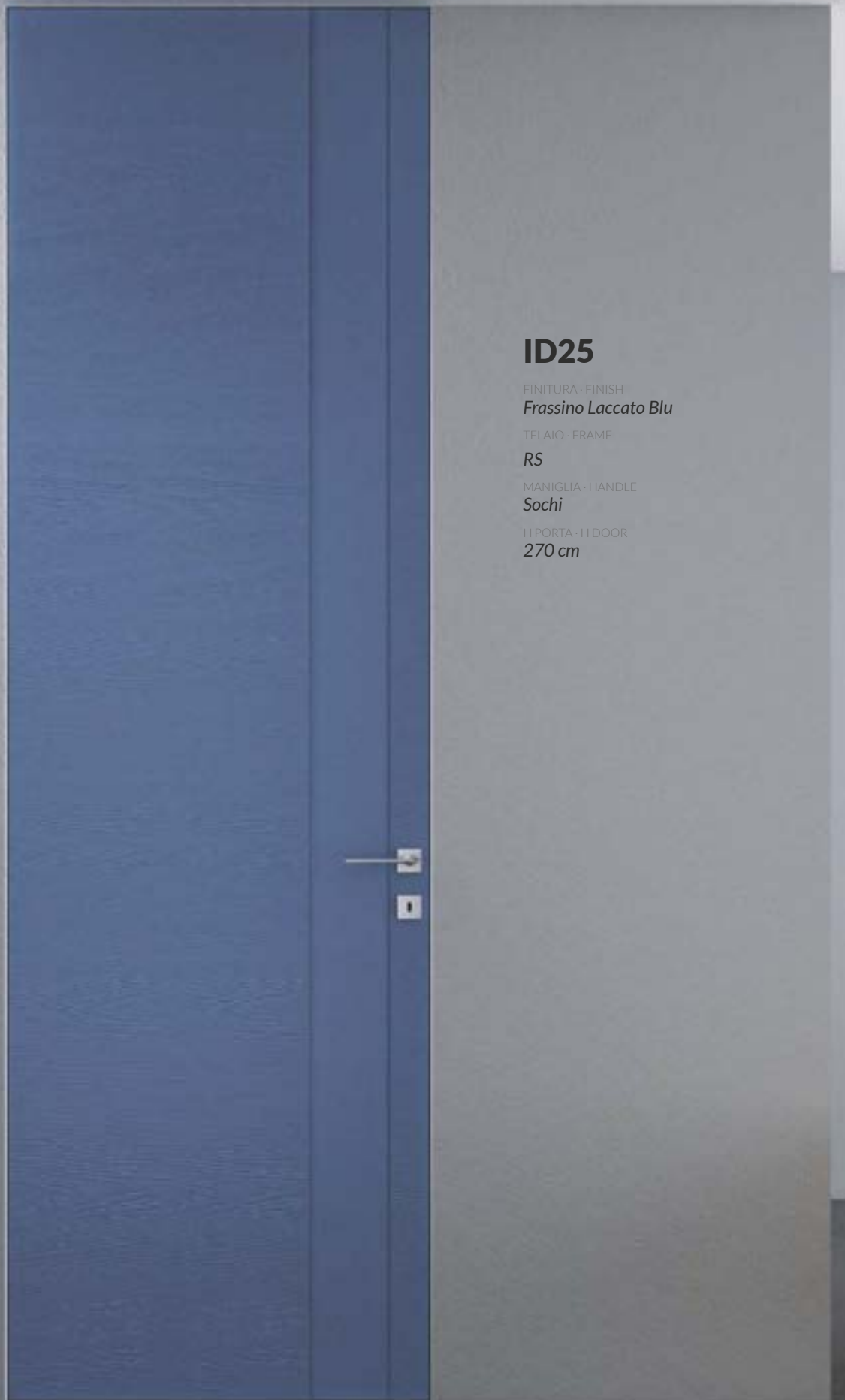

ID25

FINITURA · FINISH
Frassino Laccato Blu
TELAIO · FRAME
RS
MANIGLIA · HANDLE
Sochi
H PORTA · H DOOR
270 cm



I D E A L E

ID23

FINITURA · FINISH
Rovere Laccato Candy
 TELAIO · FRAME *TT*
 MANIGLIA · HANDLE *Helsinki*



ID24

FINITURA · FINISH
Rovere Tinto Cognac
 TELAIO · FRAME *TN*
 MANIGLIA · HANDLE *Phoenix*



ID30

FINITURA · FINISH
Frassino Laccato Cioccolato
 TELAIO · FRAME
RS
 MANIGLIA · HANDLE
Helsinki
 H PORTA · H DOOR
210 cm

Rovere **tinto** spazzolato

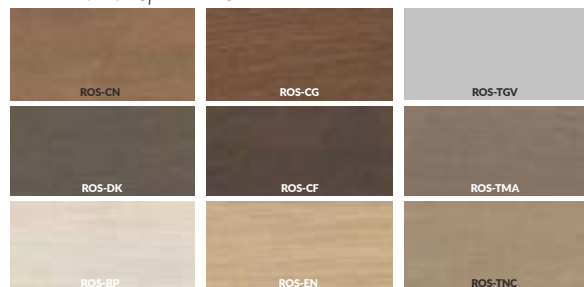

Rovere Natural **tinto** spazzolato

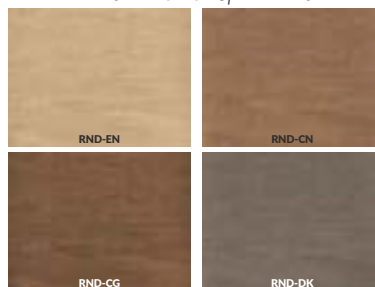

Rovere **laccato** spazzolato

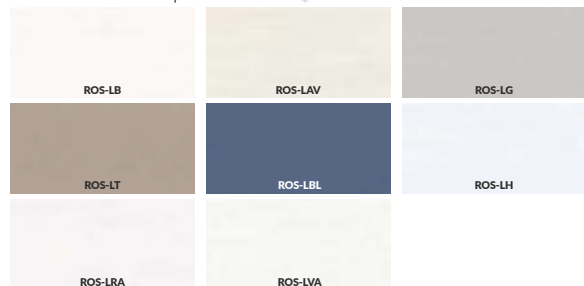

Rovere Natural **patinato** spazzolato

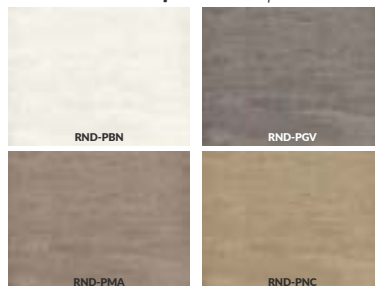

Frassino **tinto** spazzolato

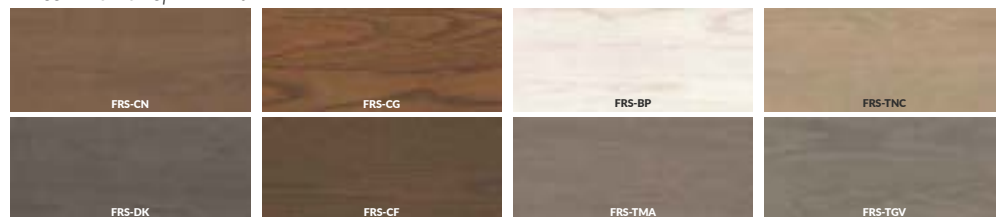

Frassino **laccato** spazzolato

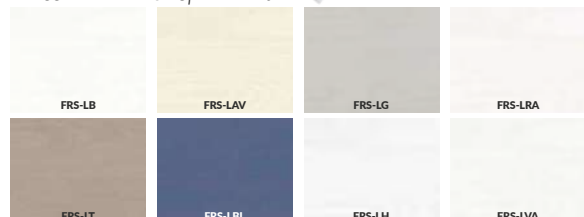

Frassino **patinato** spazzolato

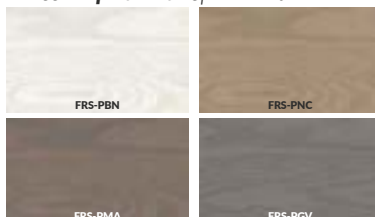

NVT



IS03



NPO



IS04



IS05



Porta cieca piana tamburata, a battente, scorrevole interno o esterno muro, pieghevole simmetrica (DUO) o pieghevole asimmetrica 1/3-2/3 (PIEGO). L'anta tamburata con telaio perimetrale esterno in massello di abete di circa mm 37x32, essiccato, epurato da nodi e canastro, giuntato a pettine, riempitivo in struttura alveolare trattata antitarlo e antimuffa, rivestimento in pannelli di fibra di legno a media densità di 6 mm di spessore. Le facciate placcate in tranciato pregiato di Frassino orizzontale a fiamme contrapposte, Rovere orizzontale rigato o Rovere orizzontale Natural, da 0,5 mm. Versioni lisce, con incisioni o bassorilievi sulle facciate con vari disegni geometrici. Le tinte, i patinati o le laccature a poro aperto sono finiture all'acqua. Ferramenta: tre cerniere a scomparsa regolabili su 3 assi o le classiche anuba, serratura patent piccola (solo scrocco) frontale 18 mm ingresso 50 mm disponibili nelle finiture cromato opaco, cromato lucido e ottone lucido, o serratura magnetica nelle finiture cromo satinato, cromo lucido o bianca. Spessore totale anta 44 mm.

HOLLOW CORE FLAT DOOR, HINGED, SLIDING INSIDE OR OUTSIDE WALL, SYMMETRICAL FOLDING (DUO) OR ASYMMETRICAL FOLDING 1/3-2/3 (FOLD). INTERNAL FRAMEWORK IS MADE IN SOLID FIR OF ABOUT 37X32 MM, DRIED, CLEANED OF KNOTS, FINGER-JOINED, FILLER IN HONEYCOMB STRUCTURE TREATED AGAINST MOTH AND MOULD, COVERING IN MEDIUM DENSITY WOOD FIBRE PANELS OF 6 MM THICKNESS. SURFACE IS MADE OF HIGH-QUALITY VENEER OF HORIZONTAL ASH WITH OPPOSING FLAMES, HORIZONTAL STRIPED OAK OR HORIZONTAL NATURAL OAK, 0.5 MM THICK. SMOOTH VERSIONS OR WITH ENGRAVINGS OR BAS-RELIEFS ON THE SURFACE WITH VARIOUS GEOMETRIC DESIGNS. THE OPEN-PORE COLOURS, PATINATES OR LACQUERS ARE WATER-BASED. HARDWARE: THREE NOT VISIBLE HINGES ADJUSTABLE ON 3 AXES OR THE CLASSIC ANUBA, SMALL PATENT LOCK (ONLY LATCH) FRONTAL 18 MM ENTRANCE 50 MM AVAILABLE IN MATT CHROME, POLISHED CHROME AND POLISHED BRASS FINISHES, OR MAGNETIC LOCK IN SATIN CHROME, POLISHED CHROME OR WHITE FINISHES. SWING THICKNESS 44 MM.

IS06



ID1



ID2



ID3



ID4



ID10



IS07



ID11



ID12



ID13



ID14



ID23



RS10



ID24



ID25



ID27



ID28



ID30



 SOLOLEGNO



LOCATION: BRA (CN)



S I N T E S I

*Per vivere
il presente*

TO LIVE THE PRESENT

Sintesi



Simmetrica **alternanza**

SYMMETRICAL ALTERNATION

Simmetria e alternanza sono le parole d'ordine della collezione Sintesi. Vivi il presente in un gioco di incastri perfetti: montanti e traverse accolgono pannelli centrali in puro legno di frassino, rovere, rovere natural in versione liscia, laccata opaco o seta. Un assemblaggio che vede protagonista il legno, con venature orizzontali e verticali, ma anche il vetro, per un mix di gusto e piacere. Il tutto condito, volendo, con quel tocco di fresatura in più.

SYMMETRY AND ALTERNATION ARE THE PASSWORD OF THE MODERN COLLECTION. LIVE THE PRESENT IN A GAME OF PERFECT JOINTS: UPRIGHTS AND CROSSBARS CONTAIN CENTRAL PANELS IN ASH WOOD, OAK, MATT LACQUERED OR SILK VERSIONS. AN ASSEMBLY IN WHICH THE PROTAGONIST IS WOOD, WITH HORIZONTAL AND VERTICAL VEINS, BUT ALSO GLASS, FOR A MIX OF TASTE AND PLEASURE. ALL SEASONED, IF YOU LIKE, WITH THAT EXTRA TOUCH OF DECORATION.



MD21

FINITURA · FINISH
Frassino Tinto Quercia Dark

TELAIO · FRAME
TN

MANIGLIA · HANDLE
Bordeaux

H PORTA · H DOOR
210 cm

VETRO · GLASS
Grigio



MD21

FINITURA · FINISH
Laccata Acquamarina

TELAIO · FRAME
TN

MANIGLIA · HANDLE
Bordeaux

**MD22**

FINITURA · FINISH
Frassino Tinto Caffè

TELAIO · FRAME
TN

MANIGLIA · HANDLE
Bordeaux

**MD22**

FINITURA · FINISH
Rovere Laccato Grigio

TELAIO · FRAME
TN

MANIGLIA · HANDLE
Bordeaux



S E N T E S I

SOLEGGNO



LOCATION: PIAN MUNÈ - MONVISO (CN)

MD23

FINITURA · FINISH
Rovere Tinto Grigio Evo

TELAIO · FRAME
TN

MANIGLIA · HANDLE
Bordeaux

VETRO · GLASS
Grigio



MD24

FINITURA · FINISH
Rovere Tinto Effetto Naturale

TELAIO · FRAME
TN

MANIGLIA · HANDLE
Bordeaux





MD24

FINITURA · FINISH
Laccata Candy

TELAIO · FRAME
TN

MANIGLIA · HANDLE
Bordeaux

H PORTA · H DOOR
210 cm



MD1

FINITURA · FINISH
Rovere Laccato Bianco Poro

TELAIO · FRAME
T5

MANIGLIA · HANDLE
Bordeaux

H PORTA · H DOOR
210 cm

MD1-F

FINITURA · FINISH
Rovere Laccato Bianco Poro

TELAIO · FRAME
T5

MANIGLIA · HANDLE
Bordeaux

H PORTA · H DOOR
210 cm

VETRO · GLASS
extrachiaro satinato

MD1

FINITURA · FINISH *Laccata Grigio*

TELAIO · FRAME *TT*

MANIGLIA · HANDLE *Bordeaux*



MD5

FINITURA · FINISH *Frassino Tinto Caffè*

TELAIO · FRAME *TN*

MANIGLIA · HANDLE *Flux*

H PORTA · H DOOR *210 cm*

MD5-F

FINITURA · FINISH
Frassino Tinto Caffè

TELAIO · FRAME
TN

MANIGLIA · HANDLE
Flux

H PORTA · H DOOR
210 cm

VETRO · GLASS
Satinato Extrachiaro



MD2

FINITURA · FINISH
Laccata Tortora

TELAIO · FRAME *TT*

MANIGLIA · HANDLE *Bordeaux*



MD3

FINITURA · FINISH
Frassino Patinato Bianco Neve

TELAIO · FRAME *T5*

MANIGLIA · HANDLE *Bordeaux*





Rovere **tinto** spazzolato

ROS-CN	ROS-CG	ROS-TGV
ROS-DK	ROS-CF	ROS-TMA
ROS-BP	ROS-EN	ROS-TNC

Rovere **laccato** spazzolato

ROS-LB	ROS-LAV	ROS-LG
ROS-LT	ROS-LBL	ROS-LH
ROS-LRA	ROS-LVA	

Frassino **tinto** spazzolato

FRS-CN	FRS-CG	FRS-BP	FRS-TNC
FRS-DK	FRS-CF	FRS-TMA	FRS-TGV

Frassino **laccato** spazzolato

FRS-LB	FRS-LAV	FRS-LG	FRS-LRA
FRS-LT	FRS-LBL	FRS-LH	FRS-LVA

Laccato **opaco**

LAC-B-R	LAC-AV-R	LAC-CC-R
LAC-G-R	LAC-T-R	LAC-VA-R
LAC-LH-R	LAC-RA-R	LAC-BL-R
LAC-RS-9010	LAC-RS-9003	LAC-RS-9016

Rovere Natural **tinto** spazz.

RND-EN	RND-CN
RND-CG	RND-DK

Rovere Natural **patinato** spazz.

RND-PBN	RND-PGV
RND-PMA	RND-PNC

Frassino **patinato** spazz.

FRS-PBN	FRS-PNC
FRS-PMA	FRS-PGV

Laccato **effetto seta**

LAC-B-S	LAC-AV-S
LAC-G-S	LAC-R9016-S
LAC-T-S	LAC-LH-S

Porta intelaiata, a battente o scorrevole, con profili perimetrali e/o trasversali costituiti da una struttura in legno listellare di abete rivestiti in tranciato pregiato di Frassino, Rovere e Rovere Natural. Le versioni possono essere cieche o vetrate.

I pannelli in numero diverso e forme a seconda dei modelli sono con un nuovo profilo a gradoni, costituiti da pannelli in fibra di legno di media densità (MDF) da 22 mm, o pannelli squadrati di vari spessori, impiallacciati con il medesimo legno tranciato dei profili perimetrali. Queste porte grazie all'unione dei vari profilati in legno con pannelli e/o vetri, possono dare origine a diversi disegni e varianti. L'assemblaggio avviene tramite spine di legno e incollaggio vinilico. Per le versioni finestrate o con vetro montato la traversa superiore è ancorata ai montanti tramite giunti meccanici. I montanti presentano un profilo lineare moderno che creano la sede per ospitare i pannelli e vetri. I vetri, da 5-6mm, sono contornati da una speciale guarnizione coestrusa che funge da isolamento tra il profilo in legno ed il vetro stesso.

Le tinte, i patinati o le laccature a poro aperto sono finiture all'acqua.

Ferramenta: tre cerniere a scomparsa regolabili su 3 assi o le classiche anuba, serratura patent piccola (solo scrocco) frontale 18 mm ingresso 50 mm disponibili nelle finiture cromato opaco, cromato lucido e ottone lucido, o serratura magnetica nelle finiture cromo satinato, cromo lucido o bianca. Spessore totale anta 44 mm.

FRAMED DOOR, SWING OR SLIDING, WITH PERIMETER AND/OR TRANSVERSE PROFILES CONSISTING OF A FIR WOOD BLOCKBOARD STRUCTURE COVERED WITH HIGH-QUALITY VENEER OF ASH, OAK AND NATURAL OAK. THE VERSIONS CAN BE FLAT OR GLAZED.

THE PANELS, IN DIFFERENT NUMBERS AND SHAPES DEPENDING ON THE MODEL, HAVE A NEW STEPPED PROFILE, CONSISTING OF PANELS IN MEDIUM DENSITY WOOD FIBER (MDF) 22 MM, OR SQUARE PANELS OF VARIOUS THICKNESSES, VENEERED WITH THE SAME WOOD OF THE PERIMETER PROFILES. THESE DOORS, THANKS TO THE UNION OF THE VARIOUS WOODEN PROFILES WITH PANELS AND/OR GLASS, CAN GIVE RISE TO DIFFERENT DESIGNS AND VARIATIONS. THE ASSEMBLY IS MADE USING WOODEN PINS AND VINYL GLUING. FOR THE WINDOW VERSION, THE VERTICAL BARS IS FIXED TO HORIZONTAL BAR USING MECHANICAL JOINTS. THE UPRIGHTS HAVE A MODERN LINEAR PROFILE THAT CREATES THE SEAT TO ACCOMMODATE THE PANELS AND GLASS. THE GLASSES HAVE MM. 6 THICKNESS AND HAVE A SPECIAL CO-EXTRUDED GASKET THAT ACTS AS AN INSULATION BETWEEN THE WOODEN PROFILE AND THE GLASS ITSELF. THE OPEN-PORE COLOURS, PATINATES OR LACQUERS ARE WATER-BASED FINISHES.

HARDWARE: THREE NOT VISIBLE HINGES ADJUSTABLE ON 3 AXES OR THE CLASSIC ANUBA, SMALL PATENT LOCK (ONLY LATCH) FRONTAL 18 MM AVAILABLE IN MATT CHROME, POLISHED CHROME AND POLISHED BRASS FINISHES, OR MAGNETIC LOCK IN SATIN CHROME, POLISHED CHROME OR WHITE FINISHES, SWING THICKNESS 44 MM.

MD1



MD1-F



MD2



MD2-F



MD3



MD3-C



MD3-F



MD5



MD5-F



MD21



MD22



MD23



MD24



 SOLOLEGNO



LOCATION: PIAZZA FORO BOARIO - CUNEO (CN)

L I V I N G

*Anche i sogni
si avverano*

EVEN DREAMS COME TRUE

Living



Venature colorate

COLOURED GRAINS

Tornare bambini, a volte, può ridare colore alla nostra vita. Le porte della collezione Living prendono forma dando ascolto al fanciullo che c'è in noi. Vivi a colori e dai libero spazio alla fantasia, come quando disegnavi, piccino, nella tua cameretta. Geometrie, linee e curve vengono incise in un mix di originalità, per modelli tutti da scoprire. Originali e unici. Come i tuoi sogni migliori.

SOMETIMES, BEING A KID CAN BRING BACK COLOR TO OUR LIVES. THE DOORS OF THE LIVING COLLECTION TAKE SHAPE BY LISTENING TO THE CHILD IN US. LIVE IN COLOR AND GIVE FREE SPACE TO THE IMAGINATION, AS WHEN YOU WERE DRAWING, LITTLE BOY, IN YOUR ROOM. GEOMETRIES, LINES AND CURVES ARE ENGRAVED IN A MIX OF ORIGINALITY, FOR MODELS, ALL TO BE DISCOVERED. ORIGINAL AND UNIQUE, LIKE YOUR BEST DREAMS.

LV00

FINITURA · FINISH *Laccato Living Tortora*
TELAIO · FRAME *LT*
MANIGLIA · HANDLE *Sochi*

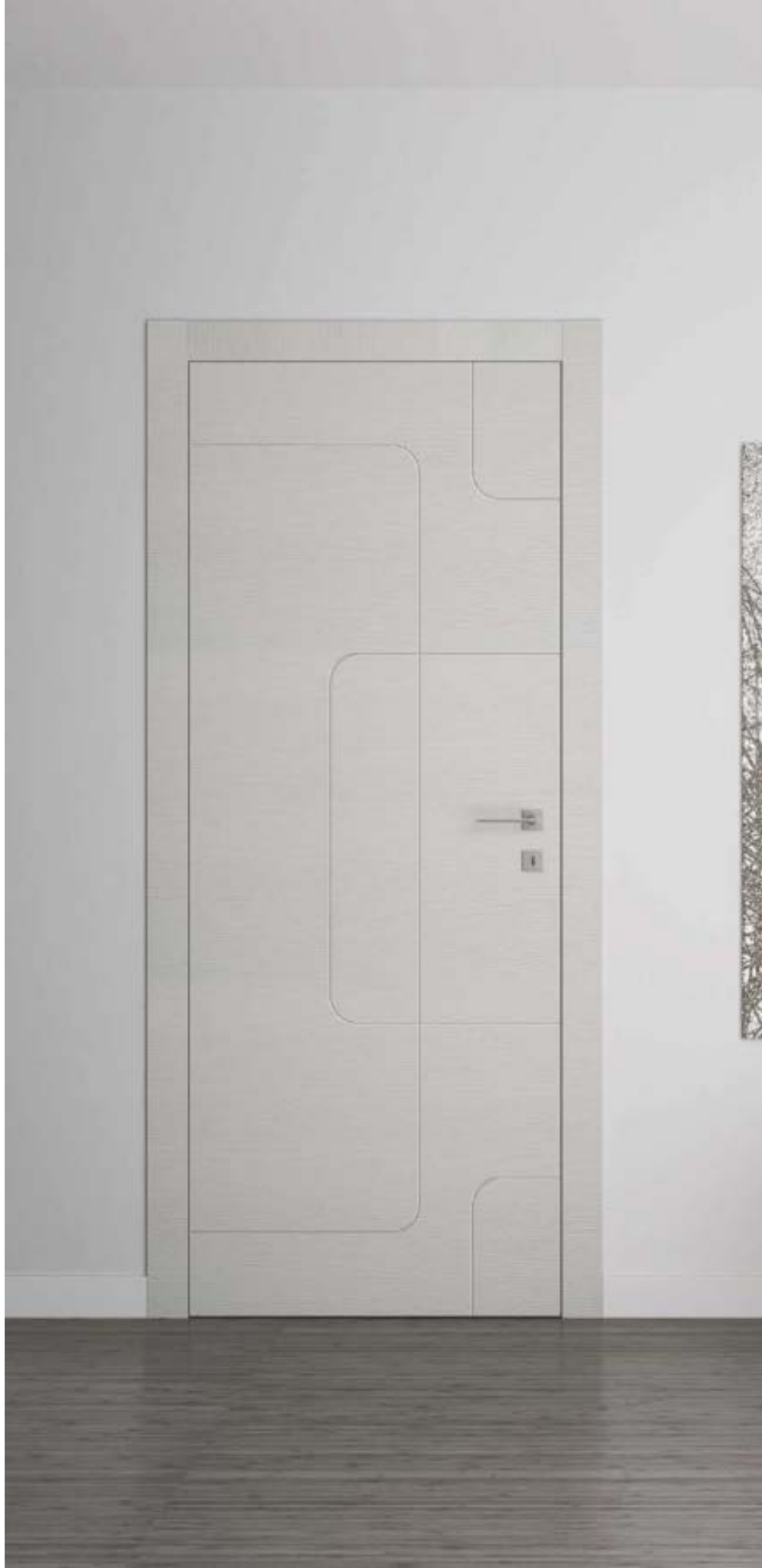

LV01

FINITURA · FINISH
Laccato Living Grigio

TELAIO · FRAME
LS

MANIGLIA · HANDLE
Sochi

H PORTA · H DOOR
210 cm



LV01

FINITURA · FINISH *Laccato Living Bianco Poro*
TELAIO · FRAME *LS*
MANIGLIA · HANDLE *Flux*





LV02

FINITURA · FINISH
Laccato Living Bianco Poro

TELAIO · FRAME
D1

MANIGLIA · HANDLE
Bordeaux

H PORTA · H DOOR
210 cm



LVF

FINITURA · FINISH *Laccato Living Tortora*
 TELAIO · FRAME *LS*
 MANIGLIA · HANDLE *Flux*
 VETRO · GLASS *C17-C*



LV03

FINITURA · FINISH
Laccato Living Tortora
 TELAIO · FRAME
*Scorrevoli interno
 muro con telaio*
 MANIGLIA · HANDLE
KM-MQ
 H PORTA · H DOOR
210 cm

LV04

FINITURA · FINISH
Laccato Living Ghiaccio

TELAIO · FRAME
*Scorrevole esterno muro
senza telaio*

MANIGLIA · HANDLE
KM-MT





LV05

FINITURA · FINISH
Laccato Living Tortora

TELAIO · FRAME
D5

MANIGLIA · HANDLE
Flux

H PORTA · H DOOR
210 cm



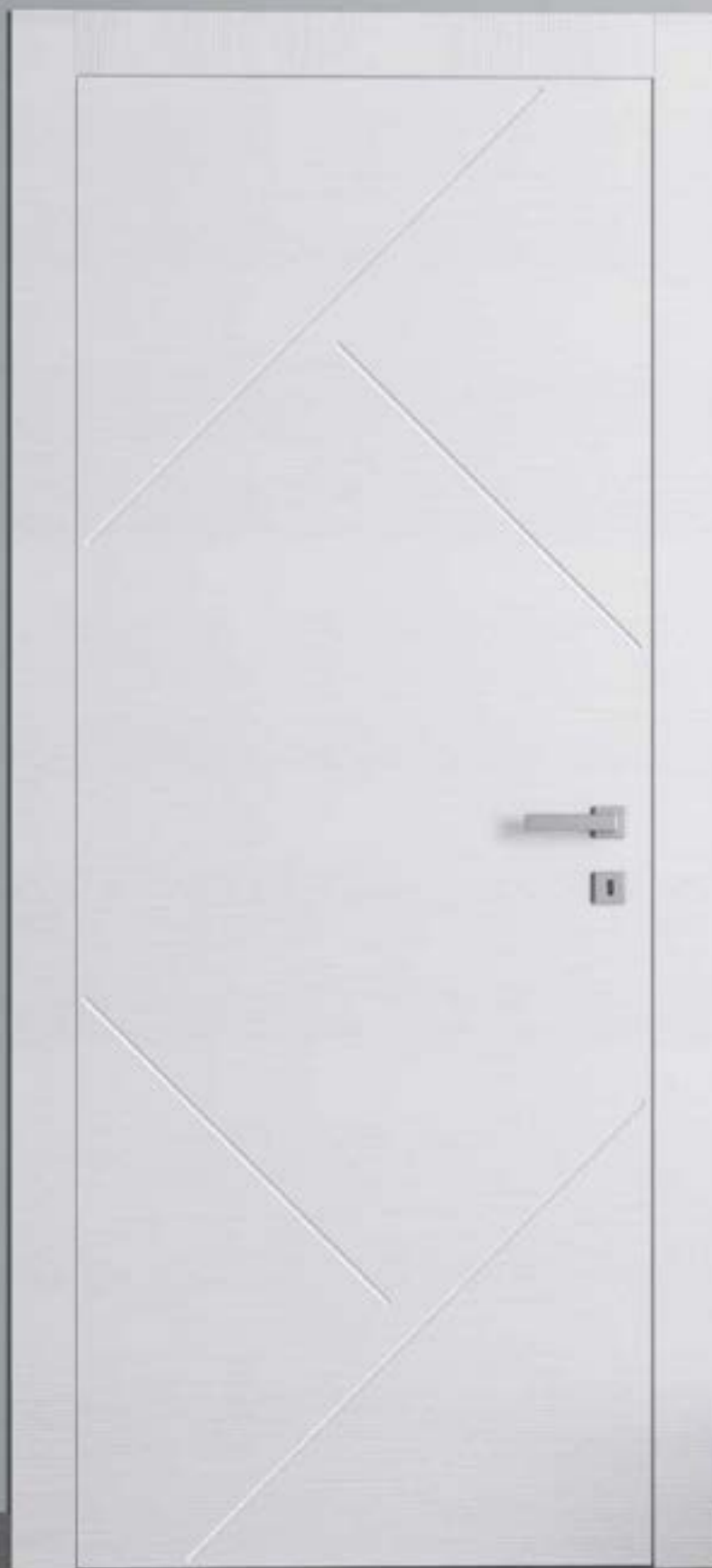

LV06

FINITURA · FINISH
Laccato Living Ghiaccio

TELAIO · FRAME
LS

MANIGLIA · HANDLE
Bordeaux

H PORTA · H DOOR
210 cm





LV07

FINITURA · FINISH
Laccato Living Acquamarina

TELAIO · FRAME
RS

MANIGLIA · HANDLE
Bordeaux

H PORTA · H DOOR
210 cm



LV00



LV01



LV02



LV03



LVF



LVF/C17-A



LVF/C17-B



LVF/C17-C



Porta cieca piana tamburata, cieca liscia o pantografata con incisioni che richiamano vari disegni geometrici. Versioni a battente, scorrevole, pieghevole simmetrica (DUO) o pieghevole asimmetrica 1/3-2/3 (PIEGO). L'anta in tamburato costituito da un telaio perimetrale esterno in massello di abete di circa mm 37x36, essiccato, epurato da nodi e canastro, giuntato a pettine, riempitivo in struttura alveolare trattata antitarlo e antimuffa, rivestimento in pannelli di fibra di legno a media densità di mm 4. Facciate rivestite con un decorativo a venatura orizzontale e laccate a poro aperto con finiture all'acqua. Porta finestrata intelaiata con montanti e traverse in listellare rivestiti e laccati come per le ante cieche. Il vetro da 6 mm è trattenuto nella fresata degli elementi dell'anta da una particolare guarnizione coestrusa in materiale plastico. Il vetro può essere sostituito previa rimozione della traversa superiore. Ferramenta: tre cerniere a scomparsa regolabili su 3 assi, serratura patent piccola (solo scrocco) frontale 18 mm ingresso 50 mm disponibili nelle finiture cromato opaco, cromato lucido e ottone lucido, o serratura magnetica nelle finiture cromo satinato, cromo lucido o bianca. Spessore totale anta 44 mm.

FLAT DOOR OR PANTOGRAPHED WITH ENGRAVINGS THAT RECALL VARIOUS GEOMETRIC DESIGNS. SWING, SLIDING, SYMMETRICAL FOLDING (DUO) OR ASYMMETRICAL FOLDING 1/3-2/3 (FOLD) VERSIONS. THE VENEERED DOOR STRUCTURE CONSISTS OF AN EXTERNAL PERIMETER FRAME IN SOLID FIR OF ABOUT 37X36 MM, DRIED, PURIFIED FROM KNOTS AND CANES, FINGER-JOINED, FILLER IN HONEYCOMB STRUCTURE TREATED ANTI-MILDEW AND ANTI-MILDEW, COVERING IN PANELS OF MEDIUM DENSITY WOOD FIBER OF 4 MM. SURFACES COVERED WITH A DECORATIVE HORIZONTAL VEIN WOOD AND LACQUERED WATER-BASED WITH OPEN PORE. GLASS DOOR IS MADE OF UPRIGHTS AND CROSSPIECES IN BLOCKBOARD COVERED AND LACQUERED AS FOR FLAT DOORS. THE 6 MM GLASS IS HELD IN THE MILLED DOOR ELEMENTS BY A SPECIAL CO-EXTRUDED GASKET IN PLASTIC MATERIAL. THE GLASS CAN BE REPLACED AFTER REMOVING THE UPPER CROSSPIECE. HARDWARE: THREE NOT VISIBLE HINGES ADJUSTABLE ON 3 AXES, SMALL PATENT LOCK (ONLY LATCH) FRONT 18 MM AVAILABLE IN MATT CHROME, POLISHED CHROME AND POLISHED BRASS FINISHES, OR MAGNETIC LOCK IN SATIN CHROME, POLISHED CHROME OR WHITE FINISHES. SWING THICKNESS 44 MM.

LV04



LV05



LV06



LV07



LVF/C17-D



LVF/C17-E



LVF/C17-R



LVF/C17-S



Laccato Living

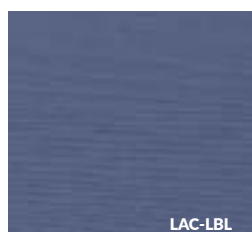

Finiture riproducibili in qualunque tinta RAL
 REPRODUCIBLE FINISHES IN ANY RAL COLOR



 SOLOLEGNO



LOCATION: MONVISO DA PIAN MUNÈ - PAESANA (CN)

S T I L I D E A

*Emozioni
ad alta quota*

HIGH ALTITUDE EMOTIONS

Stilidea



Sfumature artistiche

ARTISTIC SHADES

All'orizzonte lo skyline prodotto da un paesaggio naturale stupisce e conquista con le sue infinite variazioni e sfumature. E come in un'opera d'arte il pittore traccia su tela le sensazioni catturate dal suo sguardo, così le porte laccate della collezione Stilidea si presentano con ante dal design moderno e accattivante, su cui si esaltano disegni e motivi ora più semplici, ora più ricercati con un unico obiettivo: emozionare con la bellezza.

ON THE HORIZON, THE SKYLINE PRODUCED BY A NATURAL LANDSCAPE AMAZES AND CONQUERS WITH ITS INFINITE VARIATIONS AND NUANCES. AND JUST AS IN A WORK OF ART THE PAINTER TRACES THE SENSATIONS CAPTURED BY HIS GAZE ON CANVAS, SO THE LACQUERED DOORS OF THE STILIDEA COLLECTION ARE PRESENTED WITH DOORS OF MODERN AND CAPTIVATING DESIGN, ON WHICH DRAWINGS AND MOTIFS ARE EXALTED, SOMETIMES SIMPLER, SOMETIMES MORE SOUGHT-AFTER, WITH A SINGLE OBJECTIVE: TO EXCITE WITH BEAUTY.



F135

FINITURA · FINISH *Laccato Bianco AIP*
TELAIO · FRAME *TS*
MANIGLIA · HANDLE *Calais*



F145

FINITURA · FINISH *Laccato Acquamarina*
TELAIO · FRAME *TT*
MANIGLIA · HANDLE *Sochi*



F135

FINITURA · FINISH
Laccato Grigio

TELAIO · FRAME
RS

MANIGLIA · HANDLE
Bordeaux

H PORTA · H DOOR
240 cm





F145

FINITURA · FINISH
Laccato Ghiaccio

APERTURA · OPENING
Scorrevole esterno muro senza telaio

MANIGLIA · HANDLE
Vaschetta KM-MT

H PORTA · H DOOR
240 cm

S T I L I D E A



F151

FINITURA · FINISH
Laccato Acquamarina

TELAIO · FRAME
TN

MANIGLIA · HANDLE
Helsinki

H PORTA · H DOOR
210 cm





F149

FINITURA · FINISH *Laccato Tortora*
 TELAIO · FRAME *TN*
 MANIGLIA · HANDLE *Phoenix*



F151

FINITURA · FINISH *Laccato Candy*
 TELAIO · FRAME *TN*
 MANIGLIA · HANDLE *Phoenix*



F152

FINITURA · FINISH
Laccato Bianco AIP
 APERTURA · OPENING
Scorrevole esterno muro
 mod. *LINEARE*
 MANIGLIA · HANDLE
Vaschetta KM-MT
 H PORTA · H DOOR
 210 cm





F160

FINITURA · FINISH
Laccato Ghiaccio

TELAIO · FRAME

TT

MANIGLIA · HANDLE
Phoenix

H PORTA · H DOOR
210 cm



S T I L I D E A

F162

FINITURA · FINISH *Laccato Acquamarina*

TELAIO · FRAME *TN*

MANIGLIA · HANDLE *Leeds*



S T I L I D E A

F167

FINITURA · FINISH *Laccato Grigio*
TELAIO · FRAME *TN*
MANIGLIA · HANDLE *Phoenix*



LOCATION: POLLENZO - BRA (CN)

 SOLOLEGNO



F164

FINITURA · FINISH *Laccato Grigio*
TELAIO · FRAME *TN*
MANIGLIA · HANDLE *Phoenix*



F164

FINITURA · FINISH *Laccato Bianco AIP*
TELAIO · FRAME *TN*
MANIGLIA · HANDLE *Phoenix*



F165

FINITURA · FINISH *Laccato Ghiaccio*
TELAIO · FRAME *TT*
MANIGLIA · HANDLE *Calais*



F166

FINITURA · FINISH *Laccato Cioccolato*
TELAIO · FRAME *TS*
MANIGLIA · HANDLE *Calais*



F167

FINITURA · FINISH
Laccato Acquamarina

TELAIO · FRAME
RS

MANIGLIA · HANDLE
Helsinki

H PORTA · H DOOR
240 cm





F170

FINITURA · FINISH *Laccato Grigio*
 TELAIO · FRAME *TS*
 MANIGLIA · HANDLE *Calais*



F169

FINITURA · FINISH *Laccato Bianco AIP*
 TELAIO · FRAME *TN*
 MANIGLIA · HANDLE *Phoenix*



F168

FINITURA · FINISH
Laccato Ghiaccio
 APERTURA · OPENING
Doppio scorrevole interno muro senza telaio
 MANIGLIA · HANDLE
Maniglione MAN-TC
 H PORTA · H DOOR
 250 cm

Porta cieca piana tamburata, a battente, scorrevole interno o esterno muro, pieghevole simmetrica (DUO) o pieghevole asimmetrica 1/3-2/3 (PIEGO). Anta tamburata con telaio perimetrale esterno in massello di abete di circa mm 37x32, essiccato, epurato da nodi e canastro, giuntato a pettine, riempitivo in struttura alveolare trattata antitarlo e antimuffa, rivestimento in pannelli di fibra di legno a media densità di 6 mm di spessore. Fresature di medie dimensioni sulle facciate con vari disegni geometrici.

Ferramenta: tre cerniere a scomparsa regolabili su 3 assi o le classiche anuba, serratura patent piccola (solo scrocco) frontale 18 mm ingresso 50 mm disponibili nelle finiture cromato opaco, cromato lucido e ottone lucido, o serratura magnetica nelle finiture cromo satinato, cromo lucido o bianca. Spessore totale anta 44 mm.

FLAT DOOR, SWING, SLIDING INSIDE OR OUTSIDE WALL, SYMMETRICAL FOLDING (DUO) OR ASYMMETRICAL FOLDING 1/3-2/3 (FOLD). VENEERED DOOR STRUCTURE WITH EXTERNAL PERIMETER FRAME IN SOLID FIR WOOD OF ABOUT 37X32 MM, DRIED, KNOT AND CANON STRIPPED, FINGER-JOINED, FILLER IN HONEYCOMB STRUCTURE TREATED AS ANTI-MILDEW AND ANTI-MILDEW, COVERING IN MEDIUM DENSITY WOOD FIBRE PANELS OF 6 MM THICKNESS. MEDIUM-SIZED MILLING ON THE SURFACE WITH VARIOUS GEOMETRIC DESIGNS OR WITH SMALL ALUMINIUM BARS. HARDWARE: THREE NOT VISIBLE HINGES ADJUSTABLE ON 3 AXES OR THE CLASSIC ANUBA, SMALL PATENT LOCK (ONLY LATCH) FRONTAL 18 MM AVAILABLE IN MATT CHROME, POLISHED CHROME AND POLISHED BRASS FINISHES, OR MAGNETIC LOCK IN SATIN CHROME, POLISHED CHROME OR WHITE FINISHES. SWING THICKNESS 44 MM.

F135



F160



F167



Laccato **opaco** 



Laccato **effetto seta**

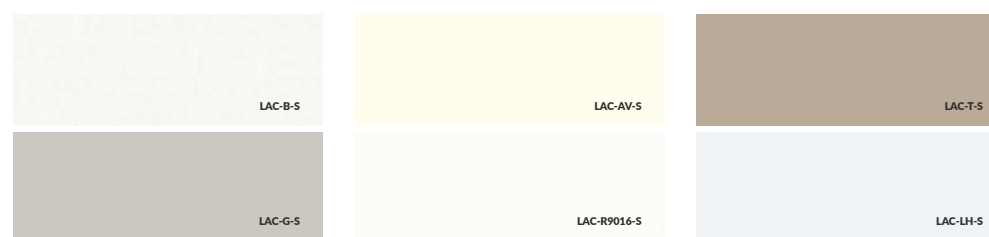

F145



F149



F151



F152



F162



F164



F165



F166



F168



F169



F170



The logo for SOLOLEGNO, featuring a stylized white leaf icon to the left of the brand name in a white serif font.

SOLOLEGNO



LOCATION: BRA (CN)

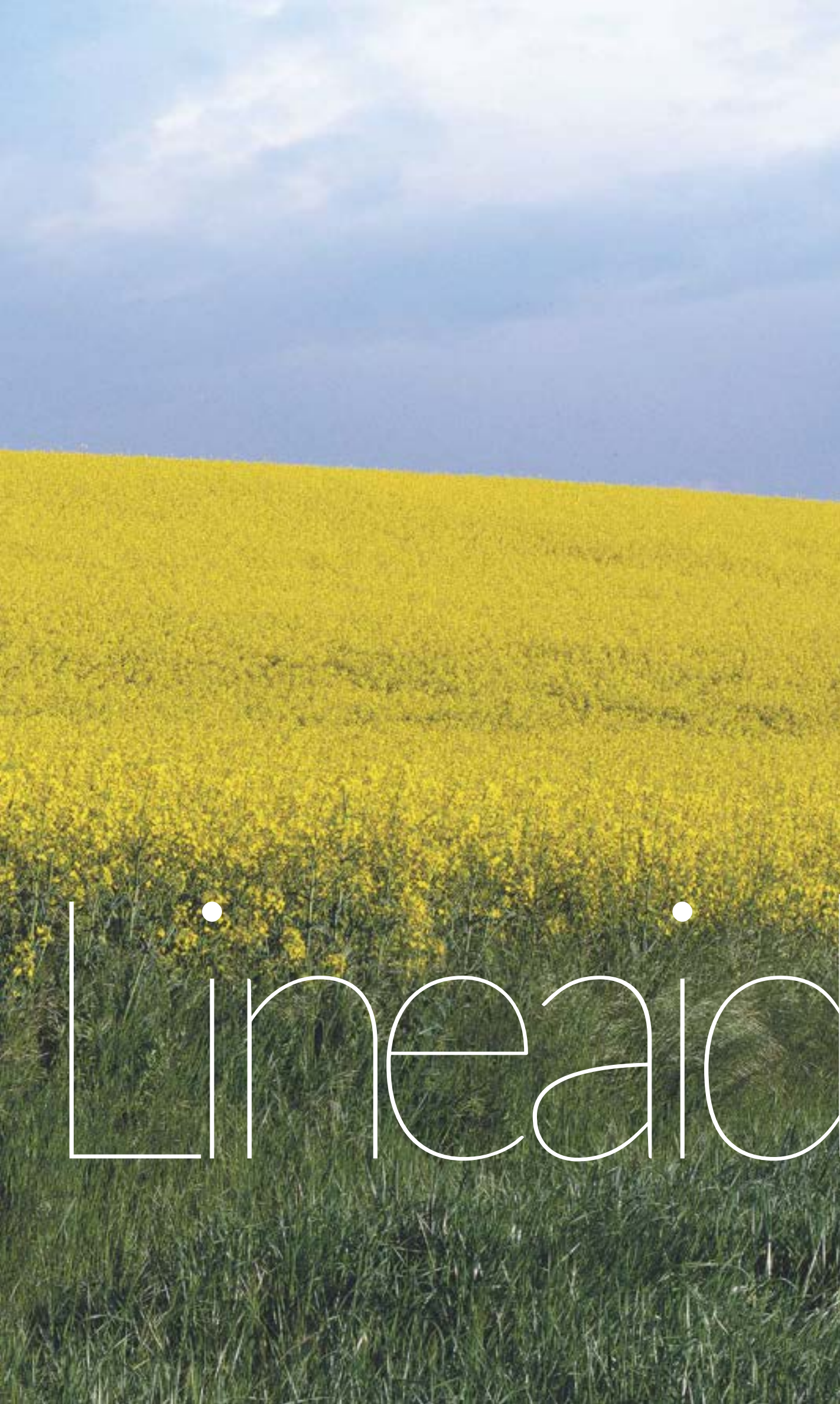

*Tracce a
tutto campo*

ALL-ROUND TRACKS

lineaidea

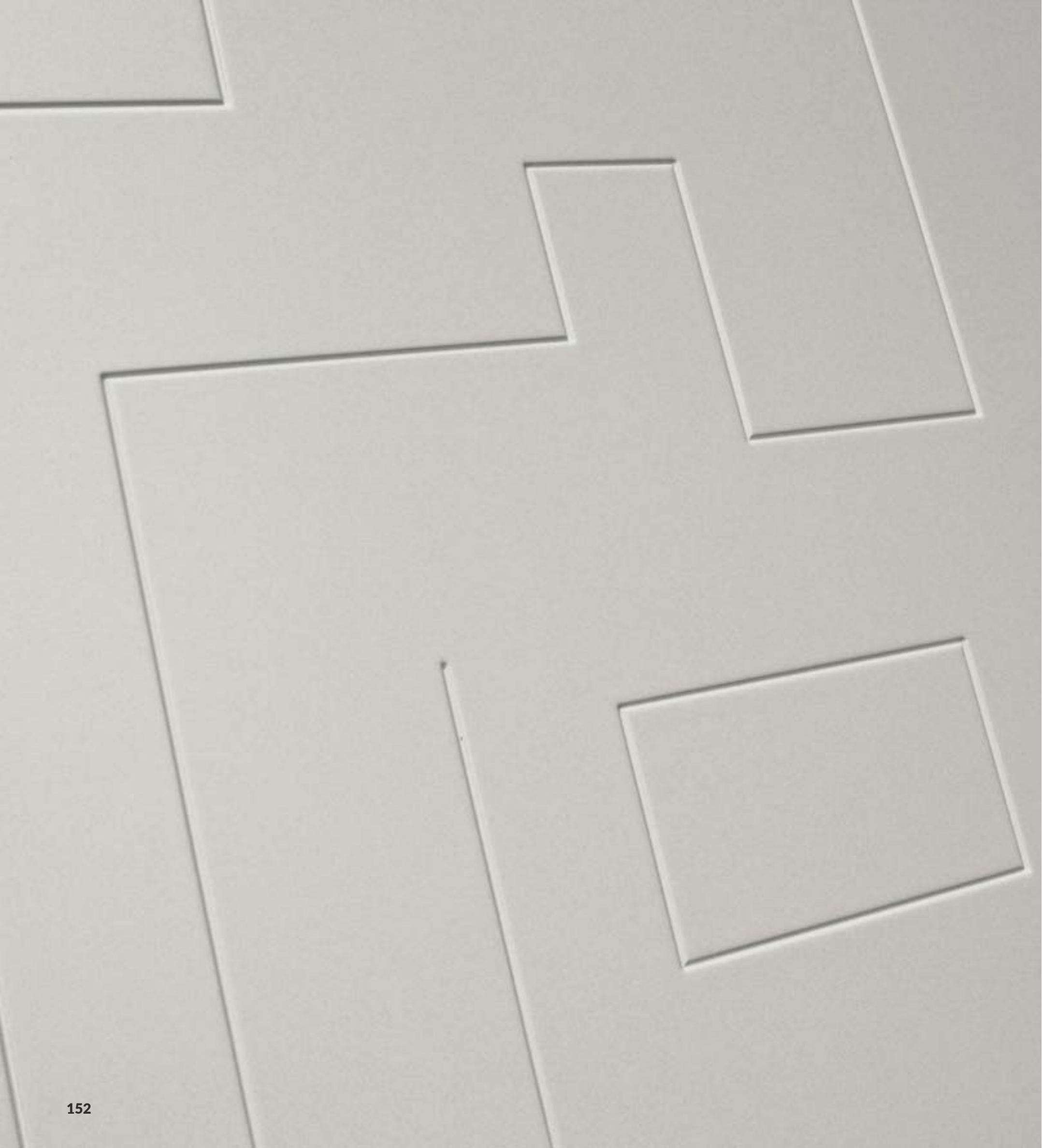

Geometrie **preziose**

PRECIOUS GEOMETRY

Ogni traccia che lasciamo parla di noi. Sulle porte laccate della collezione Lineaidea ne abbiamo un fulvido esempio. Ante semplici, ma mai banali, sono segnate da incisioni nette e geometrie variabili a seconda del punto di osservazione. Il tutto è arricchito da filetti in alluminio, impreziositi da linee di swarovski brillanti per catturare ogni riflesso e valorizzare gli spazi da vivere. Dettagli capaci di fare la differenza.

EVERY TRACE WE LEAVE SPEAKS OF US. ON THE LACQUERED DOORS OF THE LINEAIDEA COLLECTION WE HAVE A SHINING EXAMPLE. SIMPLE SWINGS, BUT NEVER BANAL, ARE MARKED BY CLEAN ENGRAVINGS AND VARIABLE GEOMETRIES DEPENDING ON THE POINT OF VIEW. EVERYTHING IS ENRICHED BY ALUMINIUM THREADS, EMBELLISHED WITH LINES OF BRILLIANT SWAROVSKI TO CAPTURE EVERY REFLECTIONS.. DETAILS CAPABLE OF MAKING A DIFFERENCE.

FF21

FINITURA · FINISH
Laccato Bianco AIP

TELAIO · FRAME
RS

MANIGLIA · HANDLE
Flux

H PORTA · H DOOR
270 cm



FF23

FINITURA · FINISH *Laccato Grigio*

TELAIO · FRAME *TT*

MANIGLIA · HANDLE *Flux*



FF20

FINITURA · FINISH *Laccato Acquamarina*

TELAIO · FRAME *TN*

MANIGLIA · HANDLE *Flux*



FF22

FINITURA · FINISH
Laccato Ghiaccio

TELAIO · FRAME
TN

MANIGLIA · HANDLE
Flux

H PORTA · H DOOR
250 cm





FF25

FINITURA · FINISH
Laccato Candy

TELAIO · FRAME
RS

MANIGLIA · HANDLE
Helsinki

H PORTA · H DOOR
270 cm



FF25

FINITURA · FINISH *Laccato Ghiaccio*
 TELAIO · FRAME *TN*
 MANIGLIA · HANDLE *Helsinki*



FF27

FINITURA · FINISH *Laccato Acquamarina*
 TELAIO · FRAME *TT*
 MANIGLIA · HANDLE *Sochi*



FF24

FINITURA · FINISH
Laccato Grigio
 TELAIO · FRAME
TS
 MANIGLIA · HANDLE
Sochi
 H PORTA · H DOOR
 210 cm



FF28

FINITURA · FINISH
Laccato Ghiaccio

APERTURA · OPENING
*Scorrevole esterno muro senza telaio
mod. Lineare*

MANIGLIA · HANDLE
KM-MT

H PORTA · H DOOR
270 cm



FF28

FINITURA · FINISH *Laccato Bianco AIP*
TELAIO · FRAME *TN*
MANIGLIA · HANDLE *Leeds*



FF29

FINITURA · FINISH *Laccato Acquamarina*
TELAIO · FRAME *TN*
MANIGLIA · HANDLE *Bordeaux*



FF30

FINITURA · FINISH *Laccato Candy*
TELAIO · FRAME *TN*
MANIGLIA · HANDLE *Leeds*



FS3

FINITURA · FINISH *Laccato Tortora*
TELAIO · FRAME *TT*
MANIGLIA · HANDLE *Sochi*
INSERTO · INSERT *Filetto in alluminio*



FS3

FINITURA · FINISH
Laccato Ghiaccio
TELAIO · FRAME
TN
MANIGLIA · HANDLE
Helsinki
H PORTA · H DOOR
210 cm
INSERTO · INSERT
Filetto in alluminio



FS5

FINITURA · FINISH *Laccato Candy*
 TELAIO · FRAME *TN*
 MANIGLIA · HANDLE *Leeds*
 INSERTO · INSERT *Filetto in alluminio*



FS4

FINITURA · FINISH *Laccato Grigio*
 TELAIO · FRAME *TS*
 MANIGLIA · HANDLE *Calais*
 INSERTO · INSERT *Filetto in alluminio*



FS7

FINITURA · FINISH
Laccato Acquamarina
 APERTURA · OPENING
*Doppia scorrevole esterno muro
 senza telaio*
 MANIGLIA · HANDLE
MAN-Q20-L
 H PORTA · H DOOR
250 cm
 INSERTO · INSERT
Filetto in alluminio



FFA

FINITURA · FINISH *Laccato Ghiaccio*

APERTURA · OPENING *Scorrevole interno muro senza telaio*

MANIGLIA · HANDLE *Vaschetta tonda KM-MT*



FFF

FINITURA · FINISH *Laccato Candy*

TELAIO · FRAME *TN*

MANIGLIA · HANDLE *Leeds*



FF7

FINITURA · FINISH *Laccato Acquamarina*

TELAIO · FRAME *TT*

MANIGLIA · HANDLE *Bordeaux*



FF4

FINITURA · FINISH *Laccato Grigio*

TELAIO · FRAME *TN*

MANIGLIA · HANDLE *Phoenix*



FFC

FINITURA · FINISH *Laccato Ghiaccio*

TELAIO · FRAME *TS*

MANIGLIA · HANDLE *Calais*



FF2

FINITURA · FINISH
Laccato Bianco AIP

TELAIO · FRAME
Traslo

MANIGLIA · HANDLE
Flux

H PORTA · H DOOR
210 cm

FF2

FINITURA · FINISH *Laccato Bianco AIP*
TELAIO · FRAME *TT*
MANIGLIA · HANDLE *Flux*
H PORTA · H DOOR *210 cm*

F129

FINITURA · FINISH
tinteggiabile come parete

TELAIO · FRAME
RS

MANIGLIA · HANDLE
Sochi

H PORTA · H DOOR
270 cm



F129

FINITURA · FINISH
Laccato Aquamarina

TELAIO · FRAME
TN

MANIGLIA · HANDLE
Phoenix



F129

FINITURA · FINISH
Laccato Ghiaccio

TELAIO · FRAME
TN

MANIGLIA · HANDLE
Phoenix



F129

FINITURA · FINISH
Laccato Candy

TELAIO · FRAME
TN

MANIGLIA · HANDLE
Phoenix



Porta cieca piana tamburata, a battente, scorrevole interno o esterno muro, pieghevole simmetrica (DUO) o pieghevole asimmetrica 1/3-2/3 (PIEGO). Anta tamburata con telaio perimetrale esterno in massello di abete di circa mm 37x36, essiccato, epurato da nodi e canastro, giuntato a pettine, riempitivo in struttura alveolare trattata antitarlo e antimuffa, rivestimento in pannelli di fibra di legno a media densità di 4 o 6 mm di spessore. Piccole fresature incisioni sulle facciate con vari disegni geometrici o con filetti in alluminio.

Fresature di medie dimensioni sulle facciate con vari disegni geometrici o con filetti in alluminio. Ferramenta: tre cerniere a scomparsa regolabili su 3 assi o le classiche anuba, serratura patent piccola (solo scrocco) frontale 18 mm ingresso 50 mm disponibili nelle finiture cromato opaco, cromato lucido e ottone lucido, o serratura magnetica nelle finiture cromo satinato, cromo lucido o bianca. Spessore totale anta 44 mm.

FLAT DOOR, SWING, SLIDING INSIDE OR OUTSIDE WALL, SYMMETRICAL FOLDING (DUO) OR ASYMMETRICAL FOLDING 1/3-2/3 (FOLD). VENEERED DOOR STRUCTURE WITH EXTERNAL PERIMETER FRAME IN SOLID FIR WOOD OF ABOUT 37X36 MM, DRIED, KNOT AND CANON STRIPPED, FINGER-JOINED, FILLER IN HONEYCOMB STRUCTURE TREATED AS ANTI-MILDEW AND ANTI-MILDEW, COVERING IN MEDIUM DENSITY WOOD FIBRE PANELS OF 6 MM THICKNESS. MEDIUM-SIZED MILLING ON THE SURFACE WITH VARIOUS GEOMETRIC DESIGNS OR WITH SMALL ALUMINIUM BARS. HARDWARE: THREE NOT VISIBLE HINGES ADJUSTABLE ON 3 AXES OR THE CLASSIC ANUBA, SMALL PATENT LOCK (ONLY LATCH) FRONTAL 18 MM AVAILABLE IN MATT CHROME, POLISHED CHROME AND POLISHED BRASS FINISHES, OR MAGNETIC LOCK IN SATIN CHROME, POLISHED CHROME OR WHITE FINISHES. SWING THICKNESS 44 MM.

Laccato **opaco**

LAC-B-R	LAC-AV-R	LAC-CC-R
LAC-G-R	LAC-T-R	LAC-VA-R
LAC-LH-R	LAC-RA-R	LAC-BL-R
LAC-RS-9010	LAC-RS-9003	LAC-RS-9016

Laccato **effetto seta**

LAC-B-S	LAC-AV-S	LAC-T-S
LAC-G-S	LAC-R9016-S	LAC-LH-S

F129



FF2



FF23



FF24



FFA



FFC



FF4



FF7



FF20



FF21



FF22



FF25



FF30



FF27



FF28



FF29



FFF



FS3



FS4



FS5



FS7



The logo for SOLOLEGNO, featuring a stylized leaf icon to the left of the brand name in a serif font.

SOLOLEGNO

LOCATION: POLLENZO - BRA (CN)

F I A B I D E A

*Leggende
dal finale
sempre nuovo*

LEGENDS FROM THE
ENDING ALWAYS NEW

Fiabidea



La tradizione **si fa in quattro**

TRADITION IS MADE IN FOUR

Simili, ma differenti. Sono le porte laccate della collezione Fiabidea, ever green di Sololegno, che abbinano quattro diversi profili a disegni che, pur nella loro somiglianza, sono in grado di riservare sensazioni sempre nuove in ogni tipo di ambiente. Quindi un consiglio: non farsi ingannare dalla quiete apparente, ma lasciarsi trasportare dalla luce che fa capolino dalle possibili porzioni vetrate per seguirla fino a destinazione. Lì troverai il finale che non ti aspetti.

SIMILAR, BUT DIFFERENT. THESE ARE THE LACQUERED DOORS OF THE FIABIDEA COLLECTION, EVER GREEN BY SOLOLEGNO, WHICH COMBINE FOUR DIFFERENT DESIGNS THAT, DESPITE THEIR SIMILARITY, ARE ABLE TO RESERVE NEW SENSATIONS IN EVERY TYPE OF ENVIRONMENT. SO A TIP: DON'T BE FOOLED BY THE APPARENT QUIETNESS, BUT LET YOURSELF BE CARRIED AWAY BY THE LIGHT THAT RISE FROM THE POSSIBLE GLASS PORTIONS. THERE YOU'LL FIND THE ENDING YOU DON'T EXPECT.

F113



Design
Classic
DESIGN CLASSIC



FB13



Design
Style
DESIGN STYLE



FC13



Design
Minimal
DESIGN MINIMAL



FD13



Design
Elegance
DESIGN ELEGANCE



F113-F

FINITURA · FINISH
Laccato Ghiaccio

TELAIO · FRAME
T2

MANIGLIA · HANDLE
Sochi

H PORTA · H DOOR
210 cm

VETRO · GLASS
Satinato Extrachiaro

F113

FINITURA · FINISH
Laccato Ghiaccio

TELAIO · FRAME
T2

MANIGLIA · HANDLE
Sochi

H PORTA · H DOOR
210 cm

F113

FINITURA · FINISH *Laccato Bianco AIP*
TELAIO · FRAME **T1**
MANIGLIA · HANDLE *Glasgow*



F126

FINITURA · FINISH *Laccato Tortora*
TELAIO · FRAME **T1**
MANIGLIA · HANDLE *Glasgow*



F126

FINITURA · FINISH
Laccato Acquamarina
TELAIO · FRAME
T2
MANIGLIA · HANDLE
Glasgow
H PORTA · H DOOR
210 cm





FB12

FINITURA · FINISH
Laccato Bianco AIP

TELAIO · FRAME
T1

MANIGLIA · HANDLE
Glasgow

H PORTA · H DOOR
210 cm

FB56

FINITURA · FINISH *Laccato Avorio*

TELAIO · FRAME **T1**

MANIGLIA · HANDLE *Glasgow*



FB12-f

FINITURA · FINISH *Laccato Grigio*

TELAIO · FRAME **T1**

MANIGLIA · HANDLE *Glasgow*



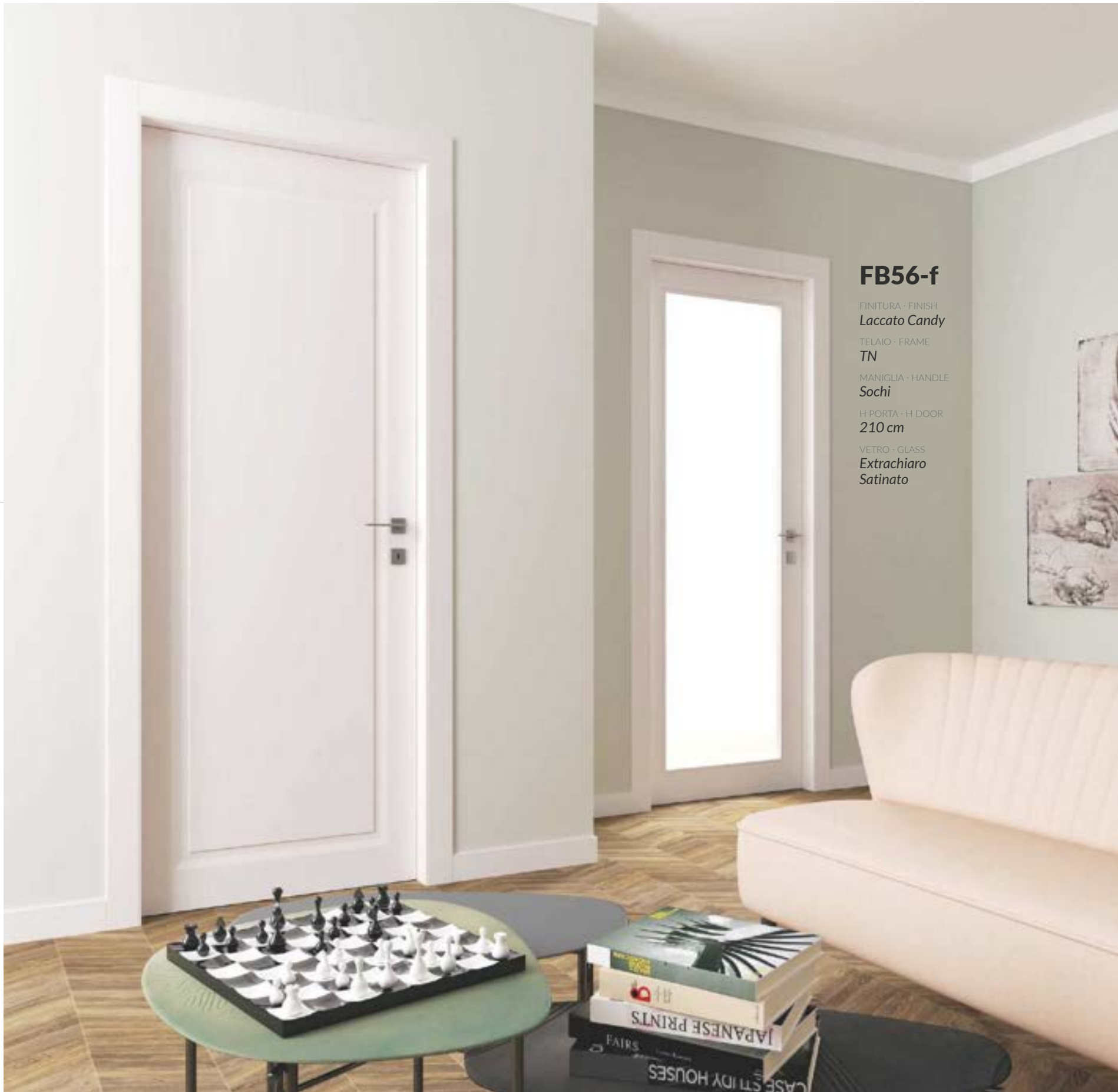

FB56-f

FINITURA · FINISH
Laccato Candy

TELAIO · FRAME
TN

MANIGLIA · HANDLE
Sochi

H PORTA · H DOOR
210 cm

VETRO · GLASS
*Extrachiaro
Satinato*

FB56

FINITURA · FINISH *Laccato Candy*
TELAIO · FRAME **TN**
MANIGLIA · HANDLE *Sochi*

F I A B I D E A
Design **Minimal**

FC13 

FINITURA · FINISH *Laccato RAL 7000*
TELAIO · FRAME *TN*
MANIGLIA · HANDLE *Phoenix*



FC13 

FINITURA · FINISH *Laccato RAL 6034*
TELAIO · FRAME *TN*
MANIGLIA · HANDLE *Phoenix*



 SOLOLEGNO

LOCATION: POLLENZO - BRA (CN)



FC54

FINITURA · FINISH
Laccato Bianco AIP

TELAIO · FRAME
TT

MANIGLIA · HANDLE
Flux

H PORTA · H DOOR
210 cm



FC54

FINITURA · FINISH *Laccato Ghiaccio*
TELAIO · FRAME *TT*
MANIGLIA · HANDLE *Calais*



FC58

FINITURA · FINISH *Laccato Bianco AIP*
TELAIO · FRAME *TN*
MANIGLIA · HANDLE *Leeds*



FC55

FINITURA · FINISH *Laccato Acquamarina*
TELAIO · FRAME *TN*
MANIGLIA · HANDLE *Glasgow*





FD56

FINITURA · FINISH
Laccato Grigio

TELAIO · FRAME
TS

MANIGLIA · HANDLE
Bordeaux

H PORTA · H DOOR
210 cm

FD59

FINITURA · FINISH
Laccato Bianco AIP

TELAIO · FRAME
TT

MANIGLIA · HANDLE
Flux

H PORTA · H DOOR
210 cm



F109



F112



F113



F117



F121



F109-F



F112-F



F113-F



F117-F



F121-F



F126



Porta cieca piana o finestrata tamburata, a battente, scorrevole interno o esterno muro, pieghevole simmetrica (DUO) o pieghevole asimmetrica 1/3-2/3 (PIEGO). Anta tamburata con telaio perimetrale esterno in massello di abete di circa mm 37x32, essiccato, epurato da nodi e canastro, giuntato a pettine, riempitivo in struttura alveolare trattata antitarlo e antimuffa, rivestimento in pannelli di fibra di legno a media densità di 6 mm di spessore. Quattro tipologie di fresature sulle facciate delle ante, da quelle più sagomate a quelle più lineari, con vari disegni geometrici. Ferramenta: tre cerniere a scomparsa regolabili su 3 assi o le classiche anuba, serratura patent piccola (solo scrocco) frontale 18 mm ingresso 50 mm disponibili nelle finiture cromato opaco, cromato lucido e ottone lucido, o serratura magnetica nelle finiture cromo satinato, cromo lucido o bianca. Spessore totale anta 44 mm.

FB12



FB13



FB54



FB55



FB56



FB12-F



FB13-F



FB54-F



FB55-F



FB56-F



FB12-C



Laccato **opaco** 



Laccato **effetto seta**

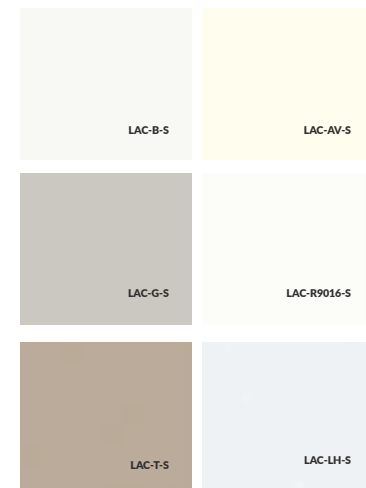

FC12



FC13



FC54



FC55



FC56



FC12-F



FC13-F



FC54-F



FC55-F



FC56-F



FC12-C



FC58



SWING DOOR (WITH GLASS WINDOW OR NOT), SLIDING INSIDE OR OUTSIDE WALL, SYMMETRICAL FOLDING (DUO) OR ASYMMETRICAL FOLDING 1/3-2/3 (FOLD). VENEERED DOOR STRUCTURE WITH EXTERNAL PERIMETER FRAME IN SOLID FIR WOOD OF ABOUT 37X32 MM, DRIED, KNOT AND CANON STRIPPED, FINGER-JOINED, FILLER IN HONEYCOMB STRUCTURE TREATED AS ANTI-MILDEW AND ANTI-MILDEW, COVERING IN MEDIUM DENSITY WOOD FIBRE PANELS OF 6 MM THICKNESS. FOUR TYPES OF MILLING ON THE FACADES OF THE DOORS, FROM THE MOST SHAPED TO THE MOST LINEAR, WITH VARIOUS GEOMETRIC DESIGNS. HARDWARE: THREE NOT VISIBLE HINGES ADJUSTABLE ON 3 AXES OR THE CLASSIC ANUBA, SMALL PATENT LOCK (ONLY LATCH) FRONTAL 18 MM, AVAILABLE IN MATT CHROME, POLISHED CHROME AND POLISHED BRASS FINISHES, OR MAGNETIC LOCK IN SATIN CHROME, POLISHED CHROME OR WHITE FINISHES. SWING THICKNESS 44 MM.



FD13



FD54



FD55



FD56



FD59



FD13-F



FD54-F



FD55-F



FD56-F



FD59-F



Laccato **opaco** 

LAC-B-R	LAC-AV-R	LAC-CC-R
LAC-G-R	LAC-T-R	LAC-VA-R
LAC-LH-R	LAC-RA-R	LAC-BL-R
LAC-RS-9010	LAC-RS-9003	LAC-RS-9016

Laccato **effetto seta**

LAC-B-S	LAC-AV-S
LAC-G-S	LAC-R9016-S
LAC-T-S	LAC-LH-S





SOLOLEGNO



LOCATION: CANTINA CASCINA ADELAIDE - BAROLO (CN)

I M A G I N E

*Profumo
di tradizione*

TRADITIONAL SCENT

Imagine



Morbide **sensazioni**

SOFT SENSATIONS

Il calore della famiglia, la sicurezza della tradizione. Trasmettono pace e armonia le porte in legno della collezione Imagine, che a componenti assemblate abbinano profili "morbidi", capaci di conferire ad ogni spazio sensazioni nuove ma legate indissolubilmente ad un passato che non smette di raccontarsi. Anche i coprifili si adeguano a questo incedere, in un'alternanza di linee stondate e tratti più regolari. Per ambienti accoglienti e familiari.

THE WARMTH OF FAMILY, THE SECURITY OF TRADITION. PEACE AND HARMONY ARE CONVEYED BY THE WOODEN DOORS OF IMAGINE COLLECTION, WHICH COMBINE ASSEMBLED COMPONENTS WITH "SOFT" PROFILES, CAPABLE OF GIVING AT EACH SPACE NEW SENSATIONS BUT INDISSOLUBLY LINKED TO A PAST THAT NEVER CEASES TO TELL ITSELF, IN AN ALTERNATION OF ROUNDED LINES AND MORE REGULAR LINES. FOR WELCOMING AND FAMILIAR ENVIRONMENTS.

I M A G I N E

MGN2

FINITURA · FINISH
Frassino Tinto Caffè

TELAIO · FRAME
T1

MANIGLIA · HANDLE
Bordeaux



MGN1-F

FINITURA · FINISH *Frassino Tinto Canaletto*
TELAIO · FRAME *T5*
MANIGLIA · HANDLE *Glasgow*
VETRO · GLASS *extrachiaro satinato*



MGN1

FINITURA · FINISH *Frassino Tinto Canaletto*
TELAIO · FRAME *T5*
MANIGLIA · HANDLE *Glasgow*

MGN2

FINITURA · FINISH
Laccato Bianco AIP

TELAIO · FRAME
T2

MANIGLIA · HANDLE
Bordeaux



MGN3

FINITURA · FINISH
Laccato Acquamarina

TELAIO · FRAME
T2

MANIGLIA · HANDLE
Helsinki

H PORTA · H DOOR
210 cm



MGN5

FINITURA · FINISH
Rovere Tinto Canaletto

TELAIO · FRAME
T5

MANIGLIA · HANDLE
Bordeaux



MGN5

FINITURA · FINISH
Laccato Ghiaccio

TELAIO · FRAME
T5

MANIGLIA · HANDLE
Glasgow

H PORTA · H DOOR
210 cm



MGN10

FINITURA · FINISH
Rovere Tinto Effetto Naturale

TELAIO · FRAME
T3

MANIGLIA · HANDLE
Glasgow

H PORTA · H DOOR
210 cm

MGN10-F

FINITURA · FINISH
Rovere Tinto Effetto Naturale

TELAIO · FRAME
T3

MANIGLIA · HANDLE
Glasgow

H PORTA · H DOOR
210 cm

VETRO · GLASS
Extrachiaro Satinato





MGN11

FINITURA · FINISH
Laccato Bianco AIP

TELAIO · FRAME
T1

MANIGLIA · HANDLE
Bordeaux



MGN11

FINITURA · FINISH
Frassino Tinto Quercia Dark

TELAIO · FRAME
T2

MANIGLIA · HANDLE
Bordeaux



MGN13

FINITURA · FINISH
Laccato Grigio

TELAIO · FRAME
T1

MANIGLIA · HANDLE
Bordeaux



MGN13

FINITURA · FINISH
Frassino Tinto Cognac

TELAIO · FRAME
T2

MANIGLIA · HANDLE
Bordeaux



MGN14

FINITURA · FINISH
Laccato Acquamarina

TELAIO · FRAME
T1

MANIGLIA · HANDLE
Helsinki

H PORTA · H DOOR
210 cm



Rovere **tinto** spazzolato

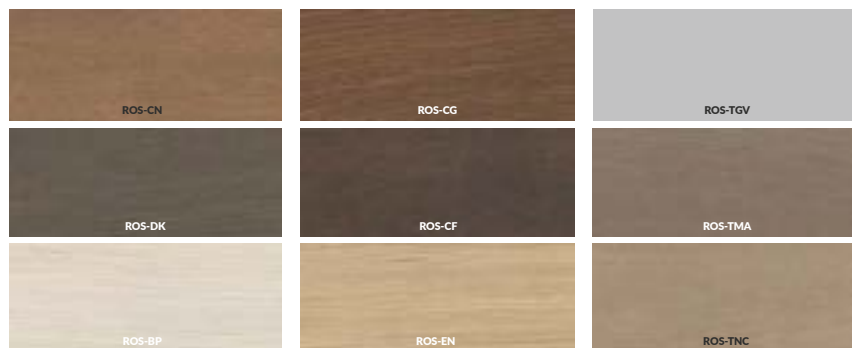

Rovere **laccato** spazzolato

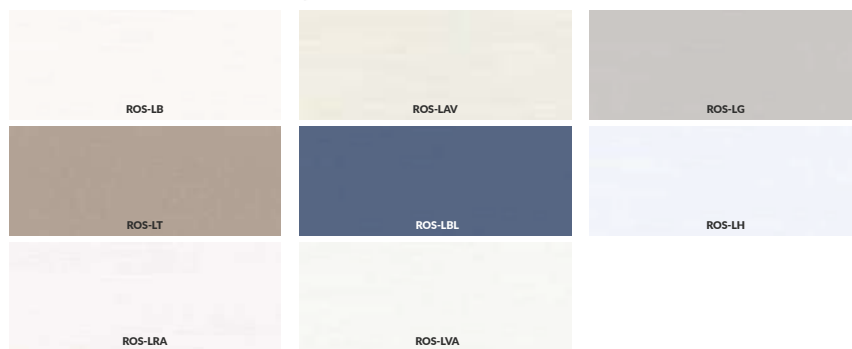

Frassino **tinto** spazzolato

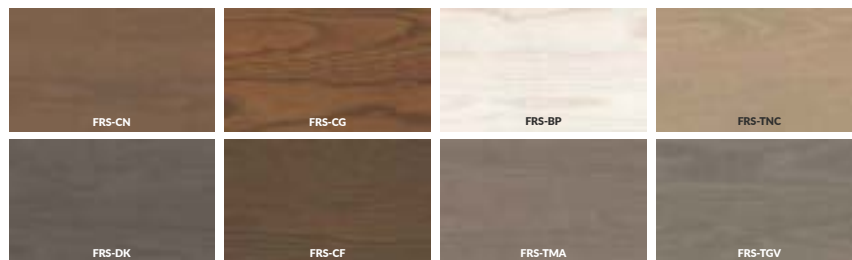

Frassino **laccato** spazzolato



Laccato **opaco**



Laccato **effetto seta**



Porta in stile intelaiata, a battente o scorrevole, con profili perimetrali e/o trasversali costituiti da una struttura in legno listellare di abete rivestiti in tranciato pregiato di Frassino, Rovere. Le versioni possono essere cieche o a vetrate. I pannellotti in numero diverso e forme a seconda dei modelli sono diamantati, costituiti da pannelli in fibra di legno di media densità (MDF) da 22 mm, impiallacciati con il medesimo legno tranciato dei profili perimetrali. Queste porte grazie all'unione dei vari profilati in legno con pannelli e/o vetri, possono dare origine a diversi disegni e varianti. L'assemblaggio avviene tramite spine di legno e incollaggio vinilico. Per le versioni finestrate o con vetro montato la traversa superiore è ancorata ai montanti tramite giunti meccanici. La parte sagomata dei montanti creano la sede per ospitare pannellotti e vetri. I vetri, da 5-6 mm, sono contornati da una speciale guarnizione coestrusa che funge da isolamento tra il profilo in legno ed il vetro stesso. Per tutte le altre versioni dove i vetri NON sono forniti dall'AIP S.r.l., il relativo montaggio del vetro è a cura del posatore che mette in opera il vetro con un idoneo sistema di fissaggio.

Le tinte, i patinati o le laccature a poro aperto sono finiture all'acqua.

Ferramenta: tre cerniere tipo anuba Ø 13 mm a gambo singolo con relativi cappucci copri-anuba, serratura patent piccola (solo scrocco) frontale 18 mm ingresso 50 mm disponibili nelle finiture cromato opaco, cromato lucido e ottone lucido, o serratura magnetica nelle finiture cromo satinato, cromo lucido o bianca. Spessore totale anta 44 mm.

FRAMED STYLE DOOR, SWING OR SLIDING, WITH PROFILES CONSISTING OF A STRUCTURE IN BLOCKBOARD VENEERED WITH ASH, AND OAK. THE VERSIONS CAN BE FLAT OR WINDOW VERSION. THE PANELS IN DIFFERENT NUMBERS AND SHAPES, DEPENDING ON THE MODEL, ARE DIAMOND-FINISHED, MADE OF 22 MM MEDIUM DENSITY WOOD FIBRE (MDF) PANELS, VENEERED WITH THE SAME VENEERED WOOD AS THE PERIMETER PROFILES. THESE DOORS, THANKS TO THE UNION OF THE VARIOUS WOODEN PROFILES WITH PANELS AND/OR GLASS, CAN GIVE RISE TO DIFFERENT DESIGNS AND VARIATIONS. THE DOORS ARE ASSEMBLED USING WOODEN PINS AND VINYL GLUING. FOR THE WINDOW VERSION, THE UPPER CROSSBAR IS ANCHORED TO THE UPRIGHTS USING MECHANICAL JOINTS. THE SHAPED PART OF THE UPRIGHTS CREATE THE SEAT TO ACCOMMODATE PANELS AND GLASS. THE GLASS HAVE MM. 6 THICKNESS AND ARE SURROUNDED BY A SPECIAL CO-EXTRUDED GASKET THAT ACTS AS AN INSULATION BETWEEN THE WOODEN PROFILE AND THE GLASS ITSELF. FOR ALL THE OTHER VERSIONS WHERE THE GLASS IS NOT SUPPLIED BY AIP S.R.L., THE RELATIVE ASSEMBLY OF THE GLASS IS CARRIED OUT BY THE INSTALLER, WHO PUTS THE GLASS IN PLACE WITH A SUITABLE FIXING SYSTEM. COLOURS, PATINATES OR OPEN-PORE LACQUERS ARE WATER-BASED FINISHES.

FITTINGS: THREE Ø 13 MM SINGLE-STEMMED ANUBA HINGES WITH RELATIVE ANUBA-COVER CAPS, SMALL PATENT LOCK (ONLY LATCH) ON THE FRONT 18 MM, AVAILABLE IN MATT CHROME, POLISHED CHROME AND POLISHED BRASS FINISHES, OR MAGNETIC LOCK IN SATIN CHROME, POLISHED CHROME OR WHITE FINISHES. SWING THICKNESS 44 MM.



MGN1



MGN1-F



MGN2



MGN2-F



MGN3



MGN3-F



MGN5



MGN5-F



MGN10



MGN10-F



MGN11



MGN11-F



MGN13



MGN13-F



MGN14



MGN14-F





Finiture **di stile**

STYLE FINISHES

Se già le collezioni di Sololegno sorprendono con la loro varietà, le soluzioni tecniche che rendono possibile il sogno di farle entrare in casa propria e adattarle ai propri spazi e gusti lasciano senza parole. Quasi non si contano, infatti, le finiture disponibili per ciascuna linea, così come numerosi e differenti sono i sistemi di apertura (a battente o scorrevoli) e le soluzioni di maniglie. Non semplici dettagli, ma elementi indispensabili per far sposare il design o la tradizione di una porta in legno con ogni tipo di ambiente. Finiture di stile per spazi che conquistano.

IF ALREADY THE SOLOLEGNO COLLECTIONS SURPRISE WITH THEIR VARIETY, THE TECHNICAL SOLUTIONS THAT MAKE POSSIBLE THE DREAM OF LETTING THEM COME INTO THEIR OWN HOME AND ADAPT THEM TO THEIR OWN SPACES AND TASTES LEAVE THEM SPEECHLESS. IN FACT, THERE ARE ALMOST NO FINISHES AVAILABLE FOR EACH LINE, AS ARE NUMEROUS AND DIFFERENT OPENING SYSTEMS (HINGED OR SLIDING) AND HANDLE SOLUTIONS. NOT SIMPLE DETAILS, BUT INDISPENSABLE ELEMENTS TO COMBINE THE DESIGN OR THE TRADITION OF A WOODEN DOOR WITH EVERY TYPE OF ENVIRONMENT. STYLE FINISHES FOR CONQUERING SPACES.

Rovere

Rovere *tinto* spazzolato

BRUSHED DYED OAK

Tra i legni di uso comune più pregiati, caratterizzato da belle venature, che risaltano, creando un effetto estetico molto gradevole. E' un legno molto robusto, garantendo una tenuta nel tempo di alto livello. Il legno di Rovere, nella sua colorazione naturale, si presta molto bene per le tinte effetto naturale, o leggermente tintate.

IT IS AMONG THE MOST VALUABLE WOODS IN COMMON USE, CHARACTERIZED BY BEAUTIFUL VEINS, WHICH STAND OUT, CREATING A VERY PLEASANT AESTHETIC EFFECT. IT IS A VERY ROBUST WOOD, GUARANTEEING A HIGH LEVEL OF DURABILITY. OAK WOOD, IN ITS NATURAL COLOR, LENDS ITSELF VERY WELL TO NATURAL OR SLIGHTLY DYED EFFECT COLORS.



- LINEAIDEA ●
- STILIDEA ●
- FIABIDEA ●
- RESET ●
- PRESTIGE ●
- IDEALE ●
- CONCERTO ●
- IMAGINE ●
- SINTESI ●
- ESSENZA ●
- LIVING ●



Rovere *tinto* CANALETTO
DYED OAK CANALETTO



Rovere *tinto* COGNAC
DYED OAK COGNAC



Rovere *tinto* GRIGIO EVO
DYED OAK GRIGIO EVO



Rovere *tinto* QUERCIA DARK
DYED OAK QUERCIA DARK

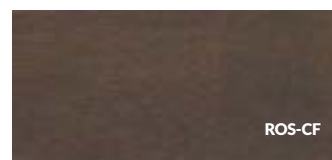

Rovere *tinto* CAFFÈ
DYED OAK CAFFÈ



Rovere *tinto* MASCARA
DYED OAK MASCARA



Rovere *tinto* BIANCO PERLATO
DYED OAK BIANCO PERLATO



Rovere *tinto* EFFETTO NATURALE
DYED OAK EFFETTO NATURALE



Rovere *tinto* NOCCIOLA
DYED OAK NOCCIOLA

Rovere *laccato* spazzolato

BRUSHED LACQUERED OAK

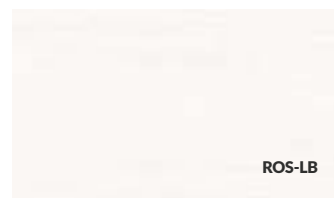

Rovere *laccato* BIANCO PORO
LACQUERED OAK BIANCO PORO

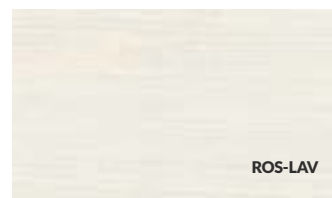

Rovere *laccato* AVORIO
LACQUERED OAK AVORIO



Rovere *laccato* GRIGIO
LACQUERED OAK GRIGIO

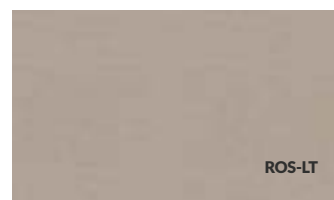

Rovere *laccato* TORTORA
LACQUERED OAK TORTORA



Rovere *laccato* BLU
LACQUERED OAK BLU

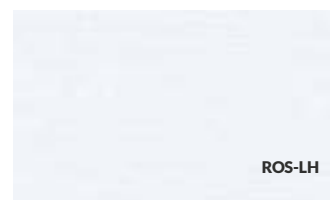

Rovere *laccato* GHIACCIO
LACQUERED OAK GHIACCIO

- LINEAIDEA ●
- STILIDEA ●
- FIABIDEA ●
- RESET ●
- PRESTIGE ●
- IDEALE ●
- CONCERTO ●
- IMAGINE ●
- SINTESI ●
- ESSENZA ●
- LIVING ●

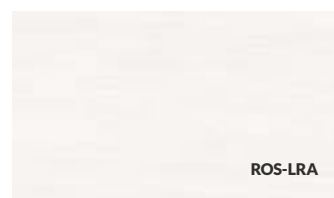

Rovere *laccato* CANDY
LACQUERED OAK CANDY



Rovere *lac.* ACQUAMARINA
LACQUERED OAK ACQUAMARINA



*Finiture riproducibili
in qualunque tinta RAL*

REPRODUCIBLE FINISHES IN ANY RAL COLOR

Rovere Natural

Rovere Natural **tinto** spazzolato

DYED STAINED NATURAL OAK



RND-EN

Rovere Natural **tinto** **EFFETTO NATURALE**
DYED NATURAL OAK EFFETTO NATURALE



RND-CN

Rovere Natural **tinto** **CANALETTO**
DYED NATURAL OAK CANALETTO

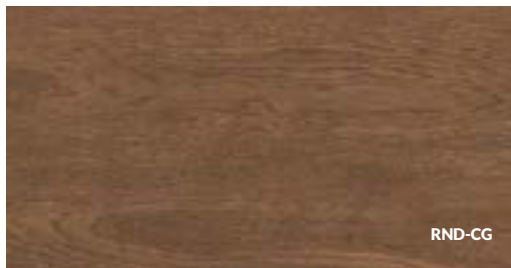

RND-CG

Rovere Natural **tinto** **COGNAC**
DYED NATURAL OAK TINTO COGNAC



RND-DK

Rovere Natural **tinto** **QUERCIA DARK**
DYED NATURAL OAK QUERCIA DARK

Rovere Natural **patinato** spazzolato

BRUSHED PATINATED NATURAL OAK



RND-PBN

Rovere Natural **patinato** **BIANCO NEVE**
PATINATED NATURAL OAK BIANCO NEVE



RND-PGV

Rovere Natural **patinato** **GRIGIO EVO**
PATINATED NATURAL OAK GRIGIO EVO



RND-PMA

Rovere Natural **patinato** **MASCARA**
PATINATED NATURAL OAK MASCARA



RND-PNC

Rovere Natural **patinato** **NOCCIOLA**
PATINATED NATURAL OAK NOCCIOLA

- LINEAIDEA
- STILIDEA
- FIABIDEA
- RESET
- PRESTIGE
- IDEALE
- CONCERTO
- IMAGINE
- SINTESI
- ESSENZA
- LIVING

Di colore più maturo del precedente, si ottiene dalla lavorazione dei tronchi di querce di medie dimensioni. E' un materiale molto duro, con nodi a vista, belle venature marcate e fiamme circolari, tipiche del legno massello.

OF A MORE MATURE COLOR THAN THE PREVIOUS ONE, IT IS OBTAINED BY PROCESSING MEDIUM-SIZED OAK TRUNKS. IT IS A VERY HARD MATERIAL, WITH VISIBLE KNOTS, BEAUTIFUL MARKED VEINS AND CIRCULAR FLAMES, TYPICAL OF SOLID WOOD.

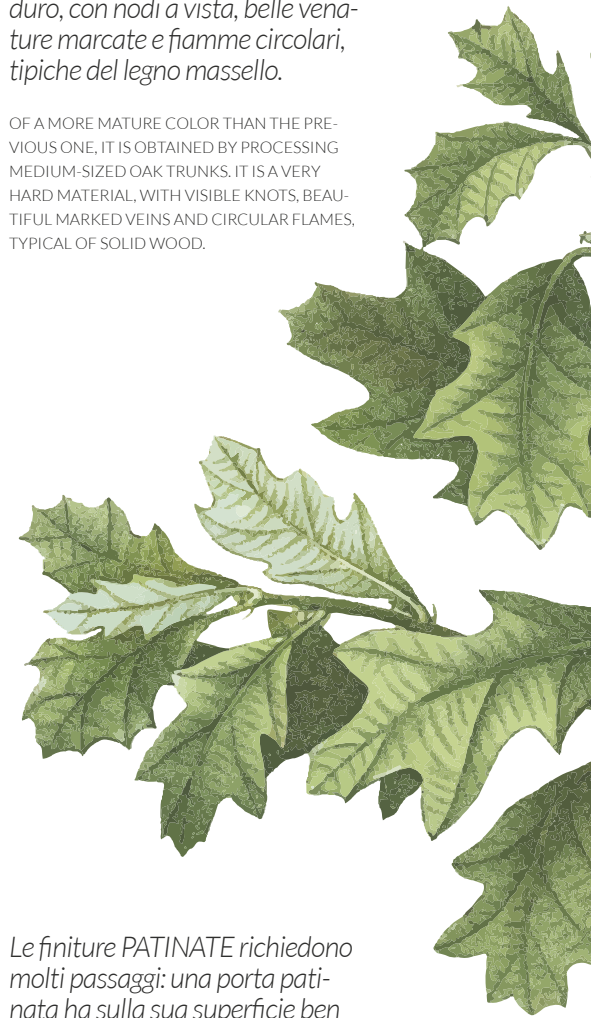

Le finiture PATINATE richiedono molti passaggi: una porta patinata ha sulla sua superficie ben 4 mani di verniciatura, tra fondi, patine e finiture, con altrettanti trattamenti manuali di carteggiature e stracciature, che fanno risaltare le caratteristiche naturali del legno, come le venature ed i pori, creando un effetto lente sulle superfici.

THE PATINATE FINISHES REQUIRE MANY STEPS: A COATED DOOR HAS 4 COATS OF PAINT ON ITS SURFACE, INCLUDING BASE COATS, PATINAS AND FINISHES, WITH AS MANY MANUAL SANDING AND SCRAPING TREATMENTS, WHICH BRING OUT THE NATURAL CHARACTERISTICS OF THE WOOD, SUCH AS THE GRAIN AND PORES, CREATING A LENS EFFECT ON SURFACES.

- LINEAIDEA
- STILIDEA
- FIABIDEA
- RESET
- PRESTIGE
- IDEALE
- CONCERTO
- IMAGINE
- SINTESI
- ESSENZA
- LIVING

Frassino

Frassino **tinto** spazzolato

BRUSHED DYED ASH

È tra i legni usati più belli dal punto di vista estetico, grazie alle sue ampie fiamme a cattedrale, facile da spazzolare, esaltando al massimo la venatura del legno anche da un punto di vista tattile. Molto adatto alle laccature effetto a poro aperto, proprio perché la tecnica di spazzolatura favorisce la penetrazione delle vernici.

IT IS AMONG THE MOST BEAUTIFUL WOODS USED FROM THE AESTHETIC POINT OF VIEW, THANKS TO ITS LARGE CATHEDRAL FLAMES, EASY TO BRUSH, ENHANCING THE GRAIN OF THE WOOD TO THE MAXIMUM EVEN FROM A POINT OF TACTILE SIGHT. VERY SUITABLE FOR OPEN PORE LACQUERING, PRECISELY BECAUSE THE BRUSHING TECHNIQUE FAVORS THE PENETRATION OF PAINTS.



- LINEAIDEA ●
- STILIDEA ●
- FIABIDEA ●
- RESET ●
- PRESTIGE ●
- IDEALE ●
- CONCERTO ●
- IMAGINE ●
- SINTESI ●
- ESSENZA ●
- LIVING ●



Frassino tinto **CANALETTO**
DYED ASH CANALETTO



Frassino tinto **COGNAC**
DYED ASH COGNAC



Frassino tinto **QUERCIA DARK**
DYED ASH DARK



Frassino tinto **CAFFÈ**
DYED ASH CAFFÈ



Frassino tinto **BIANCO PERLATO**
DYED ASH BIANCO PERLATO



Frassino tinto **NOCCIOLA**
DYED ASH TINTO NOCCIOLA



Frassino tinto **MASCARA**
DYED ASH MASCARA



Frassino tinto **GRIGIO EVO**
DYED ASH GRIGIO EVO

Frassino **laccato** spazzolato

BRUSHED LACQUERED ASH



FRS-LB

Frassino lac. **BIANCO PORO**
LACQUERED ASH BIANCO PORO



FRS-LAV

Frassino laccato **AVORIO**
LACQUERED ASH AVORIO



FRS-LG

Frassino laccato **GRIGIO**
LACQUERED ASH GRIGIO



FRS-LT

Frassino laccato **TORTORA**
LACQUERED ASH TORTORA

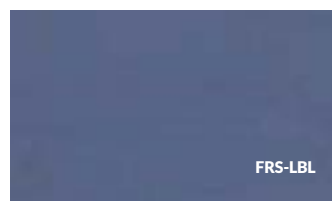

FRS-LBL

Frassino laccato **BLU**
LACQUERED ASH BLU

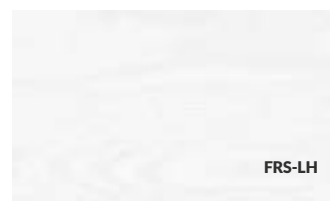

FRS-LH

Frassino laccato **GHIACCIO**
LACQUERED ASH GHIACCIO

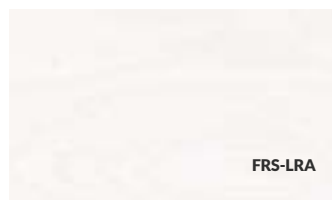

FRS-LRA

Frassino laccato **CANDY**
LACQUERED ASH CANDY

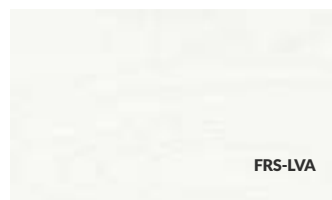

FRS-LVA

Frassino lac. **ACQUAMARINA**
LACQUERED ASH ACQUAMARINA

Finiture riproducibili
in qualunque tinta RAL

REPRODUCIBLE FINISHES IN ANY RAL COLOR



- LINEAIDEA
- STILIDEA
- FIABIDEA
- RESET
- PRESTIGE
- IDEALE
- CONCERTO
- IMAGINE
- SINTESI
- ESSENZA
- LIVING

Frassino **patinato** spazzolato

BRUSHED PATINATED ASH



FRS-PBN

Frassino patinato **BIANCO NEVE**
PATINATED ASH BIANCO NEVE



FRS-PNC

Frassino patinato **NOCCIOLA**
PATINATED ASH NOCCIOLA



FRS-PMA

Frassino patinato **MASCARA**
PATINATED ASH MASCARA



FRS-PGV

Frassino patinato **GRIGIO EVO**
PATINATED ASH GRIGIO EVO

- LINEAIDEA
- STILIDEA
- FIABIDEA
- RESET
- PRESTIGE
- IDEALE
- CONCERTO
- IMAGINE
- SINTESI
- ESSENZA
- LIVING

Le finiture PATINATE richiedono molti passaggi: una porta patinata ha sulla sua superficie ben 4 mani di verniciatura, tra fondi, patine e finiture, con altrettanti trattamenti manuali di carteggiature e stracciature, che fanno risaltare le caratteristiche naturali del legno, come le venature ed i pori, creando un effetto lente sulle superfici.

THE PATINATE FINISHES REQUIRE MANY STEPS: A COATED DOOR HAS 4 COATS OF PAINT ON ITS SURFACE, INCLUDING BASE COATS, PATINAS AND FINISHES, WITH AS MANY MANUAL SANDING AND SCRAPING TREATMENTS, WHICH BRING OUT THE NATURAL CHARACTERISTICS OF THE WOOD, SUCH AS THE GRAIN AND PORES, CREATING A LENS EFFECT ON SURFACES.



Tranciato ricavato da masselli anticati in modo naturale di travi strutturali di vecchie case, poi lavorato e giuntato ricreando una splendida fusione di colori e design, conservando anche tutte le "difettosità" del legno madre, come nodi, crepe, buchi dovuti a tarli o chiodi, dando nell'insieme una piacevole sensazione al tatto. Le verniciature scelte esaltano al massimo questi particolari legni, dando la possibilità a questo materiale così prezioso di continuare a vivere nel tempo, con diversità di tonalità e sfumature uniche, in modo che tutte le superfici saranno simili tra loro ma mai uguali.

SLICED VENEER MADE FROM NATURALLY ANTIQUED SOLID WOOD BEAMS OF OLD HOUSES, THEN WORKED AND JOINED TOGETHER TO RECREATE A SPLENDID FUSION OF COLORS AND DESIGN, ALSO PRESERVING ALL THE "DEFECTS" OF THE MOTHER WOOD, LIKE KNOTS, CRACKS, HOLES DUE TO WOODWORMS OR NAILS, GIVING A PLEASANT SENSATION TO THE WHOLE. THE CHOSEN PAINTS ENHANCE THESE PARTICULAR WOODS TO THE MAXIMUM, GIVING THE POSSIBILITY TO THIS MATERIAL SO PRECIOUS TO CONTINUE TO LIVE OVER TIME, WITH DIVERSITY OF SHADES AND UNIQUE NUANCES, SO THAT ALL SURFACES WILL BE SIMILAR TO EACH OTHER BUT NEVER THE SAME.



- LINEAIDEA ●
- STILIDEA ●
- FIABIDEA ●
- RESET ●
- PRESTIGE ●
- IDEALE ●
- CONCERTO ●
- IMAGINE ●
- SINTESI ●
- ESSENZA ●
- LIVING ●

Rovere touch

OAK TOUCH



Rovere touch **EFFETTO NATURALE**
OAK TOUCH EFFETTO NATURALE



Rovere touch **CANALETTO**
OAK TOUCH CANALETTO

Abete touch

FIR TOUCH

- LINEAIDEA ●
- STILIDEA ●
- FIABIDEA ●
- RESET ●
- PRESTIGE ●
- IDEALE ●
- CONCERTO ●
- IMAGINE ●
- SINTESI ●
- ESSENZA ●
- LIVING ●



Abete touch **EFFETTO NATURALE**
FIR TOUCH EFFETTO NATURALE



Abete touch **COGNAC**
FIR TOUCH COGNAC



Abete touch **PETROLIO**
FIR TOUCH PETROLIO



Abete touch **GRAFITE**
FIR TOUCH GRAFITE



Abete touch **BRUCIATO**
FIR TOUCH BRUCIATO



Abete touch **BIANCO**
FIR TOUCH BIANCO

Laccato

Laccato opaco

MATT LACQUERED

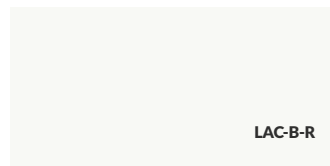

LACC-B-R

Laccato opaco **BIANCO AIP**
MATT LACQUERED BIANCO AIP

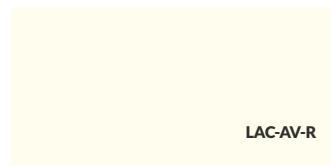

LACC-AV-R

Laccato opaco **AVORIO**
MATT LACQUERED AVORIO



LACC-CC-R

Lac. opaco **CIOCCOLATO**
MATT LACQUERED CIOCCOLATO



LACC-G-R

Laccato opaco **GRIGIO**
MATT LACQUERED GRIGIO



LACC-T-R

Laccato opaco **TORTORA**
MATT LACQUERED TORTORA

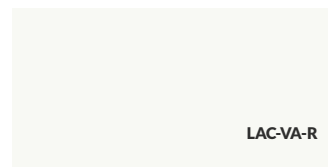

LACC-VA-R

Lac. opaco **ACQUAMARINA**
MATT LACQUERED ACQUAMARINA

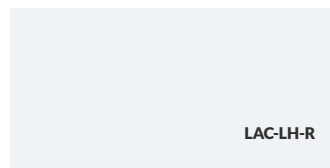

LACC-LH-R

Laccato opaco **GHIACCIO**
MATT LACQUERED GHIACCIO

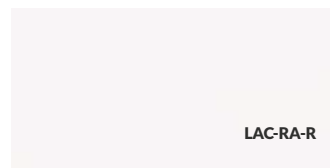

LACC-RA-R

Laccato opaco **CANDY**
MATT LACQUERED CANDY



LACC-BL-R

Laccato opaco **BLU**
MATT LACQUERED BLU

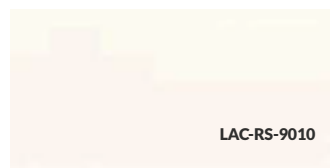

LACC-RS-9010

Lac. opaco **BIANCO RAL 9010**
MATT LACQUERED BIANCO RAL 9010

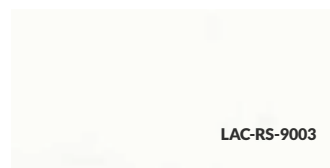

LACC-RS-9003

Lac. opaco **BIANCO RAL 9003**
MATT LACQUERED BIANCO RAL 9003

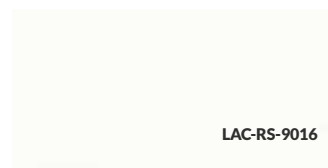

LACC-RS-9016

Lac. opaco **BIANCO RAL 9016**
MATT LACQUERED BIANCO RAL 9016

- LINEAIDEA
- STILIDEA
- FIABIDEA
- RESET
- PRESTIGE
- IDEALE
- CONCERTO
- IMAGINE
- SINTESI
- ESSENZA
- LIVING

La laccatura è un tipo di verniciatura che prevede l'applicazione una vernice coprente colorata (comunemente chiamata lacca) che nasconde le venature del materiale di supporto.

La laccatura può essere di due tipi: opaca (assorbe la luce) oppure satinata - effetto seta (morbida e vellutata al tatto, riflette solo la luce).

LACQUERING IS A TYPE OF PAINTING THAT INVOLVES APPLYING A COLORED COVERING PAINT (COMMONLY CALLED LACQUER) THAT HIDES THE VEINING OF THE SUPPORT MATERIAL. THE LACQUERING CAN BE OF TWO TYPES: MATT (ABSORBS THE LIGHT) OR SATIN - SILK EFFECT (SOFT AND VELVETY TO THE TOUCH, REFLECTS ONLY THE LIGHT).



Finiture riproducibili in qualunque tinta RAL

REPRODUCIBLE FINISHES IN ANY RAL COLOR

Laccato effetto seta

LACQUERED SILK EFFECT

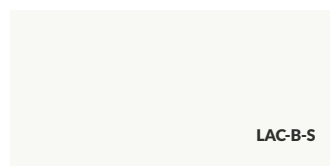

LACC-B-S

Laccato seta **BIANCO AIP**
LACQUERED SILK BIANCO AIP

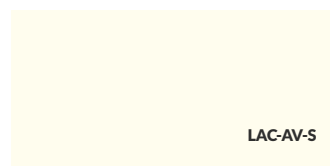

LACC-AV-S

Laccato seta **AVORIO**
LACQUERED SILK AVORIO



LACC-T-S

Laccato seta **TORTORA**
LACQUERED SILK TORTORA



LACC-G-S

Laccato seta **GRIGIO**
LACQUERED SILK GRIGIO

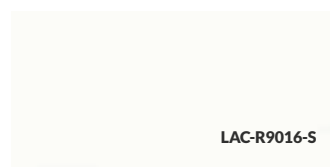

LACC-R9016-S

Laccato seta **BIANCO**
LACQUERED SILK BIANCO

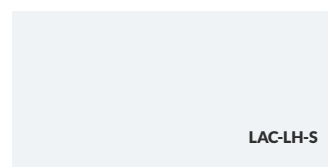

LACC-LH-S

Laccato seta **GHIACCIO**
LACQUERED SILK GHIACCIO

- LINEAIDEA
- STILIDEA
- FIABIDEA
- RESET
- PRESTIGE
- IDEALE
- CONCERTO
- IMAGINE
- SINTESI
- ESSENZA
- LIVING



Laccato Living

LACQUERED LIVING

- LINEAIDEA ●
- STILIDEA ●
- FIABIDEA ●
- RESET ●
- PRESTIGE ●
- IDEALE ●
- CONCERTO ●
- IMAGINE ●
- SINTESI ●
- ESSENZA ●
- LIVING ●



LAC-LB

Laccato Living **BIANCO PORO**
LACQUERED LIVING BIANCO AIP



LAC-LAV

Laccato Living **AVORIO**
LACQUERED LIVING AVORIO



LAC-LG

Laccato Living **GRIGIO**
LACQUERED LIVING GRIGIO



LAC-LRA

Laccato Living **CANDY**
LACQUERED LIVING CANDY



LAC-LT

Laccato Living **TORTORA**
LACQUERED LIVING TORTORA



LAC-LCC

Lac. Living **CIOCCOLATO**
LACQUERED LIVING CIOCCOLATO



LAC-LVA

Lac. Living **ACQUAMARINA**
LACQUERED LIVING ACQUAMARINA



LAC-LLH

Laccato Living **GHIACCIO**
LACQUERED LIVING GHIACCIO



LAC-LBL

Laccato Living **BLU**
LACQUERED LIVING BLU

La laccatura a poro aperto è un particolare tipo di laccatura che lascia ben visibili le caratteristiche del materiale utilizzato e lascia trasparire le venature tipiche del legno. Sulla superficie della porta a poro aperto si notano molto bene pori, nodi e venature proprie di questo materiale.

OPEN-PORE LACQUERING IS A SPECIAL TYPE OF LACQUERING THAT LEAVES THE CHARACTERISTICS OF THE MATERIAL USED CLEARLY VISIBLE AND ALLOWS TO SEE THE TYPICAL WOOD VEINS. ON THE OPEN PORE SURFACE OF THE DOOR YOU CAN SEE VERY WELL THE PORES, KNOTS AND VEINS OF THIS MATERIAL.



Finiture riproducibili
in qualunque tinta RAL

REPRODUCIBLE FINISHES IN ANY RAL COLOR

Inserti

INSERT

Inserti in legno

WOODEN INSERT



Rovere Natural tinto
EFFETTO NATURALE
NATURAL EFFECT TINTED OAK

- LINEAIDEA
- STILIDEA
- FIABIDEA
- RESET
- **PRESTIGE**
- IDEALE
- CONCERTO
- IMAGINE
- SINTESI
- ESSENZA
- LIVING

FINITURE ABBINABILI

- Frassino Laccato Bianco Poro
- Frassino Laccato Avorio
- Frassino Laccato Grigio
- Frassino Laccato Tortora
- Rovere Laccato Bianco Poro
- Rovere Laccato Avorio
- Rovere Laccato Grigio
- Rovere Laccato Tortora
- Laccato Bianco AIP
- Laccato Avorio
- Laccato Grigio
- Laccato Tortora

Inserti lucidi

SHINY INSERTS

- LINEAIDEA
- STILIDEA
- FIABIDEA
- RESET
- **PRESTIGE**
- IDEALE
- **CONCERTO**
- IMAGINE
- SINTESI
- ESSENZA
- LIVING



Inserto **BIANCO**
WHITE INSERT



Inserto **BEIGE**
BEIGE INSERT

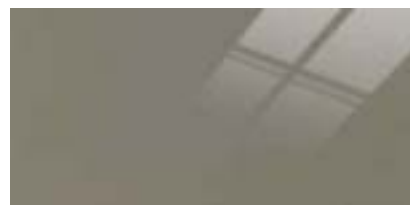

Inserto **TORTORA**
TAUPE INSERT



Inserto **GRIGIO CHIARO**
LIGHT GRAY INSERT



Inserto **GRIGIO SCURO**
DARK GRAY INSERT

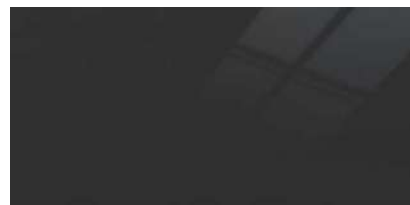

Inserto **NERO**
DARK INSERT

FINITURE ABBINABILI

- Frassino Tinto Bianco Perlato
- Frassino Patinato Bianco Neve
- Frassino Laccato Bianco Poro
- Rovere Bianco Perlato
- Rovere Effetto Naturale
- Rovere Patinato Bianco Neve
- Rovere Laccato Bianco Poro
- Rovere Natural effetto naturale
- Laccato Bianco AIP
- Laccato Bianco R9016 - R9010 - R9003

- Frassino Tinto Nocciola
- Frassino Patinato Nocciola
- Frassino Laccato Avorio
- Rovere Tinto Nocciola
- Rovere Patinato Nocciola
- Rovere Laccato Avorio
- Laccato Avorio

- Frassino Tinto Canaletto
- Frassino Tinto Mascara
- Frassino Patinato Mascara
- Frassino Laccato Tortora
- Rovere Tinto Canaletto
- Rovere Tinto Mascara
- Rovere Patinato Mascara
- Rovere Laccato Tortora
- Laccato Tortora

- Frassino Laccato Grigio
- Rovere Laccato Grigio
- Laccato Grigio

- Frassino Tinto Quercia Dark
- Frassino Tinto Grigio Evo
- Frassino Patinato Grigio Evo
- Rovere Tinto Quercia Dark
- Rovere Tinto Grigio Evo
- Rovere Patinato Grigio Evo

- Frassino Tinto Cognac
- Frassino Tinto Caffè
- Rovere Tinto Cognac
- Rovere Tinto Caffè

Inserti in pietra

STONE INSERTS



Pietra **VIENNA**
STONE VIENNA

- LINEAIDEA
- STILIDEA
- FIABIDEA
- RESET
- **PRESTIGE**
- IDEALE
- CONCERTO
- IMAGINE
- SINTESI
- ESSENZA
- LIVING

FINITURE ABBINABILI

- Frassino Tinto: tutti i colori
- Frassino Patinato: tutti i colori
- Frassino Laccato: tutti i colori
- Rovere Tinto: tutti i colori
- Rovere Natural Patinato: tutti i colori
- Rovere Laccato: tutti i colori
- Laccato: tutti i colori

Soluzioni tecniche

INTERNAL STRUCTURE OF THE DOOR

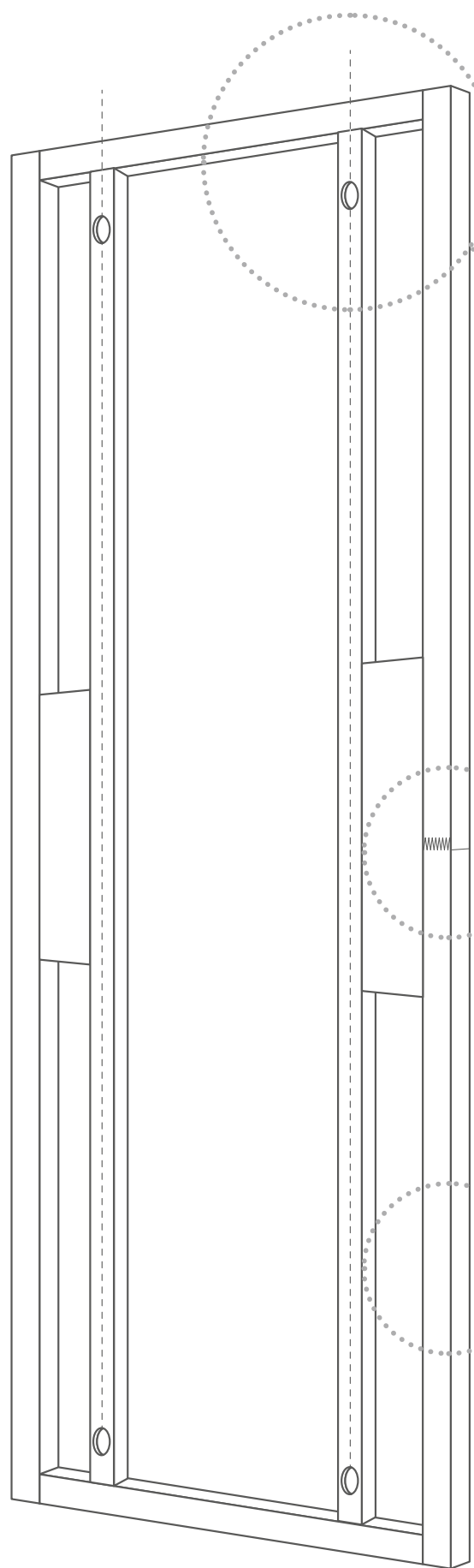

Doppio tirante

DOUBLE TIE ROD

La struttura è tesa longitudinalmente da due tiranti che ne garantiscono la indeformabilità e la mantengono in assetto. L'accesso tramite i fori superiori consente una facilità di intervento ed una semplice manutenzione. Di serie sulle ante superiori a 230 cm, a richiesta su misure inferiori.

THE STRUCTURE IS STRETCHED LONGITUDINALLY BY TWO TIE RODS THAT GUARANTEE ITS NON-DEFORMABILITY AND KEEP IT IN TRIM. ACCESS THROUGH THE UPPER HOLES ALLOWS EASY INTERVENTION AND SIMPLE MAINTENANCE. STANDARD ON THE UPPER DOORS OF 230 CM, ON REQUEST ON SMALLER SIZES.

Giunti a pettine

COUPLING TO COMB

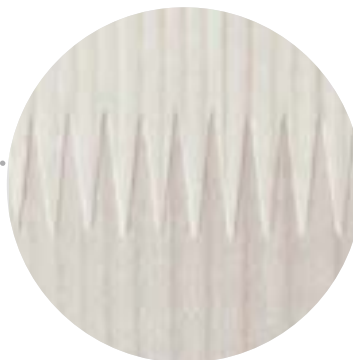

La parti con nodi vengono sostituite da parti giuntate a pettine: ciò consente una stabilità maggiore nel tempo e una minore distorsione.

THE PARTS WITH KNOTS ARE REPLACED BY COMB-LIKE PARTS: THIS ALLOWS GREATER STABILITY OVER TIME AND LESS DISTORTION.

Bordatura perimetrale

PERIMETER EDGING

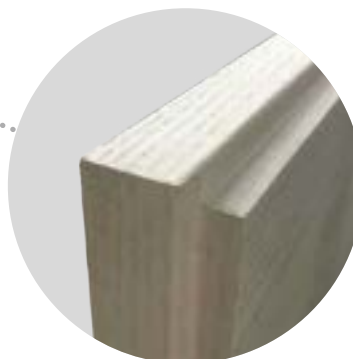

La bordatura sui 3 lati visibili dell'anta esalta l'eleganza e l'estetica della porta e ne garantisce la protezione.

THE EDGING ON THE 3 VISIBLE SIDES OF THE DOOR ENHANCES THE ELEGANCE AND AESTHETICS OF THE DOOR AND GUARANTEES ITS PROTECTION.

Sistemi di apertura a battente

SWING OPENING SYSTEMS

The logo for SOLOLEGNO, featuring a stylized white leaf or feather icon to the left of the brand name in a clean, sans-serif font.

SOLOLEGNO

Apertura a battente *complanare*

COPLANAR SWING OPENING

- LINEAIDEA
- STILIDEA
- FIABIDEA
- RESET
- PRESTIGE
- IDEALE
- CONCERTO
- IMAGINE
- SINTESI
- ESSENZA
- LIVING



- LINEAIDEA
- STILIDEA
- FIABIDEA
- RESET
- PRESTIGE
- IDEALE
- CONCERTO
- IMAGINE
- SINTESI
- ESSENZA
- LIVING



Telaio TT

Telaio con anta a filo esterno con apertura a tirare e cerniere a scomparsa

FRAME WITH EXTERNAL FLUSH DOOR WITH PULL OPENING AND CONCEALED HINGES

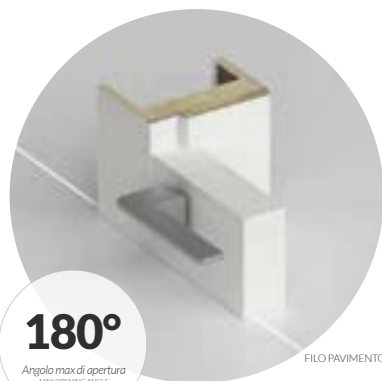

Telaio TS

Telaio con anta a filo esterno con apertura a spingere e cerniere a scomparsa

FRAME WITH EXTERNAL FLUSH DOOR WITH PUSH OPENING AND CONCEALED HINGES

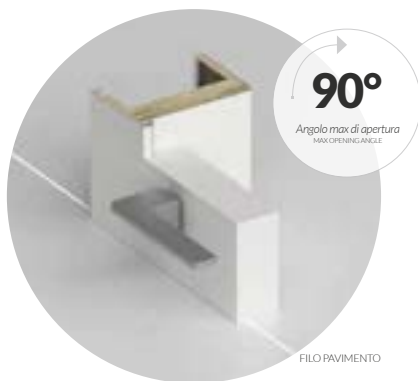

Telaio LT

Telaio con anta a filo esterno con apertura a tirare e cerniere a bilico invisibili

FRAME WITH EXTERNAL FLUSH DOOR WITH PULL OPENING AND INVISIBLE PIVOT HINGES

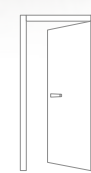

Telaio LS

Telaio con anta a filo esterno con apertura a spingere e cerniere a scomparsa

FRAME WITH EXTERNAL FLUSH DOOR WITH PUSH OPENING AND CONCEALED HINGES

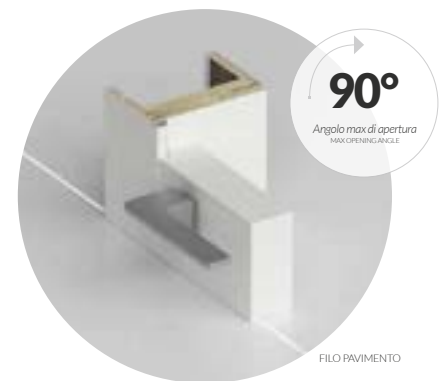

Tutti i telai complanari montano solo **cerniere a scomparsa**, ad eccezione del telaio **LT** che monta solo cerniere **a bilico invisibili**



ALL THE COPLANAR FRAMES MOUNT ONLY CONCEALED HINGES, WITH THE EXCEPTION OF THE LT FRAME WHICH ONLY FEATURES INVISIBLE PIVOT HINGES

Apertura a battente con cerniere a scomparsa

HINGED OPENING WITH CONCEALED HINGES

- LINEAIDEA ●
- STILIDEA ●
- FIABIDEA ●
- RESET ●
- PRESTIGE ●
- IDEALE ●
- CONCERTO ●
- IMAGINE ●
- SINTESI ●
- ESSENZA ●
- LIVING ●



- LINEAIDEA
- STILIDEA
- FIABIDEA
- RESET
- PRESTIGE
- IDEALE
- CONCERTO
- IMAGINE
- SINTESI
- ESSENZA
- LIVING



Telaio **TN**

Telaio classico con cerniere a scomparsa

CLASSIC FRAME WITH CONCEALED HINGES



Telaio **D1**

Telaio classico con cerniere a scomparsa

CLASSIC FRAME WITH CONCEALED HINGES

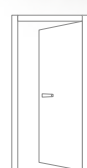

Telaio **D5**

Telaio classico con cerniere a scomparsa

CLASSIC FRAME WITH CONCEALED HINGES



*Tutti i telai **TN**, **D1** e **D5** montano esclusivamente cerniere a scomparsa*

ALL THE TN, D1 AND D5 FRAMES ARE FITTED EXCLUSIVELY WITH CONCEALED HINGES

Apertura a battente con cerniere anuba

HINGED OPENING WITH ANUBA HINGES



- LINEAIDEA
- STILIDEA
- FIABIDEA
- RESET
- PRESTIGE
- IDEALE
- CONCERTO
- IMAGINE
- SINTESI
- ESSENZA
- LIVING



Telaio T1

Telaio classico con cerniere anuba

CLASSIC FRAME WITH ANUBA HINGES



Telaio T2/T3

Telaio classico con cerniere anuba

CLASSIC FRAME WITH ANUBA HINGES

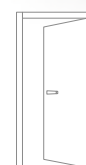

Telaio T5

Telaio classico con cerniere anuba

CLASSIC FRAME WITH ANUBA HINGES



● disponibile ● disponibile, ma con limitazioni ● NON disponibile

Tutti i telai **T1**, **T2/T3** e **T5** montano esclusivamente **cerniere anuba**

ALL FRAMES T1, T2/ T3 AND T5 ARE EXCLUSIVELY FITTED WITH ANUBA HINGES



Apertura a battente *Miniwall*

MINIWALL SWING OPENING

- LINEAIDEA ●
- STILIDEA ●
- FIABIDEA ●
- RESET ●
- PRESTIGE ●
- IDEALE ●
- CONCERTO ●
- IMAGINE ●
- SINTESI ●
- ESSENZA ●
- LIVING ●



270^{CM}
h max



Telaio **RS** a tirare

Telaio invisibile con anta a tirare a filo muro con cerniere a scomparsa

INVISIBLE FRAME WITH DOOR TO PULL FLUSH WITH THE WALL WITH CONCEALED HINGES



Telaio **RS** a spingere

Telaio invisibile con anta a spingere a filo muro con cerniere a scomparsa

INVISIBLE FRAME WITH DOOR TO PUSH FLUSH WITH THE WALL WITH CONCEALED HINGES



*Tutti i telai RS a spingere e a tirare montano esclusivamente **cerniere a scomparsa***

ALL THE RS FRAMES TO PUSH AND TO PULL ARE MOUNTED EXCLUSIVELY WITH CONCEALED HINGES

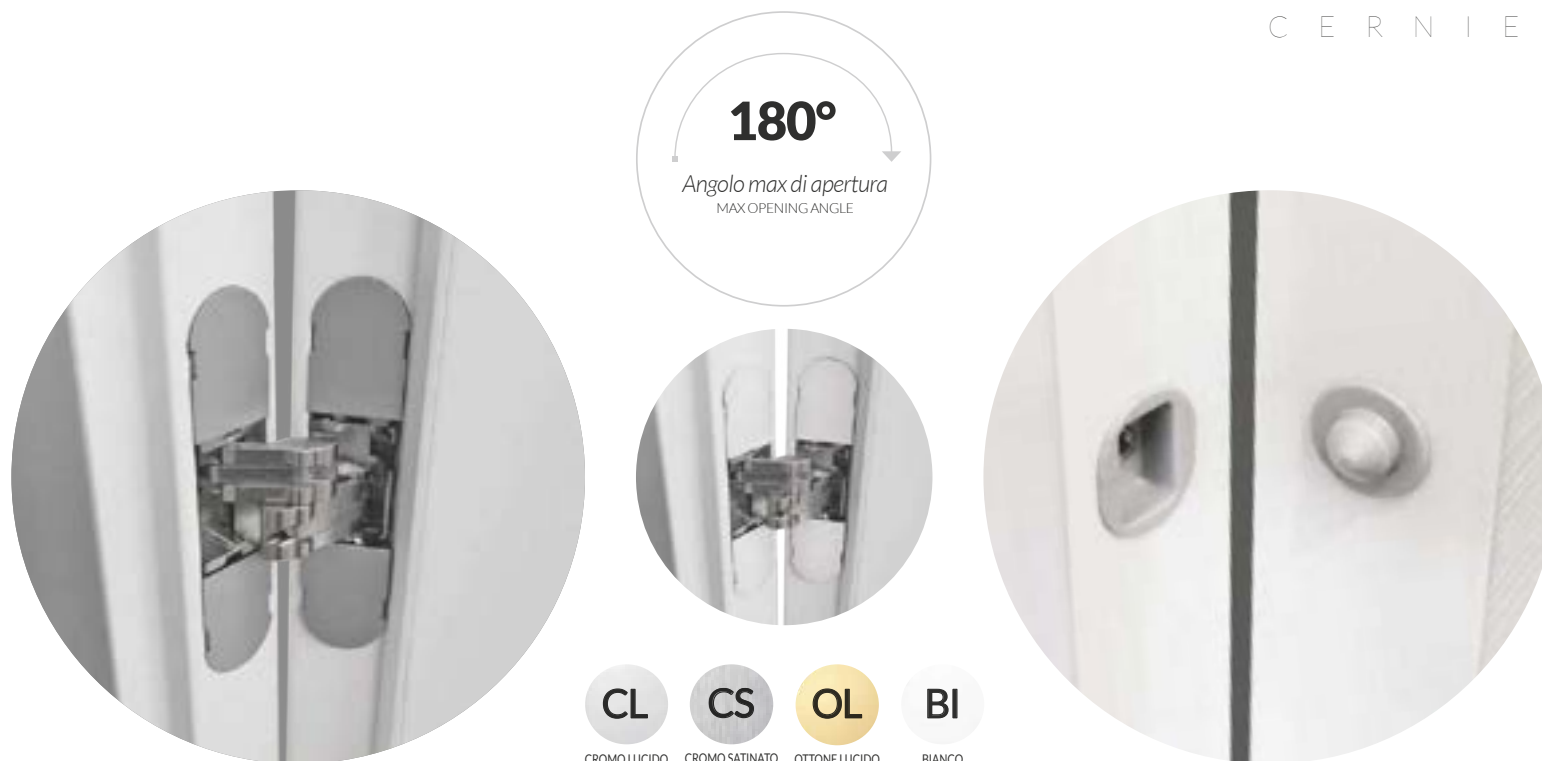

Cerniera a **Scomparsa**

Cerniera a scomparsa: regolabile in tre dimensioni, esalta eleganza ed estetica della porta. L'applicazione di tre cerniere garantisce la massima solidità. In alternativa è possibile inserire due cerniere e un rostrino centrale per le ante tamburate più leggere.

CONCEALED HINGE: ADJUSTABLE IN THREE DIMENSIONS, ENHANCES THE ELEGANCE AND AESTHETICS OF THE DOOR. THE APPLICATION OF THREE HINGES ENSURES MAXIMUM SOLIDITY. AS AN ALTERNATIVE IT IS POSSIBLE TO INSERT TWO HINGES AND A CENTRAL ROSTRIN.



Cerniera **Anuba**

Le cerniere anuba sono formate da un corpo cilindrico in due parti, maschio e femmina, e due perni filettati che si inseriscono profondamente nell'anta e nel telaio. Possono essere fornite con cappucci copri-anuba nelle finiture cromo lucido, cromo satinato, ottone lucido e bronzo.

ANUBA HINGES ARE FORMED BY A CYLINDRICAL BODY IN TWO PARTS, MALE AND FEMALE, AND TWO THREADED PINS THAT ARE INSERTED DEEPLY INTO THE DOOR AND INTO THE FRAME. THEY CAN BE SUPPLIED WITH ANUBA COVER CAPS IN THE FINISHES POLISHED CHROME, SATIN CHROME, POLISHED BRASS AND BRONZE.

⚠ Disponibile solo su telai **T1, T2/T3 e T5**



Cerniera a **Bilico** invisibile

Cerniera a bilico invisibile: unisce alla possibilità di inversione del senso di apertura il vantaggio estetico di pulizia delle linee. Senso di apertura reversibile per porte h 210 cm

INVISIBLE PIVOT HINGE: COMBINES THE POSSIBILITY OF REVERSING THE OPENING DIRECTION WITH THE AESTHETIC ADVANTAGE OF CLEANING THE LINES. REVERSIBLE OPENING DIRECTION FOR 210 CM DOORS

⚠ Disponibile solo su telaio **LT** sulla collezione **Living**

Apertura Alterno

ALTERNO OPENING



- Telai
- TS
 - TT
 - LS
 - LT
 - TN
 - D1
 - D5
 - T1
 - T2/T3
 - T5
 - RS

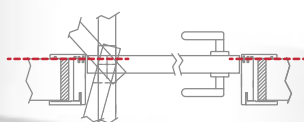
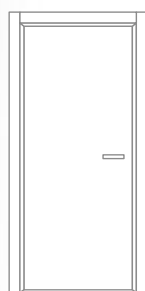

Porta con movimento bilaterale con doppio senso di apertura. Chiusura di serie con serratura magnetica e maniglia tradizionale. Chiusura opzionale con doppio magnete, in questo caso non consente la chiusura a chiave.

DOOR WITH BILATERAL MOVEMENT WITH DOUBLE OPENING SENSE. STANDARD CLOSURE WITH MAGNETIC LOCK AND TRADITIONAL HANDLE. OPTIONAL CLOSURE WITH DOUBLE MAGNET, IN THIS CASE DOES NOT ALLOW LOCKING.



Apertura Traslo

SENZA BATTUTA

TRASLO OPENING



- Telai
- TS
 - TT
 - LS
 - LT
 - TN
 - D1
 - D5
 - T1
 - T2/T3
 - T5
 - RS

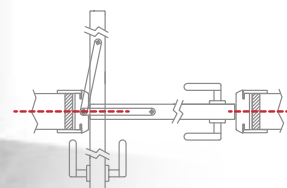
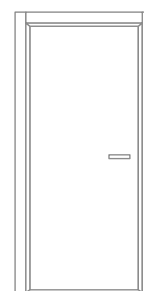

Porta ad un solo battente con movimento rototraslante con unico o doppio senso di apertura. Serratura magnetica e maniglia tradizionale.

SWINGING-SLIDING DOOR WITH ONE OR DOUBLE SENSE OF OPENNESS, MAGNETIC LOCK AND TRADITIONAL HANDLE.



Apertura Piego

PIEGO OPENING



- Telai
- TS
 - TT
 - LS
 - LT
 - TN
 - D1
 - D5
 - T1
 - T2/T3
 - T5
 - RS

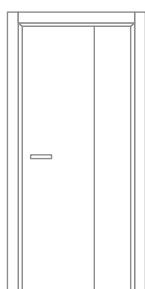

Porta pieghevole realizzata con antine asimmetriche con apertura a spinta. Apertura con maniglia e serratura tradizionali.

FOLDING DOOR MADE WITH ASYMMETRICAL DOORS WITH PUSH OPENING. OPENING WITH TRADITIONAL HANDLE AND LOCK.

Apertura Duo

DUO OPENING



- Telai
- TS
 - TT
 - LS
 - LT
 - TN
 - D1
 - D5
 - T1
 - T2/T3
 - T5
 - RS

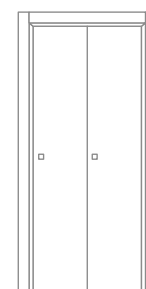

Porta pieghevole realizzata con antine simmetriche con serratura centrale e maniglie ad incasso.

FOLDING DOOR REALIZED WITH SYMMETRICAL DOORS WITH CENTRAL LOCK AND BUILT-IN HANDLES.



90°

Angolo max di apertura
MAX OPENING ANGLE



90°

Angolo max di apertura
MAX OPENING ANGLE

Sistemi di apertura scorrevoli

SLIDING OPENING SYSTEMS



Aperture scorrevoli interno muro con telaio

INTERNAL WALL SLIDING DOORS WITH FRAME

- LINEAIDEA
- STILIDEA
- FIABIDEA
- RESET
- PRESTIGE
- IDEALE
- CONCERTO
- IMAGINE
- SINTESI
- ESSENZA
- LIVING

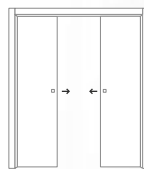

DOPPIA OPPOSTA

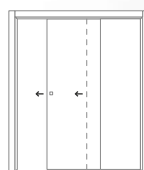

DOPPIA A STAFFETTA

270^{CM}
h max

Porta scorrevole interno muro ad anta singola o anta doppia con telaio, ideale per gli ambienti dove la porta è protagonista: il telaio fa da cornice all'anta esaltandone linee e movimenti.

INTERNAL WALL SLIDING DOOR WITH SINGLE DOOR OR DOUBLE DOOR WITH FRAME, IDEAL FOR ENVIRONMENTS WHERE THE DOOR IS THE PROTAGONIST: THE FRAME FRAMES THE DOOR ENHANCING LINES AND MOVEMENTS.

Possono montare maniglie **con e senza sistemi di chiusura**

THEY CAN MOUNT HANDLES WITH AND WITHOUT LOCKING SYSTEMS

Aperture scorrevoli interno muro senza telaio

INTERNAL WALL SLIDING DOORS WITHOUT FRAME



- LINEAIDEA
- STILIDEA
- FIABIDEA
- RESET
- PRESTIGE
- IDEALE
- CONCERTO
- IMAGINE
- SINTESI
- ESSENZA
- LIVING

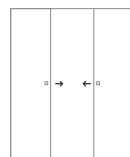

DOPPIA OPPOSTA



Le porte scorrevoli interno muro ad anta singola o ad anta doppia senza telaio esterno sono l'ideale per gli ambienti minimalisti e moderni: l'anta scompare completamente all'interno del muro.

THE INTERNAL WALL SLIDING DOORS WITH SINGLE OR DOUBLE DOORS WITHOUT EXTERNAL FRAME ARE IDEAL FOR MINIMALIST AND MODERN ENVIRONMENTS: THE DOOR DISAPPEARS COMPLETELY INSIDE THE WALL.

Aperture scorrevoli interno muro senza telaio a tutta altezza

INTERNAL WALL SLIDING DOORS WITHOUT FULL-HEIGHT FRAME

- LINEAIDEA
- STILIDEA
- FIABIDEA
- RESET
- PRESTIGE
- IDEALE
- CONCERTO
- IMAGINE
- SINTESI
- ESSENZA
- LIVING



DOPPIA OPPOSTA

270^{CM}
h max



Porte scorrevoli interno muro ad anta singola o ad anta doppia senza telaio a tutta altezza sono l'estrema sintesi tra praticità e design: le canaline di scorrimento sono inserite direttamente nel soffitto per creare un effetto total floor.

INTERNAL WALL SLIDING DOORS WITH SINGLE OR DOUBLE DOOR WITHOUT FULL-HEIGHT FRAME ARE THE EXTREME SYNTHESIS BETWEEN PRACTICALITY AND DESIGN: THE SLIDING CHANNELS ARE INSERTED DIRECTLY INTO THE CEILING TO CREATE A TOTAL FLOOR EFFECT.

Aperture scorrevoli esterno muro con telaio

EXTERNAL WALL SLIDING DOORS WITH FRAME

- LINEAIDEA
- STILIDEA
- FIABIDEA
- RESET
- PRESTIGE
- IDEALE
- CONCERTO
- IMAGINE
- SINTESI
- ESSENZA
- LIVING

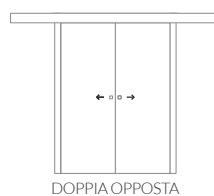

DOPPIA OPPOSTA

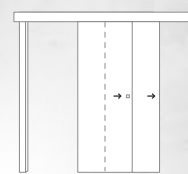

DOPPIA STAFFETTA



Porta scorrevole esterno muro ad anta singola o ad anta doppia con telaio, è l'ideale per gli ambienti dove la porta è protagonista dell'ambiente: il telaio fa da cornice all'anta esaltandone linee e movimenti. Con la mantovana in alluminio vengono fornite le coperture nella stessa finitura dell'anta.

INTERNAL WALL SLIDING DOOR WITH SINGLE DOOR OR WITH DOUBLE DOOR WITH EXTERNAL FRAME ARE IDEAL FOR ENVIRONMENTS WHERE THE DOOR IS THE PROTAGONIST OF THE ENVIRONMENT: THE FRAME FRAMES THE DOOR ENHANCING LINES AND MOVEMENTS. WITH THE ALUMINUM VALANCE COVERS ARE SUPPLIED IN THE SAME FINISH AS THE DOOR.

Aperture scorrevoli esterno muro senza telaio

SLIDING OPENINGS OUTSIDE THE WALL WITHOUT FRAME

- LINEAIDEA
- STILIDEA
- FIABIDEA
- RESET
- PRESTIGE
- IDEALE
- CONCERTO
- IMAGINE
- SINTESI
- ESSENZA
- LIVING

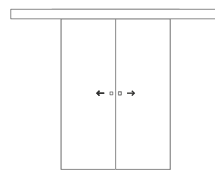

DOPPIA OPPOSTA

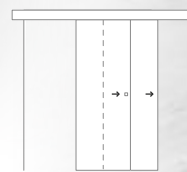

DOPPIA A STAFFETTA



Porta scorrevole esterno muro ad anta singola o ad anta doppia senza telaio è l'ideale per gli ambienti dove la porta è protagonista dell'ambiente. Vengono forniti di serie i profili di copertura della mantovana nella stessa finitura dell'anta.

INTERNAL WALL SLIDING DOOR WITH SINGLE DOOR OR DOUBLE DOOR WITHOUT EXTERNAL FRAME, IDEAL FOR ENVIRONMENTS WHERE THE DOOR IS THE PROTAGONIST OF THE ENVIRONMENT. THE COVER PROFILES OF THE VALANCE ARE SUPPLIED AS STANDARD IN THE SAME FINISH AS THE DOOR.

Aperture scorrevoli esterno muro speciali

SPECIAL EXTERNAL SLIDING WALL OPENINGS



- LINEAIDEA
- STILIDEA
- FIABIDEA
- RESET
- PRESTIGE
- IDEALE
- CONCERTO
- IMAGINE
- SINTESI
- ESSENZA
- LIVING

Lineare

Una soluzione dal design sobrio ed elegante: l'anta, ammortizzata in apertura e chiusura, scorre su un binario fissato sopra l'apertura. La guida invisibile a pavimento nella parte bassa dell'anta ne garantisce stabilità e linearità di scorrimento.



A SOLUTION WITH A SOBER AND ELEGANT DESIGN: THE DOOR, CUSHIONED IN OPENING AND CLOSING, SLIDES ON A TRACK FIXED ABOVE THE OPENING. THE INVISIBLE FLOOR GUIDE IN THE LOWER PART OF THE DOOR GUARANTEES STABILITY AND SLIDING LINEARITY.



- LINEAIDEA
- STILIDEA
- FIABIDEA
- RESET
- PRESTIGE
- IDEALE
- CONCERTO
- IMAGINE
- SINTESI
- ESSENZA
- LIVING

Tratti

Il classico sistema di apertura scorrevole esterno muro senza mantovana: l'anta è agganciata a due carrucole che corrono su un binario piatto. La guida invisibile a pavimento nella parte bassa dell'anta ne garantisce stabilità e linearità di scorrimento.

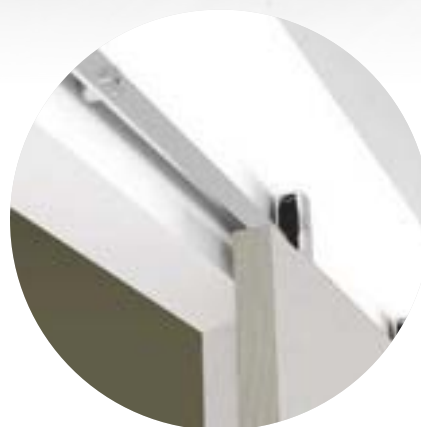

THE CLASSIC SYSTEM FOR OPENING THE EXTERNAL SLIDING DOOR WITHOUT A VALANCE: THE DOOR IS HOOKED TO TWO PULLEYS THAT RUN ON A FLAT TRACK. THE INVISIBLE FLOOR GUIDE IN THE LOWER PART OF THE DOOR GUARANTEES STABILITY AND SLIDING LINEARITY.



- LINEAIDEA
- STILIDEA
- FIABIDEA
- RESET
- PRESTIGE
- IDEALE
- CONCERTO
- IMAGINE
- SINTESI
- ESSENZA
- LIVING



- LINEAIDEA
- STILIDEA
- FIABIDEA
- RESET
- PRESTIGE
- IDEALE
- CONCERTO
- IMAGINE
- SINTESI
- ESSENZA
- LIVING

Evasione

Il trucco c'è, ma non si vede: l'anta sembra fluttuare a ridosso della parete, in realtà è ancorata ad un carrello fissato al muro. Due ruote ammortizzate inserite nella parte inferiore dell'anta garantiscono stabilità e linearità di scorrimento.



THE TRICK IS THERE, BUT YOU CAN'T SEE IT: THE DOOR SEEMS TO FLOAT CLOSE TO THE WALL. IN REALITY IT IS ANCHORED TO A TROLLEY FIXED TO THE WALL. THE INVISIBLE FLOOR GUIDE IN THE LOWER PART OF THE DOOR GUARANTEES STABILITY AND SLIDING LINEARITY.

Evoluto

Un sistema minimal che permette di ancorarsi al soffitto o a vista annegato nel cartongesso, diventando quasi un corpo unico con l'anta sottostante: si vede solo l'anta che scorre.



A MINIMAL SYSTEM THAT ALLOWS YOU TO ANCHOR TO THE CEILING OR TO VIEW DROWNED IN THE PLASTERBOARD, BECOMING ALMOST A SINGLE BODY WITH THE UNDERLYING DOOR: YOU CAN ONLY SEE THE SLIDING DOOR.

Aperture scorrevoli interno passata con telaio

SLIDING OPENINGS INTERIOR PASSED WITH FRAME

- LINEAIDEA
- STILIDEA
- FIABIDEA
- RESET
- PRESTIGE
- IDEALE
- CONCERTO
- IMAGINE
- SINTESI
- ESSENZA
- LIVING

270^{CM}
h max

X3

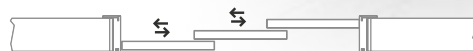

X2

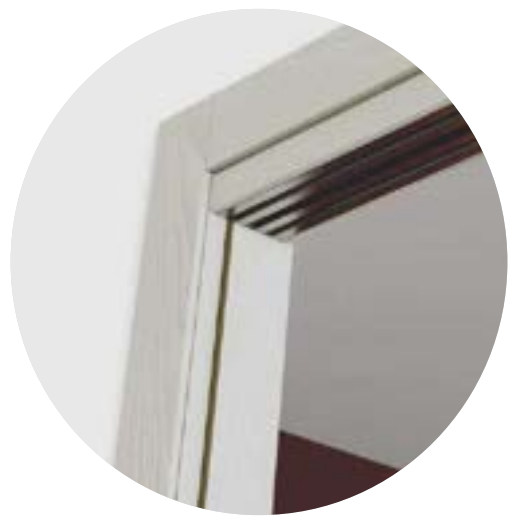

Le aperture scorrevoli interno passata con telaio sono indicate per quelle situazioni in cui va chiuso un passaggio di dimensioni importanti tra due stanze. È consigliabile quando si vuole utilizzare un'apertura a scorrimento e non è possibile installare un cassonetto interno muro. Possono essere montate fino a 4 ante.

THE INTERNAL SLIDING OPENINGS PASSED THROUGH THE FRAME ARE INDICATED FOR THOSE SITUATIONS IN WHICH AN IMPORTANT PASSAGE BETWEEN TWO ROOMS MUST BE CLOSED. IT IS ADVISABLE WHEN A SLIDING OPENING IS TO BE USED AND IT IS NOT POSSIBLE TO INSTALL AN INTERNAL WALL BOX. UP TO 4 DOORS CAN BE MOUNTED.

Aperture scorrevoli interno passata senza telaio e per cartongesso

SLIDING OPENINGS INTERIOR WITHOUT FRAME

Binario incassato nel cartongesso

TRACK EMBEDDED IN PLASTERBOARD

Binario con attacco a soffitto

RAIL WITH CEILING CONNECTION

- LINEAIDEA
- STILIDEA
- FIABIDEA
- RESET
- PRESTIGE
- IDEALE
- CONCERTO
- IMAGINE
- SINTESI
- ESSENZA
- LIVING

270^{CM}
h max

X3



X2



Le aperture scorrevoli interno passata possono essere installate anche nella versione senza telaio: indicate per aperture di passaggio molto ampie, trovano la loro massima applicazione come ante di un armadio a muro. I binari possono essere rivestiti con la stessa finitura delle ante oppure incassati nel cartongesso. Possono essere montate fino a 4 ante.

THE INTERNAL PAST SLIDING OPENINGS CAN ALSO BE INSTALLED IN THE FRAMELESS VERSION: INDICATED FOR OPENINGS WITH VERY LARGE WALLS, THEY FIND THEIR MAXIMUM APPLICATION AS DOORS IN A WALL CLOSET. EVEN IN THIS CONFIGURATION IT IS POSSIBLE TO MOUNT UP TO 4 DOORS.

Aperture a doppio battente e sopraluce

DOUBLE DOOR OPENINGS AND FANLIGHT

- LINEAIDEA
- STILIDEA
- FIABIDEA
- RESET
- PRESTIGE
- IDEALE
- CONCERTO
- IMAGINE
- SINTESI
- ESSENZA
- LIVING



Sopraluce

Il sopraluce è lo spazio chiuso da un vetro o da un pannello, anche apribile, posto sopra la porta.

THE TRANSOM WINDOW IS THE SPACE CLOSED BY A GLASS PLACED ABOVE THE DOOR.

Doppio battente

Le porte a doppio battente, come dice il nome, sono composte da due ante che fanno battuta una sull'altra. Queste possono essere di dimensioni uguali (doppio battente simmetrico) oppure di dimensioni differenti (doppio battente asimmetrico). Al doppio battente è possibile abbinare anche un sopraluce.

DOUBLE DOORS, AS THE NAME IMPLIES, ARE COMPOSED OF TWO DOORS THAT ABUT ONE ANOTHER. THESE CAN BE OF EQUAL SIZE (DOUBLE SYMMETRICAL SASH) OR OF DIFFERENT SIZES (DOUBLE ASYMMETRICAL SASH). THE DOUBLE DOOR CAN ALSO BE COMBINED WITH A FANLIGHT.

Armadiature

WARDROBES

- LINEAIDEA
- STILIDEA
- FIABIDEA
- RESET
- PRESTIGE
- IDEALE
- CONCERTO
- IMAGINE
- SINTESI
- ESSENZA
- LIVING



Armadi a muro

È possibile utilizzare ante e telai delle varie collezioni Sololegno per creare dei veri e propri armadi a muro: la stessa finitura e gli stessi telai utilizzati per le altre porte della casa conferiscono una linea armonica e coordinata a tutta la casa.

IT IS POSSIBLE TO USE THE DOORS AND FRAMES OF THE SOLOLEGNO COLLECTIONS TO CREATE REAL BUILT-IN WARDROBES: THE SAME FINISH AND THE SAME FRAMES USED FOR THE OTHER DOORS OF THE HOUSE GIVE A HARMONIOUS AND COORDINATED LINE TO THE WHOLE HOUSE.

 SOLOLEGNO



Maniglie
HANDLES

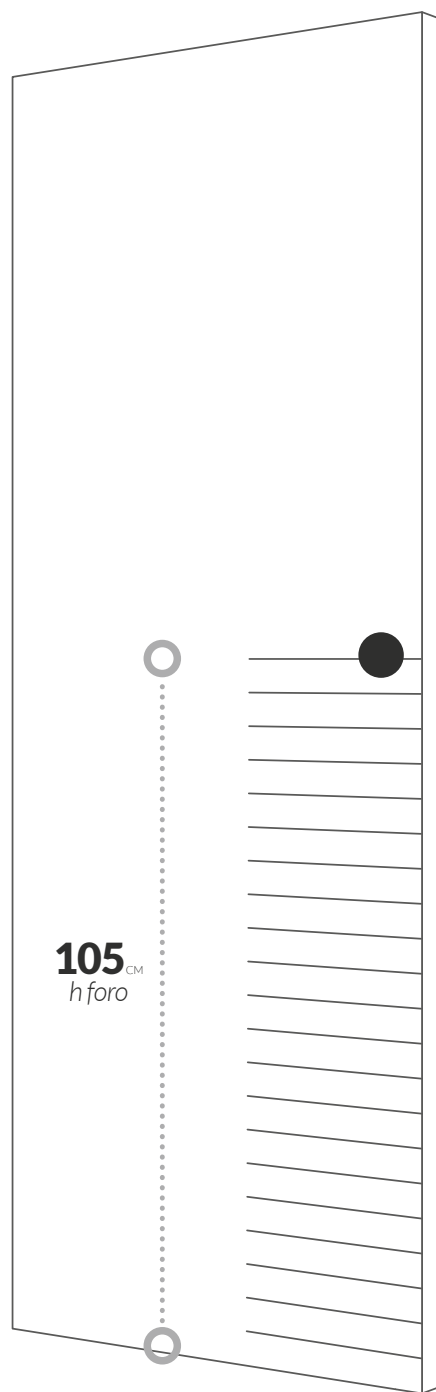

Il foro per la maniglia viene effettuato a 105 cm da terra (ad esclusione delle porte della collezione Living il cui foro viene effettuato a 109,7 cm) e a 5 cm da bordo anta.

THE HOLE FOR THE HANDLE IS MADE AT 105 CM FROM THE FLOOR (WITH THE EXCEPTION OF THE DOORS IN THE LIVING COLLECTION WHOSE HOLE IS MADE AT 109.7 CM) AND AT 5 CM FROM THE EDGE OF THE DOOR.



Maniglia + chiave

MANIGLIA + CHIAVE

La più classica delle combinazioni: la maniglia aziona lo scrocco per l'apertura e la chiusura, la chiave blocca lo scrocco.

THE MOST CLASSIC OF COMBINATIONS: THE HANDLE OPERATES THE LATCH FOR OPENING AND CLOSING, THE KEY LOCKS THE LATCH.

Maniglia + L/O

MANIGLIA + L/O

La versione L/O (libero occupato) è l'evoluzione della chiave, rende esteticamente più gradevole la porta.

THE L/O (FREE OCCUPIED) VERSION IS THE EVOLUTION OF THE KEY, MAKING THE DOOR MORE AESTHETICALLY PLEASING.

Maniglia + cilindro

MANIGLIA + CILINDRO

La possibilità di inserire un cilindro europeo consente un'infinità di applicazioni, dettate dalle numerose varianti e funzioni di questo sistema di chiusura.

THE POSSIBILITY OF INSERTING A EUROPEAN CYLINDER ALLOWS FOR AN INFINITE NUMBER OF APPLICATIONS, DICTATED BY THE NUMEROUS VARIATIONS AND FUNCTIONS OF THIS LOCKING SYSTEM.

Maniglia naked

MANIGLIA NAKED

Versione senza foro chiave: indicata per ante che non devono essere chiuse a chiave e necessitano di soluzioni estetiche "minimaliste".

VERSION WITHOUT KEY HOLE: SUITABLE FOR DOORS THAT DO NOT NEED TO BE LOCKED AND REQUIRE "MINIMALIST" AESTHETIC SOLUTIONS.



Serratura Patent meccanica

MECHANICAL PATENT LOCK

La classica serratura per porte interne: la chiusura "a chiave" è possibile grazie al blocco dello scrocco. È reversibile per porte destre e sinistre.

THE CLASSIC LOCK FOR INTERIOR DOORS: THE CLOSURE "KEY" IS POSSIBLE THANKS TO THE LATCH LOCK. IT IS REVERSIBLE FOR RIGHT AND LEFT DOORS.



Serratura Magnetica

MAGNETIC LOCK

Indicata per porte di design: lo scrocco resta sempre represso, tranne quando si avvicina al telaio e per "attrazione" chiude l'anta. Il blocco dello scrocco consente la "chiusura a chiave".

SUITABLE FOR DESIGNER DOORS: THE LATCH ALWAYS REMAINS RETRACTED, EXCEPT WHEN APPROACHING THE FRAME, FOR "ATTRACTION" IT CLOSES THE DOOR, LOCKING THE LATCH ALLOWS "KEY LOCKING".



Serratura per scorrevoli

LOCK FOR SLIDING DOORS

Serratura pensata e progettata per ante scorrevoli: lo scrocco ad uncino aggancia l'anta al telaio grazie al suo movimento rotatorio.

LOCK DESIGNED FOR SLIDING DOORS: THE HOOK LATCH HOOKS THE DOOR TO THE FRAME THANKS TO ITS ROTARY MOVEMENT.



Maniglie per porte a battente

HANDLES FOR SWING DOORS

Maniglie **tonde**

ROUND HANDLES



Maniglie **Slim**

SLIM HANDLES



Maniglie **Quadre**

SQUARE HANDLES



Tonde, Quadre o Slim? Sono i particolari che fanno la differenza. La stessa maniglia cambia completamente se viene montata con le bocchette tonde, con quelle quadre o nella versione Slim (bocchette minimal). Scegli la soluzione che meglio si adatta alla tua porta: nell'esempio qui a lato puoi notare come la stessa maniglia mod. SOCHI cambi aspetto in base alla versione.

ROUND, SQUARE OR SLIM? THESE ARE THE DETAILS THAT MAKE THE DIFFERENCE. THE SAME HANDLE CHANGES COMPLETELY IF IT IS MOUNTED WITH ROUND VENTS, WITH SQUARE ONES OR IN THE SLIM VERSION (MINIMAL VENTS). CHOOSE THE SOLUTION THAT BEST FITS YOUR DOOR: IN THE EXAMPLE ON THE RIGHT YOU CAN SEE HOW THE SAME HANDLE MOD. SOCHI CHANGES APPEARANCE BASED ON THE VERSION.



La scelta della maniglia è dettata da vari fattori: il design, la leggerezza, l'impugnatura, il colore, la lunghezza, lo spessore... è per questo che le abbiamo dedicato un catalogo a parte. **Più di quaranta modelli** per oltre 600 combinazioni possibili.

THE CHOICE OF THE HANDLE IS DICTATED BY VARIOUS FACTORS: THE DESIGN, THE LIGHTNESS, THE GRIP, THE COLOR, THE LENGTH, THE THICKNESS... THAT'S WHY WE HAVE DEDICATED A SEPARATE CATALOG TO IT, MORE THAN FORTY MODELS FOR OVER 600 POSSIBLE COMBINATIONS.

Maniglie per porte a battente o scorrevoli senza serratura

HANDLES FOR HINGED OR SLIDING DOORS WITHOUT LOCK

IS

INOX SATINATO

IL

INOX LUCIDO

CL

CROMO LUCIDO

CS

CROMO SATINATO

OL

OTTONE LUCIDO

BI

BIANCO

Per porte a battente o scorrevoli senza serratura è possibile utilizzare un'ampia gamma di soluzioni, dalle più minimaliste, alle più originali e curiose.

FOR HINGED OR SLIDING DOORS WITHOUT LOCK IT IS POSSIBLE TO USE A WIDE RANGE OF SOLUTIONS, FROM THE MOST MINIMALIST TO THE MOST ORIGINAL AND CURIOUS.

MAN-T196

MAN-T116

MAN-T66

MAN-T46

MAN-T20-L

MAN-Q20-L

MAN-Q46

MAN-Q66

MAN-Q116

MAN-Q196



KM-MFQ



KM-MFR



KM-ML



PMT



PMQ



Disponibili solo per porte scorrevoli

DISPONIBILI SOLO PER PORTE SCORREVOLI



⚠ KM-MR

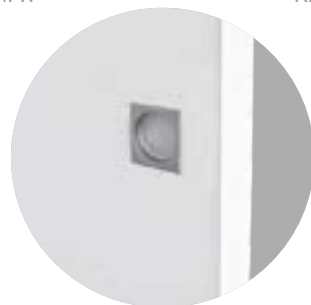

⚠ KM-MQ



⚠ KM-MT



⚠ KM-MO

Maniglie per porte a battente o scorrevoli con serratura

HANDLES FOR HINGED OR SLIDING DOORS WITH LOCK



Per porte scorrevoli FOR SLIDING DOORS



Per porte a battente FOR SWING DOORS

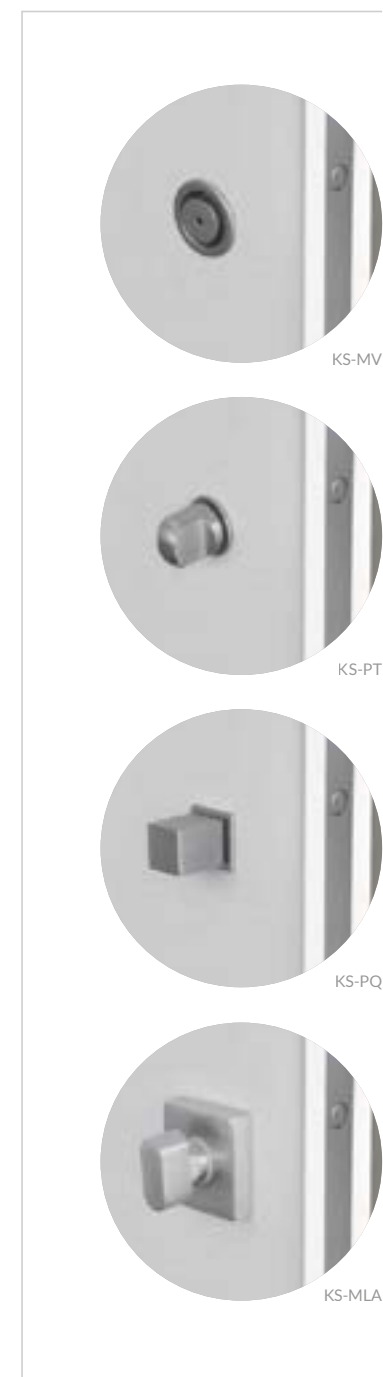

Magneti

MAGNETS

L'utilizzo di piccoli, ma potenti magneti, agevola le operazioni di chiusura delle ante, garantendone l'allineamento nel tempo. Possono essere montati sia su ante mono battente o su ante a doppio battente.

THE USE OF SMALL BUT POWERFUL MAGNETS FACILITATES THE CLOSING OPERATIONS OF THE DOORS, GUARANTEEING THEIR ALIGNMENT OVER TIME. THEY CAN BE MOUNTED EITHER ON THE SINGLE-LEAF DOOR OR ON DOUBLE-LEAF DOORS.

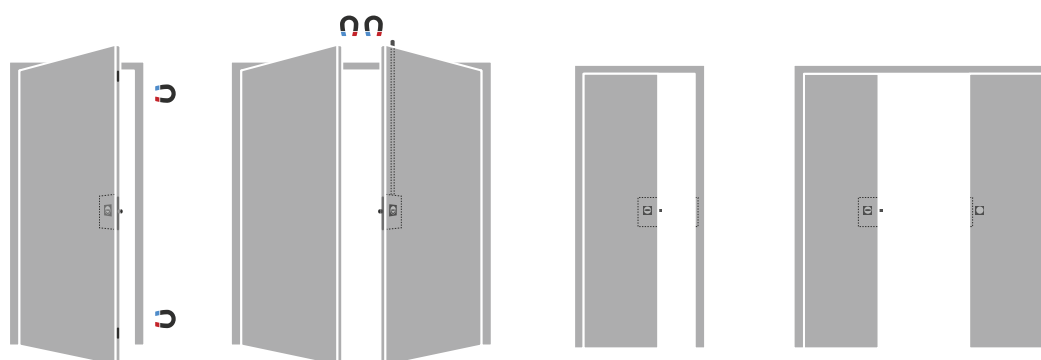

Vetri

GLASS

LP03

RS10

Tutti i vetri sono realizzati nella versione da 6 mm (contraddistinti dalla lettera C iniziale) ad eccezione dei vetri del modello LP03 per cui vengono realizzati in una versione da 8 mm (contraddistinto dalla lettera iniziale D)

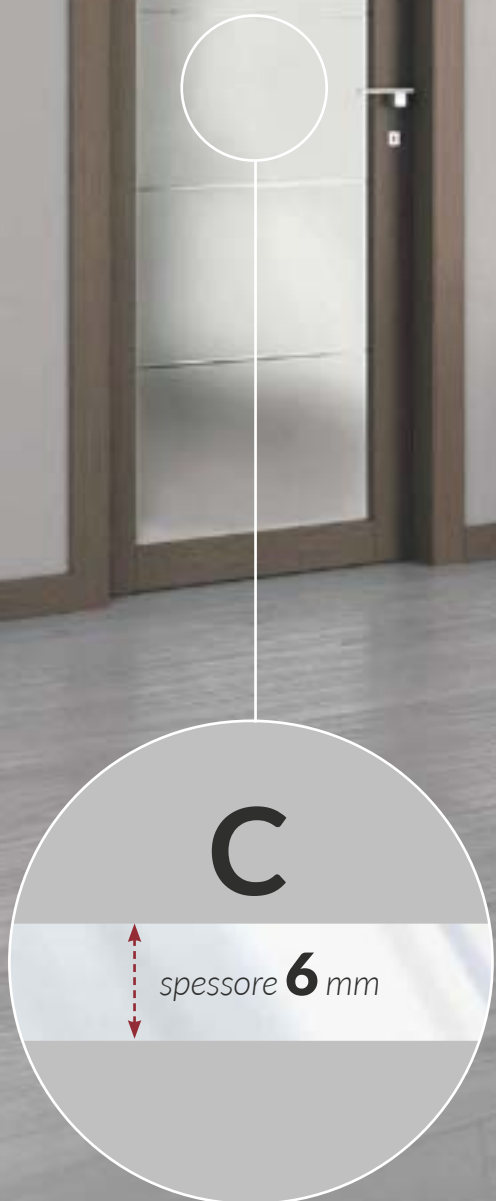

ALL GLASSES ARE MADE IN THE 6 MM VERSION (MARKED WITH THE INITIAL LETTER C) WITH THE EXCEPTION OF THE GLASSES OF THE LP03 MODEL FOR WHICH THEY ARE MADE IN AN 8 MM VERSION (MARKED BY THE INITIAL LETTER D)

Vetri trasparenti

TRANSPARENT GLASS



Trasparente **FLOAT**
GLASS TRANSPARENT FLOAT



Trasparente **EXTRACHIARO**
GLASS TRANSPARENT EXTRACLEAR



Trasparente **GRIGIO**
GLASS TRANSPARENT GREY



Trasparente **BRONZO**
GLASS TRANSPARENT BRONZE

Vetri satinati

FROSTED GLASS



Satinato **FLOAT**
FLOAT FROSTED



Satinato **EXTRACHIARO**
EXTRACLEAR FROSTED



Satinato **GRIGIO**
GREY FROSTED



Satinato **BRONZO**
BRONZE FROSTED

Vetri Temprati *satinati incisi*

Engraved satin-etched glasses



C2-A • C3-A



C2-B • C3-B



C2-C • C3-C



C2-D • C3-D



C2-E • C3-E



C2-H • C3-H



C2-K • C3-K



C2-L • C3-L



C2-P • C3-P



C2-R • C3-R



C2-S • C3-S



C2-T • C3-T



C2-U • C3-U



C2-W • C3-W



C2-Z • C3-Z



C2-FF • C3-FF



C2-F2 • C3-F2



C2-F4 • C3-F4



C2-F7 • C3-F7



C2-FA • C3-FA



C2-FC • C3-FC



C4-C • C5-C



C17-A



C17-B



C17-C



C17-D



C17-E



C17-F



C17-G



C2-X/C4-X

incisioni LUCIDE
BRIGHT ENGRAVED INCISIONS



C3-X/C5-X

incisioni OPACHE
OPAQUE ENGRAVED INCISIONS



C17-X

incisioni PIATTE LUCIDE
POLISHED FLAT INCISIONS



C17-H



C17-I



C17-L



C17-M



C17-N



C17-O



C17-P



C17-Q



C17-R



C17-S

V E T R I

Vetri Temprati *satinati sabbiati*

Crystals tempered satinated glasses



C16-A



C16-G



C16-H



C16-E



C16-R



C16-P



C16-Q



C16-O



C16-S



C16-T



C16-U



C16-J



C16-K



C16-V



C16-W



C16-X



C16-Y



C16-Z



C16-AA



C16-AB



C16-AC



C16-AD



C16-AE



C16-AF



C16-AG



C16-AH



C16-AI



C16-AL



C16-AM



C16-AN

AIP s.r.l. - Divisione SOLOLEGNO

Via Soleabò n. 20 - 12032 BARGE (CN) IT
Tel. +39 0175 343225 - Fax +39 0175 343503

www.aipporte.com

Certificazioni

AIP s.r.l. progetta e realizza tutti i suoi prodotti in osservanza al sistema di gestione della qualità secondo le normative prescritte dalla UNI EN ISO 9001:2008.

AIP s.r.l. designs and manufactures all of its products in accordance with the system of quality management according to the standards prescribed by the UNI EN ISO 9001:2015.



Tutti i modelli delle porte sono frutto della creatività del centro Design della AIP Divisione SOLOLEGNO.

All models of the doors are the result of the creativity of the design center of the AIP Division SOLOLEGNO

Le finiture ed i colori illustrati nel presente catalogo sono da considerarsi puramente indicativi; inoltre AIP s.r.l. si riserva, anche senza preavviso, di apportare ai prodotti lievi modifiche e/o migliorie tecniche ed estetiche.

The finishes and colors shown in this catalog are purely indicative; also AIP s.r.l. reserves the right, without notice, to make minor changes to the products and / or technical and aesthetic improvements.

Stampa e produzione

L'ARTISTICA Savigliano
Via Palmiro Togliatti, 44, 12038 Savigliano (CN)

OTTOBRE 2019

www.aipporte.com
info@aipporte.com

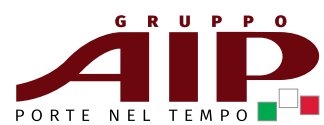

AIP s.r.l.

Via Soleabò, 20 - 12032 San Martino Barge (Cn) - Italia
Tel. 0175.343225 - Fax 0175.343503

