

CRISTALDESIGN
VISIONI 

GRUPPO
AIP
PORTE NEL TEMPO 

CRISTALDESIGN
VISIONI 



Scansiona il QR Code presente nelle prossime pagine per accedere a contenuti extra.
Scan the QR Code on the following pages to access additional content.



DESTINAZIONI SORPRENDENTI

Le novità di questo catalogo8



IL VETRO IN MOVIMENTO

Tutti i sistemi di apertura22



IL VETRO OLTRE I SUOI CONFINI

Interazioni del vetro con altri materiali 106



IL VETRO ED I COLORI

Tutte le cromie e lavorazioni disponibili 130



L'INCONTRO DI DUE MONDI

Modelli coordinati con altre collezioni 162



IL VETRO NELLA SUA ESSENZA

Sezione tecnica riepilogativa 176



IL NOSTRO PIANETA

Visioni trasforma il vetro in porte e strutture, crea un legame con il nostro mondo, combinando produzione di qualità e design moderno per creare uno spazio nuovo in ogni casa.

Visioni transforms glass into doors and structures, creates a link with our world, combining quality production and modern design to create a new space in every home.





PORTE E STRUTTURE IN VETRO, VISIONI D'ITALIA

L'arte e la creatività italiane di Visionsi, il brand di porte e strutture in vetro: ogni pezzo è un'opera d'arte, un'emanazione di stile e qualità Made in Italy, che trasforma gli ambienti con raffinatezza.

The Italian art and creativity of Visionsi, the brand of glass doors and structures: each piece is a work of art, an emanation of Made in Italy style and quality, which transforms environments with refinement.



DESTINAZIONI SORPRENDENTI

Viaggia nel futuro delle porte in vetro con le nostre ultime creazioni.

Innovazione, design d'avanguardia e funzionalità si fondono in un mondo di possibilità senza limiti.

Travel into the future of glass door art with our latest creations. Innovation, cutting-edge design and functionality come together in a world of limitless possibilities.



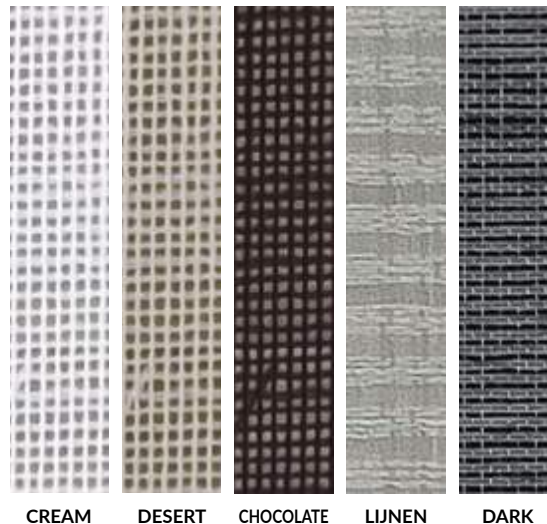

CANVAS intreccio tra vetro, tessuto e alluminio

La stoffa all'interno del vetro, per personalizzare le proprie porte con un design unico ed originale. Cinque trame e colori differenti, abbinare ad un vetro extrachiaro, capace di adattarsi ad un design ricercato ed unico.

CANVAS INTERWEAVING OF GLASS, FABRIC AND ALUMINIUM

The fabric inside the glass, to personalize your doors with a unique and original design. Five different textures and colours, combined with extra-clear glass, capable of adapting to a refined and unique design.



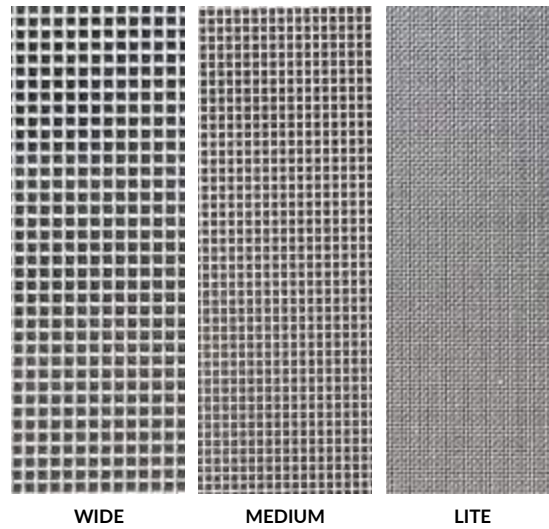

CONNECTION

una rete
di riflessi per
un vetro unico

La serie di vetri "Connection" ha un cuore d'acciaio. Tre reti metalliche con trame differenti, accoppiate ad un vetro extrachiaro, grigio o bronzo, conferiscono alla porta un tocco personale dal design moderno e delicato.

AN INTERCONNECTED NETWORK
IN TRANSPARENCY, A UNIQUE GLASS

The "Connection" glass series has a heart of steel. Three metal meshes with different textures, coupled with extra-clear, gray or bronze glass, give the door a personal touch with a modern and delicate design.



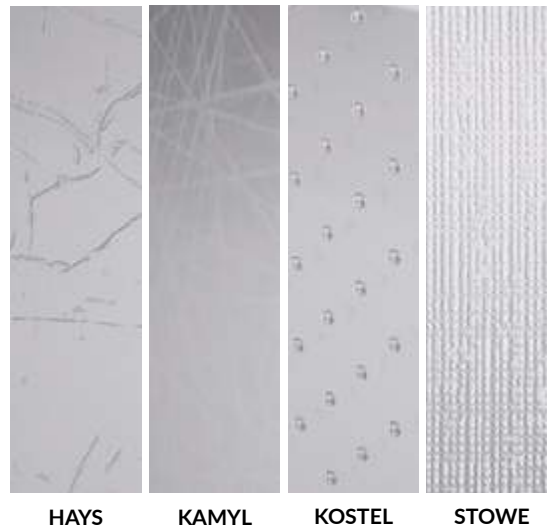

MATERICI l'impronta della materia impressa nel vetro

Una texture appena percepibile,
delle linee fitte ed irregolari,
tanti piccoli puntini simmetrici,
un rilievo geometrico su fondo satinato:
vetri unici, adatti per chi vuole
discrezione senza rinunciare alla luce.

THE IMPRINT OF THE MATERIAL IMPRINTED IN THE GLASS

*A barely perceptible texture, thick and irregular lines, many
small symmetrical dots, a geometric relief on a satin
background: unique glass, suitable for those who want
discretion without giving up light.*





WOOD il legno ridisegnato dal vetro

Porte in vetro eleganti con profili in alluminio e inserti in legno: l'armonia di materiali nobili e modernità, un connubio di stile e funzionalità per ogni ambiente.

THE WOOD REDESIGNED FROM GLASS

Elegant glass doors with aluminum profiles and wooden inserts: the harmony of noble materials and modernity, a combination of style and functionality for every environment.





PROFILE il profilo nella versione a battente

Porte in vetro, profili in alluminio
sottili come l'eleganza.
Trasparenza e design si fondono in
un'incredibile leggerezza, donando
luce e modernità ai tuoi spazi."

THE PROFILE IN THE SWING VERSION

*Glass doors, aluminum profiles as thin as elegance.
Transparency and design come together in an incredible
lightness, giving light and modernity to your spaces."*



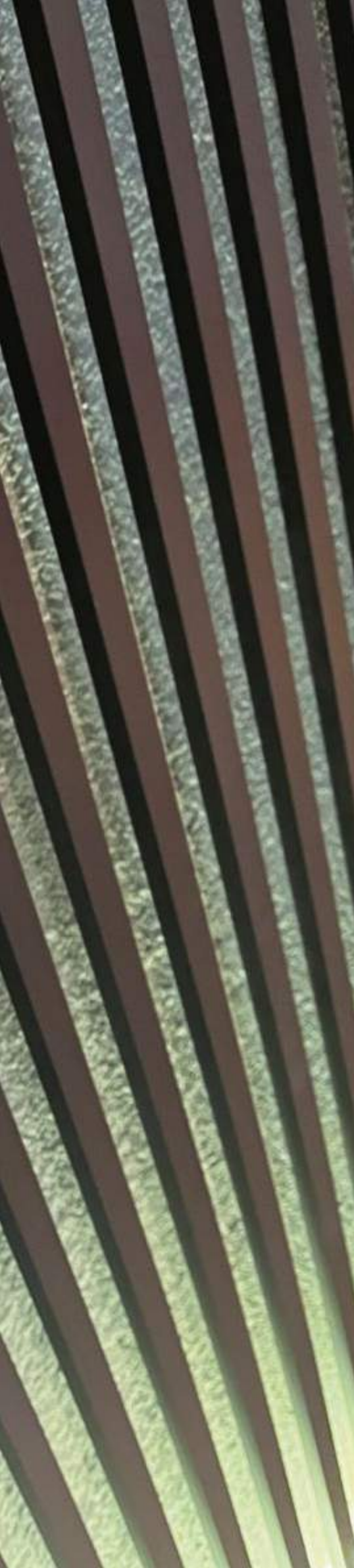

INDUSTRIAL alluminio, vetro e affascinanti geometrie

Porte in vetro con profili in alluminio a quadri di ispirazione urbana: la fusione tra modernità e design dà vita ad interni dall'aspetto distintivo.

ALUMINIUM, GLASS AND FASCINATING GEOMETRIES

Glass doors with urban-inspired checked aluminum profiles: the fusion between modernity and design gives life to interiors with a distinctive look.

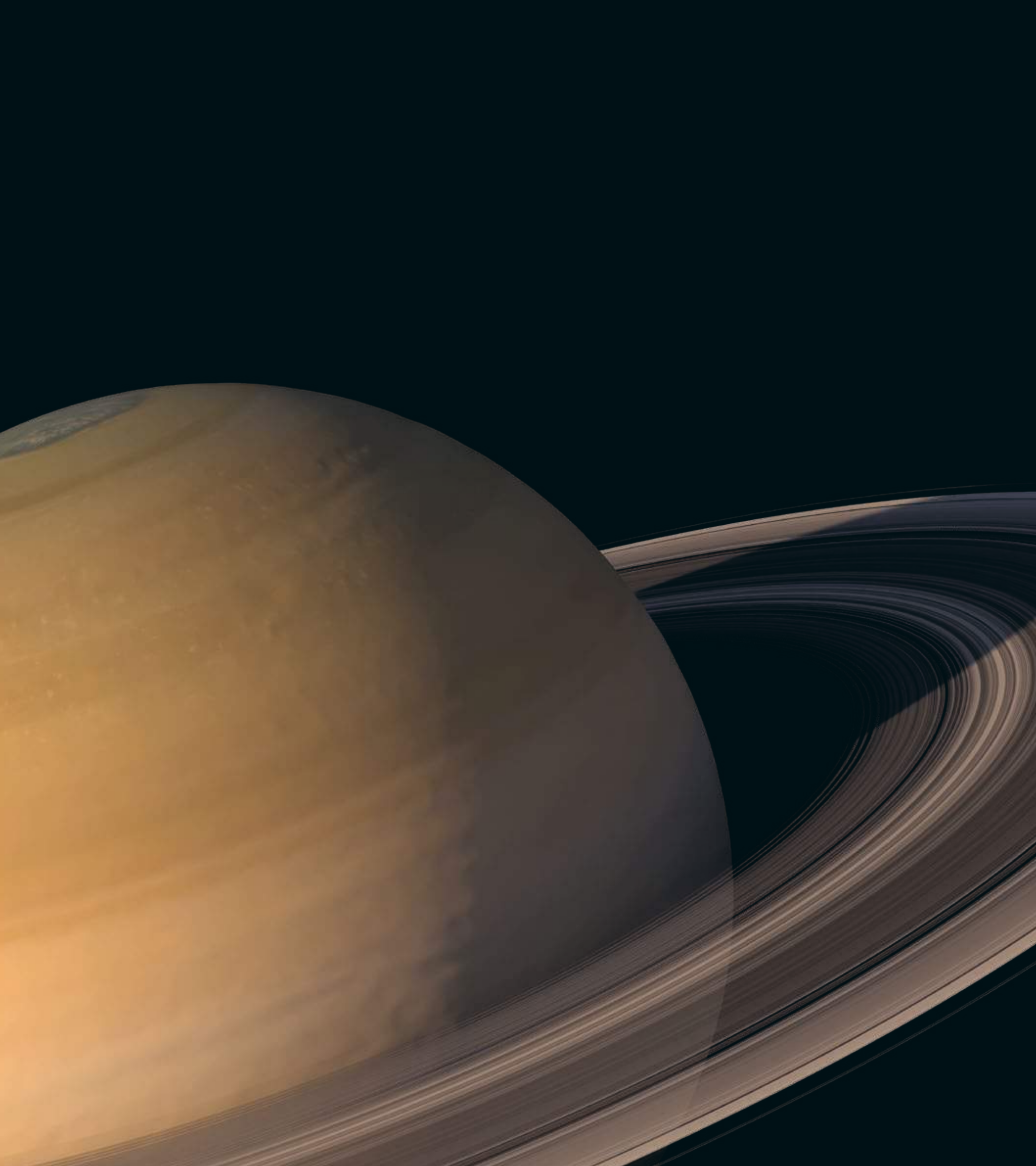



IL VETRO IN MOVIMENTO

Esplora un mondo di possibilità
con le nostre porte in vetro:
dalle scorrevoli interne ed esterne
alle soluzioni più classiche,
apri le porte alla tua creatività.

*Explore a world of possibilities with our glass doors:
from internal and external sliding doors to more classic
solutions, open the doors to your creativity.*

MAESTRO:
il sistema di scorrimento
esterno per porte in vetro
che unisce l'eleganza
minimale del design al
binario silenzioso
ed affidabile.

MAESTRO:
*the external sliding
system for glass doors
that combines the
minimal elegance of the
design with the silent
and reliable track.*



MAESTRO VISIONI

SCORREVOLE ESTERNO MURO

Visioni

Porta scorrevole esterno muro
Vetro trasparente bronzo
Sistema di scorrimento **Maestro**
Maniglione MAN-T46

Visioni

*Sliding door external wall
Bronze transparent glass
Maestro flow system
MAN-T46 pull handle*





Visioni
Porta doppia scorrevole
opposta esterno muro
Vetro trasparente extrachiaro
Sistema di scorrimento **Maestro**
Maniglione MAN-Q46 alluminio

Visioni
Double sliding door opposite external wall
Extra-clear transparent glass
Maestro sliding system
MAN-Q46 aluminum pull handle

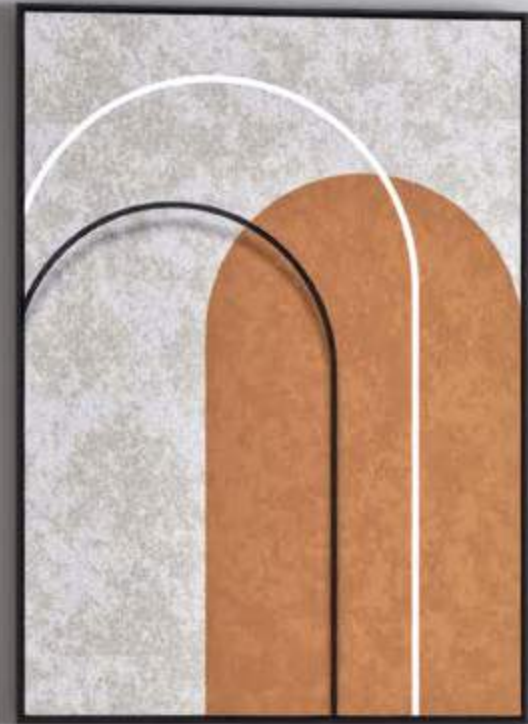



Visioni

Porta scorrevole esterno muro
su anta fissa
Vetro satinato bronzo
Sistema di scorrimento **Maestro**

Visioni

External wall sliding door
on fixed leaf
Bronze satin glass
Maestro sliding system



SCORREVOLE ESTERNO MURO MAESTRO

Finiture disponibili



Caratteristiche tecniche

Portata massima 110 Kg/anta
Larghezza minima foro muro 400 mm
Lunghezza massima binario 6000 mm
Ammortizzato (con limitazioni)

Technical features

Maximum load 110 Kg/leaf
Minimum wall opening width 400 mm
Maximum track width 6000 mm
Amortized (with limitations)

Principali versioni disponibili Main versions available

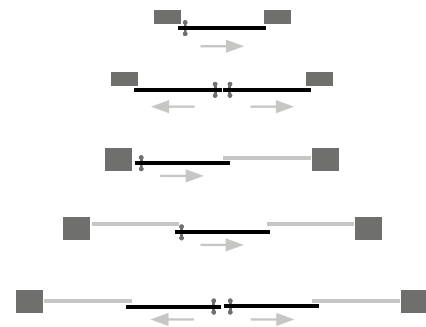

Passaggio chiuso

Passage closed

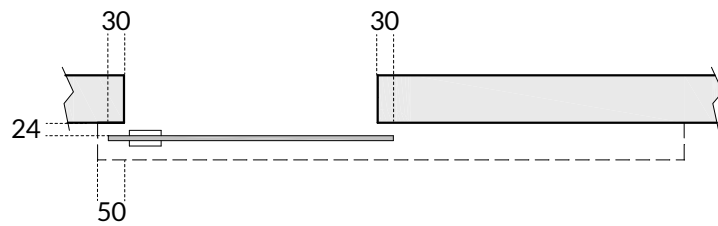

sormonto anta sul muro 30 mm per lato
distanza anta dal muro 24 mm

door overlap on the wall 30 mm on each side
door distance from the wall 24 mm

Apertura totale

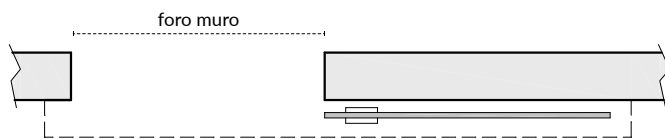

Apertura parziale

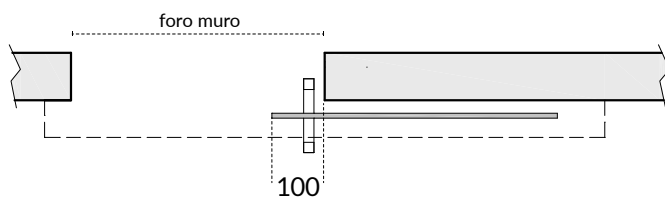

Fissaggio binario a parete

Track fixing to the wall

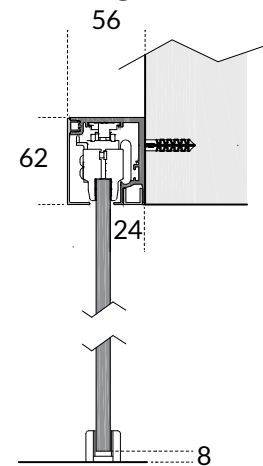

Fissaggio binario a soffitto

Ceiling track fixing

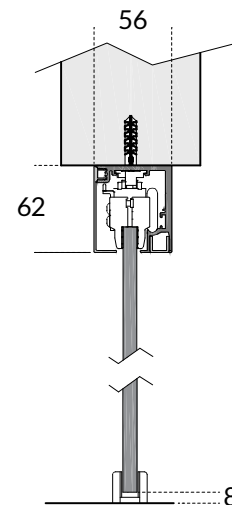

Per ulteriori informazioni tecniche consulta la scheda tecnica sul listino - For further technical information consult the technical data sheet on the price list





ESSENZA:
il minimalismo
raggiunge
l'eccellenza: una
sottile fessura svela
l'armoniosa fusione
tra differenti spazi
interni.

*ESSENZA:
the minimalism
achieves excellence:
a thin crack reveals
the harmonious fusion
between different
interior spaces.*

ESSENZA VISIONI

SCORREVOLE ESTERNO MURO

Visioni

Porta scorrevole esterno muro
Vetro trasparente grigio
Sistema di scorrimento **Essenza**
Maniglione MAN-T46 inox satinato

Visioni

*External wall sliding door
Gray transparent glass
Sliding system **Essenza**
MAN-T46 satin stainless steel pull handle*



Visioni
Porta doppia scorrevole interno
passata su ante fisse
Vetro trasparente grigio
Sistema di scorrimento **Essenza**
Maniglione MAN-T66 inox satinato

Visioni
*Internal sliding double
door on fixed leaves
Gray transparent glass
Sliding system Essenza
MAN-T66 satin stainless steel pull handle*





Visioni

Porta doppia scorrevole opposta esterno muro
Vetro reflex satinato grigio
Sistema di scorrimento **Essenza**
Maniglia VAS-Q

Visioni

Double sliding door opposite external wall
Gray satin reflex glass
Sliding system **Essenza**
VAS-Q handle



SCORREVOLE ESTERNO MURO **ESSENZA**

Finiture disponibili

ANN
ALLUMINIO ANODIZZATO



Caratteristiche tecniche

Portata massima 75 Kg/anta
Larghezza minima foro muro 500 mm
Lunghezza massima binario 6000 mm
Ammortizzato (con limitazioni)

Technical features

Maximum load 75 Kg/leaf
Minimum wall opening width 500 mm
Maximum track width 6000 mm
Amortized (with limitations)

Versioni disponibili Versions available

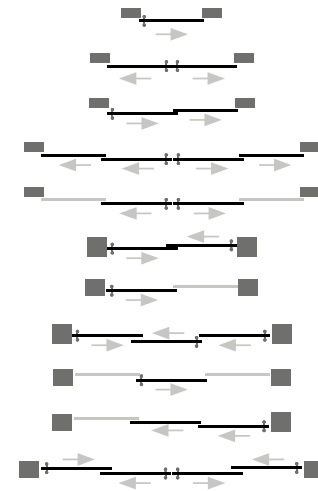

Passaggio chiuso

Passage closed

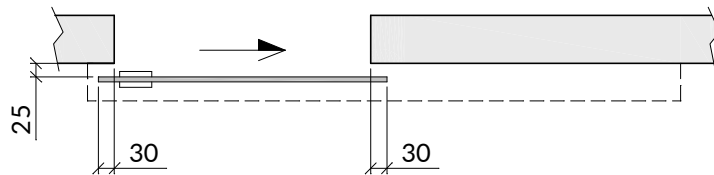

sormonto anta sul muro 30 mm per lato
distanza anta dal muro 25 mm

door overlap on the wall 30 mm on each side
door distance from the wall 25 mm

Apertura totale

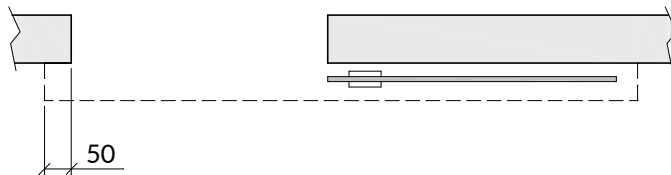

Apertura parziale

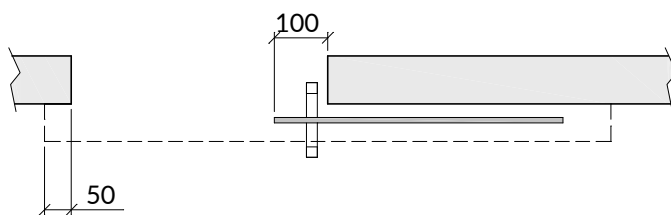

Fissaggio binario a parete

Track fixing to the wall

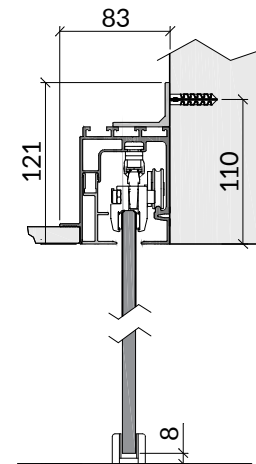

Fissaggio binario a soffitto

Ceiling track fixing

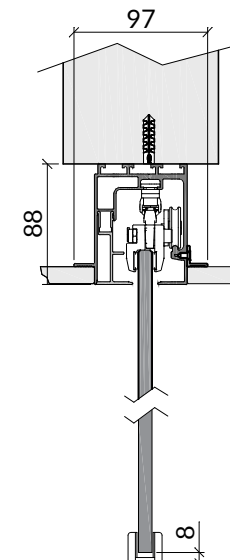

Per ulteriori informazioni tecniche consulta la scheda tecnica sul listino - For further technical information consult the technical data sheet on the price list

LUNA SOFT CLOSE:
il design incontra la
funzionalità Le porte
in vetro scorrono
senza sforzo su un
sistema esterno
leggero e dal design
semplice, creando un
ambiente raffinato

*LUNA SOFT CLOSE:
the design meets
functionality Glass
doors slide effortlessly
over a lightweight,
simply designed exterior
system, creating a
refined environment*



LUNA SOFT CLOSE

VISIONI

SCORREVOLE ESTERNO MURO

Visioni

Porta doppia scorrevole opposta
Vetro Neutral extrachiaro
Sistema di scorrimento **Luna soft close**
Maniglia VAS-T

Visioni

*Opposite double sliding door
Neutral extra-clear glass
Luna soft close slider system
VAS-T handle*

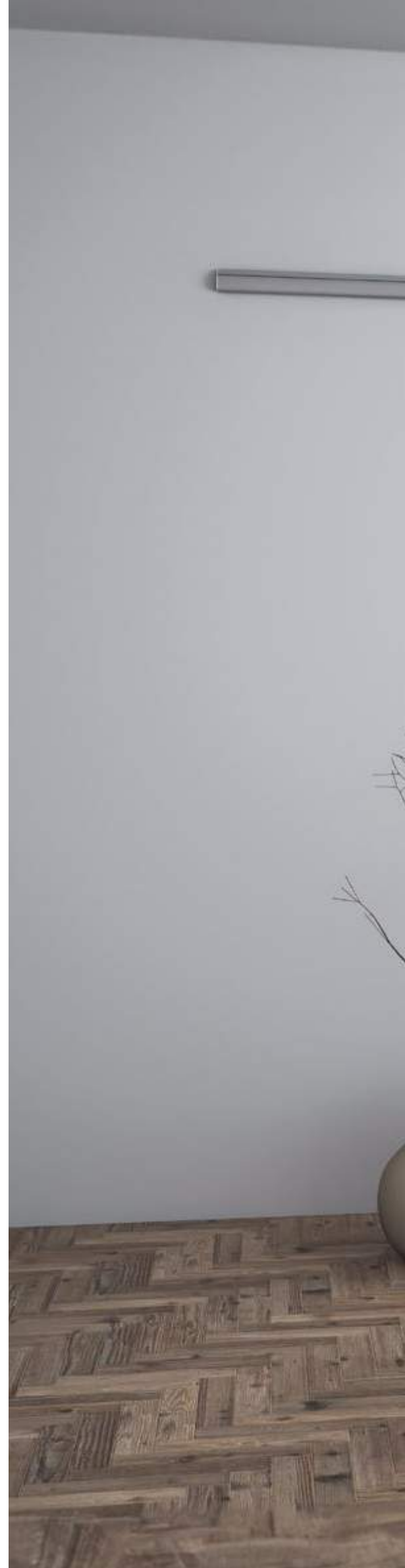



Visioni
Porta scorrevole esterno muro
Vetro satinato extrachiaro
Sistema di scorrimento **Luna soft close**

Visioni
External wall sliding door
Extra-clear satin glass
Luna soft close slider system



SCORREVOLE ESTERNO MURO LUNA SOFT CLOSE

Finiture disponibili

IS
INOX
SATINATO



Caratteristiche tecniche

Portata massima 70 Kg/anta
Larghezza minima foro muro 400 mm
Lunghezza massima binario 6000 mm
Ammortizzato

Technical features

Maximum load 70 Kg/leaf
Minimum wall opening width 400 mm
Maximum track width 6000 mm
Amortized

Versioni disponibili

Versions available

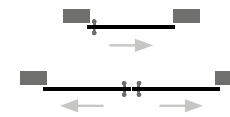

Passaggio chiuso

Passage closed

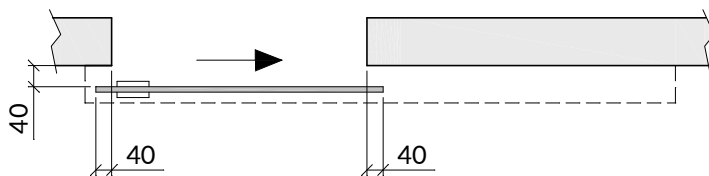

sormonto anta sul muro 40 mm per lato
distanza anta dal muro 40 mm

door overlap on the wall 40 mm on each side
door distance from the wall 40 mm

Apertura totale

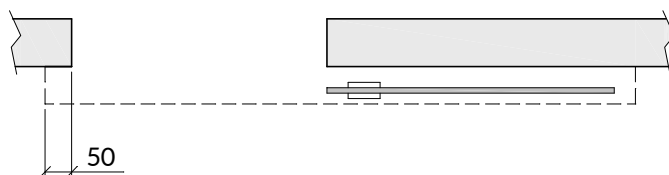

Apertura parziale

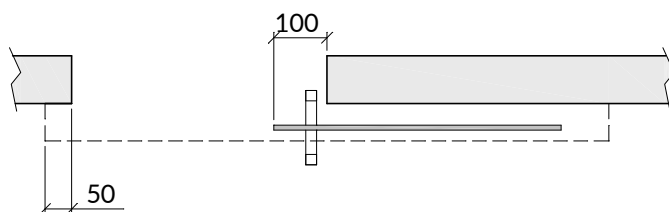

Fissaggio binario a parete

Track fixing to the wall

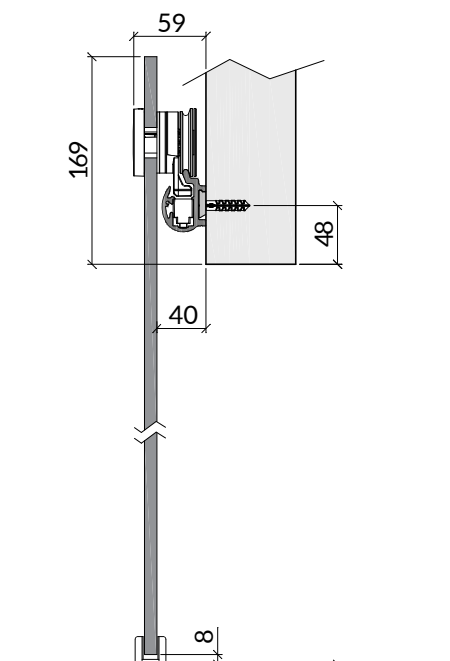





PURO SOFT CLOSE:
la sintesi di stile e
tecnologia.
Le porte in vetro si
muovono fluidamente
grazie all'aggancio
preciso sulla rotaia,
garantendo un design
puro e moderno

*PURO SOFT CLOSE:
the synthesis of style
and technology.
The glass doors move
fluidly thanks to the
precise attachment to
the track, guaranteeing a
pure and modern design*

PURO SOFT CLOSE

VISIONI

SCORREVOLE ESTERNO MURO

Visioni

Porta scorrevole esterno muro
Vetro reflex trasparente grigio
Sistema di scorrimento **Puro soft close**
Maniglione MAN-T46

Visioni

*Sliding door external wall
Gray transparent reflex glass
Puro soft close flow system
MAN-T46 pull handle*





SCORREVOLE ESTERNO MURO PURO SOFT CLOSE

Finiture disponibili

IS
INOX
SATINATO



Caratteristiche tecniche

Portata massima 70 Kg/anta
Larghezza minima foro muro 400 mm
Lunghezza massima binario 6000 mm
Ammortizzato

Technical features

Maximum load 70 Kg/leaf
Minimum wall opening width 400 mm
Maximum track width 6000 mm
Amortized

Versioni disponibili Versions available

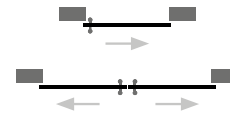

Passaggio chiuso

Passage closed

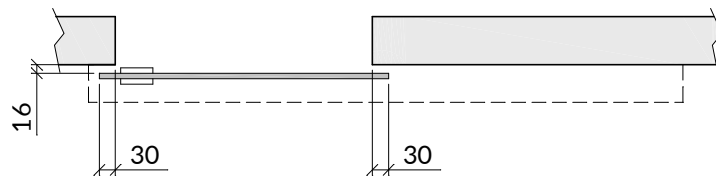

sormonto anta sul muro 30 mm per lato
distanza anta dal muro 16 mm

door overlap on the wall 30 mm on each side
door distance from the wall 16 mm

Apertura totale

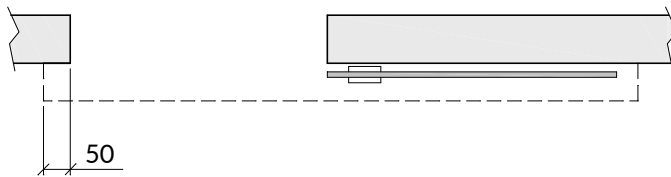

Apertura parziale

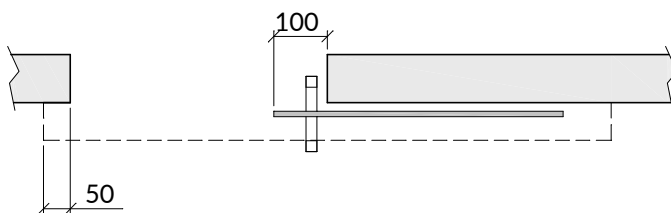

Fissaggio binario a parete

Track fixing to the wall

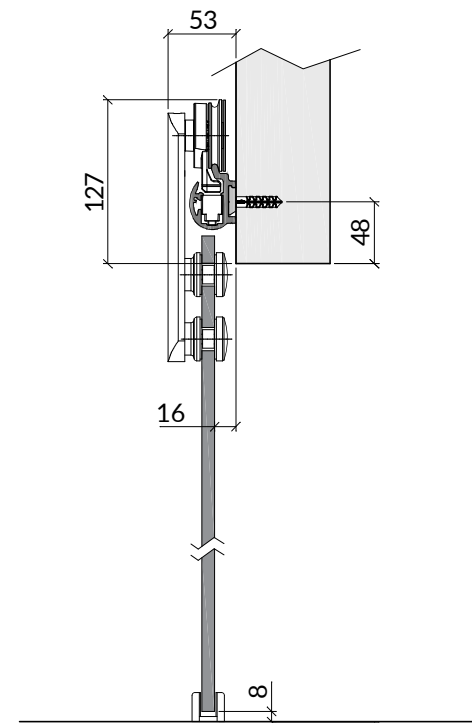

Per ulteriori informazioni tecniche consulta la scheda tecnica sul listino - For further technical information consult the technical data sheet on the price list

EVASIONE:
la scelta ideale per
chi fugge la banalità
e per gli amanti della
linearità e dell'estetica
impeccabile: ambienti
diversi si integrano in
modo armonioso

EVASIONE:
*the ideal choice for those
who seek to escape banality
and for lovers of linearity
and impeccable aesthetics:
diverse environments
seamlessly integrate in a
harmonious manner*



EVASIONE VISIONI

SCORREVOLE ESTERNO MURO

Visioni

Porta scorrevole esterno muro
Vetro reflex trasparente bronzo
Sistema di scorrimento **Evasione**
Maniglia MAN-Q20

Visioni

*External wall sliding door
Bronze transparent reflex glass
Scroll system Evasione
MAN-Q20 handle*







SCORREVOLE ESTERNO MURO **EVASIONE**

Finiture disponibili



Caratteristiche tecniche

Portata massima 70 Kg/anta
Larghezza minima foro muro 500 mm
Lunghezza massima binario 1300 mm
Ammortizzato

Technical features

Maximum load 70 Kg/leaf
Minimum wall opening width 500 mm
Maximum track width 1300 mm
Amortized

Versioni disponibili
Versions available

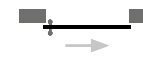

Passaggio chiuso Passage closed

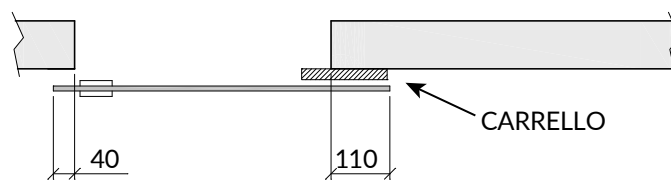

Apertura massima

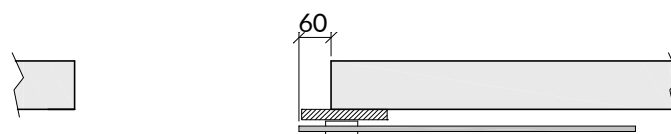

Apertura parziale

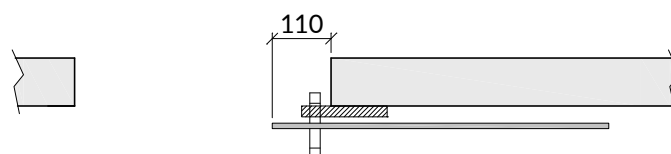

Fissaggio binario a parete Track fixing to the wall

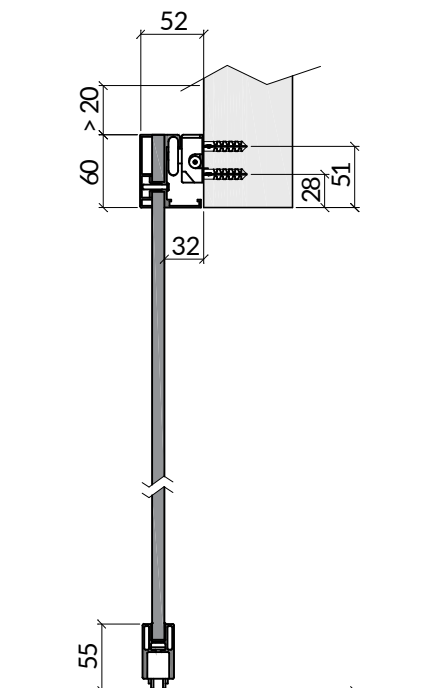

Per ulteriori informazioni tecniche consulta la scheda tecnica sul listino - For further technical information consult the technical data sheet on the price list





CUBO FLUID:
grazie al sistema di
scorrimento esterno
muro si uniscono la
solidità dell'ingegneria
e la bellezza del
design, per spazi
eleganti e funzionali

*CUBO FLUID:
thanks to the external
wall sliding system,
the solidity of the
engineering and the
beauty of the design
combine for elegant
and functional spaces*

CUBO FLUID

VISIONI

SCORREVOLE ESTERNO MURO

Visioni
Porta scorrevole esterno muro
Vetro trasparente grigio
Sistema di scorrimento **Cubo Fluid**
Maniglione MAN-Q46

Visioni
*External wall sliding door
Gray transparent glass
Cubo Fluid sliding system
MAN-Q46 pull handle*





SCORREVOLE ESTERNO MURO CUBO FLUID

Finiture disponibili

ANN
ALLUMINIO
ANODIZZATO

VN
VERNICIATO
NERO



Caratteristiche tecniche

Portata massima 75 Kg/anta
Larghezza minima foro muro 500 mm
Lunghezza massima binario 6000 mm
Ammortizzato

Technical features

Maximum load 75 Kg/leaf
Minimum wall opening width 500 mm
Maximum track width 6000 mm
Amortized

Versioni disponibili Versions available

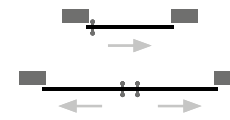

Passaggio chiuso Passage closed

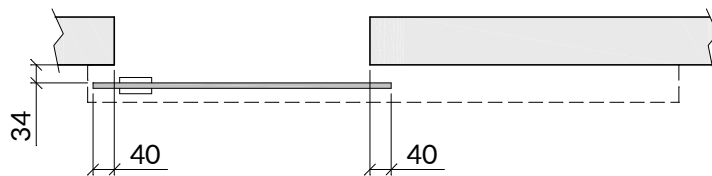

sormonto anta sul muro 40 mm per lato
distanza anta dal muro 34 mm

door overlap on the wall 40 mm on each side
door distance from the wall 34 mm

Apertura totale

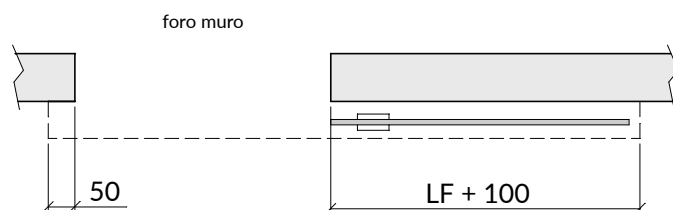

Apertura parziale

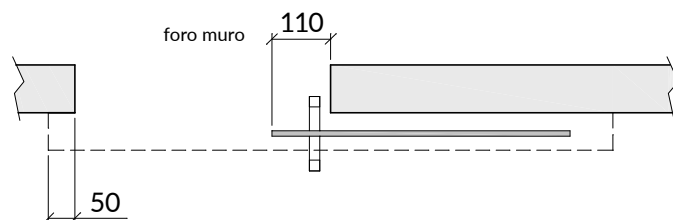

Fissaggio binario a parete Track fixing to the wall

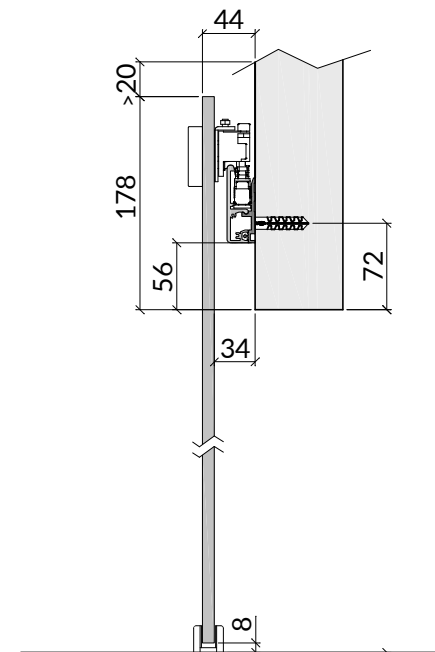

MINERVA:
l'eleganza e la
funzionalità unite in
una porta scorrevole
interna, per un design
senza compromessi
e un'esperienza di
apertura fluida

MINERVA:
*elegance and functionality
combined in an internal
sliding door, for an
uncompromising design
and a fluid opening
experience*



MINERVA VISIONI

SCORREVOLE INTERNO MURO
SENZA TELAIO

Visioni

Porta scorrevole interno muro
Vetro trasparente dark
Maniglia VAS-TS

Visioni

Internal wall sliding door
Transparent dark glass
VAS-TS handle









PARIDE:
l'equilibrio perfetto tra
design e robustezza
La nostra porta
scorrevole interna
con telaio offre stile
e affidabilità senza
paragoni

*PARIDE:
the perfect balance
between design and
robustness Our internal
sliding door with frame
offers unmatched style
and reliability*

PARIDE VISIONI

SCORREVOLE INTERNO MURO
CON TELAIO

Visioni
Porta scorrevole interno muro
Vetro Hays grigio

Visioni
*Internal sliding door
Hays gray glass*



SCORREVOLE INTERNO MURO SENZA TELAIO **MINERVA**

Finiture disponibili

ANN

ALLUMINIO ANODIZZATO

VBI

VERNICIATO BIANCO

VN

VERNICIATO NERO

VS

VERNICIATO COL SPECCHIO



Caratteristiche tecniche

Portata massima 120 Kg/anta

Larghezza minima di passaggio 400 mm

Technical features

Maximum load 120 Kg/leaf

Minimum passage width 400 mm

Versioni disponibili

Versions available

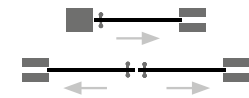

Passaggio chiuso

Passage closed

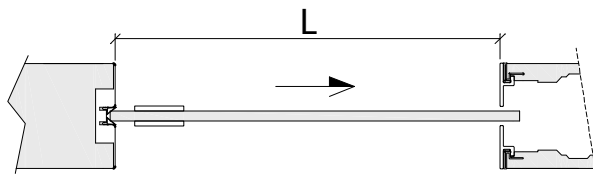

Apertura totale

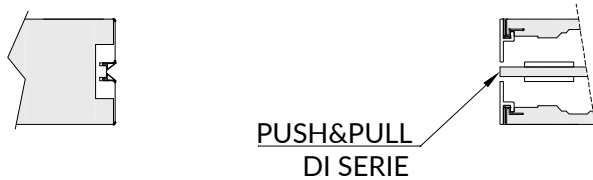

Apertura parziale



Sezione verticale

Vertical section

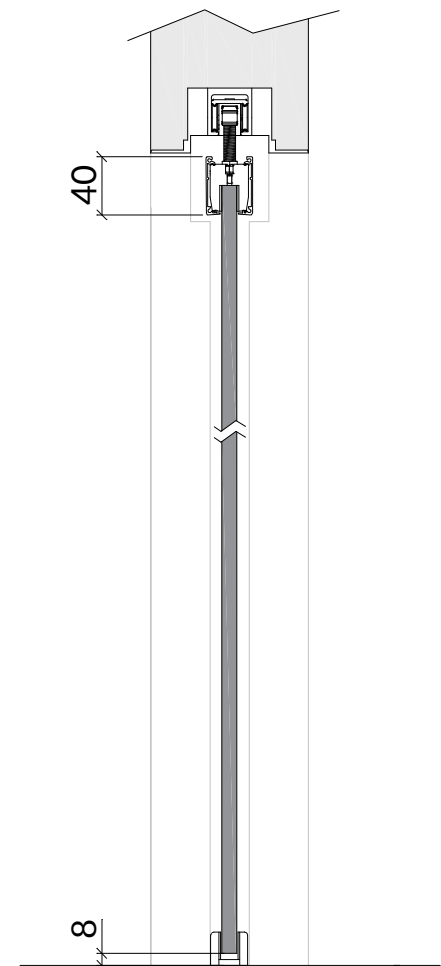

Per ulteriori informazioni tecniche consulta la scheda tecnica sul listino - For further technical information consult the technical data sheet on the price list

SCORREVOLE INTERNO MURO CON TELAIO **PARIDE**



Caratteristiche tecniche

Portata massima 120 Kg/anta

Larghezza minima di passaggio 400 mm

Technical features

Maximum load 120 Kg/leaf

Minimum passage width 400 mm

Versioni disponibili

Versions available

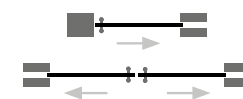

Passaggio chiuso

Passage closed

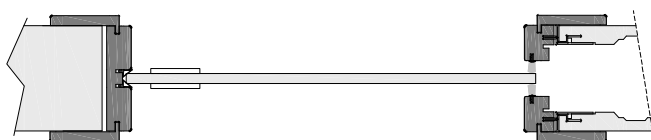

Apertura totale

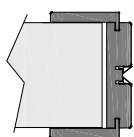

PUSH&PULL
DI SERIE

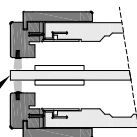

Apertura parziale

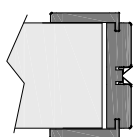

STOP
DI SERIE

80

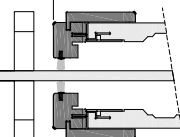

Sezione verticale

Vertical section

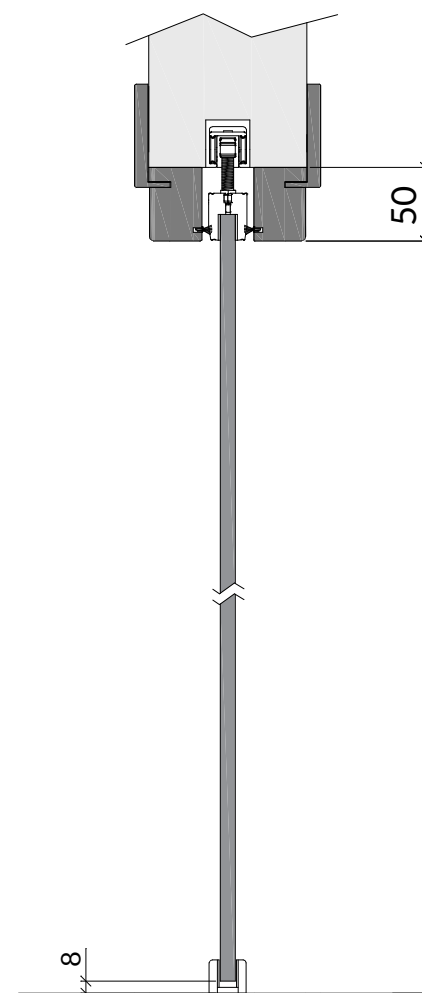



EVO

EVO1

ARYS:
la porta in vetro va
e viene che coniuga
trasparenza e praticità
Soluzione versatile per
un passaggio alternato
in ogni ambiente

ARYS:
*the back and forth glass
door that combines
transparency and
practicality Versatile
solution for alternating
passage in any
environment*



ARYS VISIONI

P O R T A A V E N T O L A

Visioni

Porta a ventola con cerniera EVO
Vetro satinato grigio
Maniglione MAN-Q30 inox satinato

Visioni

*Fan door with EVO zip
Gray satin glass
MAN-Q30 satin stainless steel pull handle*









NEMESI:
una porta
in vetro che sfida le
convenzioni conferisce
eleganza audace e
apertura inusuale
a ogni ambiente

NEMESI:
*a pivot glass door that
challenges conventions it
gives bold elegance and
unusual openness to
any environment*

NEMESI VISIONI

PORTA A BILICO PIVOT

Visioni

Porta a pivot
Vetro trasparente grigio
Sistema di apertura bilico pavimento soffitto
Maniglione MAN-Q30 inox satinato

Visioni

*Pivot door
Gray transparent glass
Floor-to-ceiling pivot opening system
MAN-Q30 satin stainless steel pull handle*



PORTA A VENTOLA **ARYS**



Arys con cerniere EVO a scatto

Caratteristiche tecniche
 Portata massima 65 Kg/anta
 Tipologia chiusura: Libera
 Apertura massima +90°/-90°
 Larghezza massima di passaggio 900 mm

Technical features
 Maximum load 65 Kg/leaf
 Closure type: Free
 Maximum opening +90°/-90°
 Maximum passage width 900 mm

Finiture disponibili

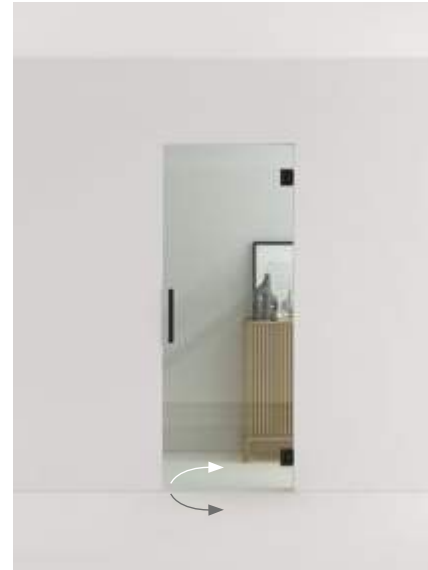

Arys con cerniere EVO1 oleodinamiche

Caratteristiche tecniche
 Portata massima 100 Kg/anta
 Tipologia chiusura: oleodinamiche
 Apertura massima +90°/-90°
 Larghezza massima di passaggio 1000 mm

Technical features
 Maximum load 100 Kg/leaf
 Closure type: Free
 Maximum opening +90°/-90°
 Maximum passage width 900 mm

Finiture disponibili



Per ulteriori informazioni tecniche consulta la scheda tecnica sul listino - For further technical information consult the technical data sheet on the price list

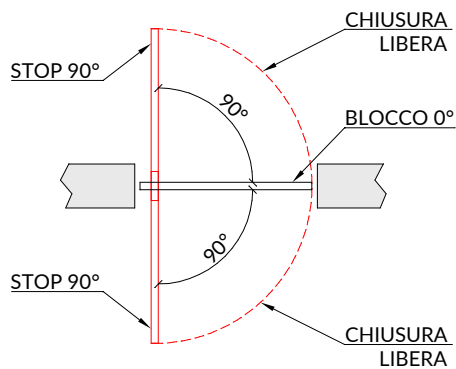

Versioni disponibili

Versions available

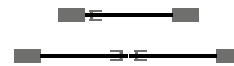

Arys muro a vista

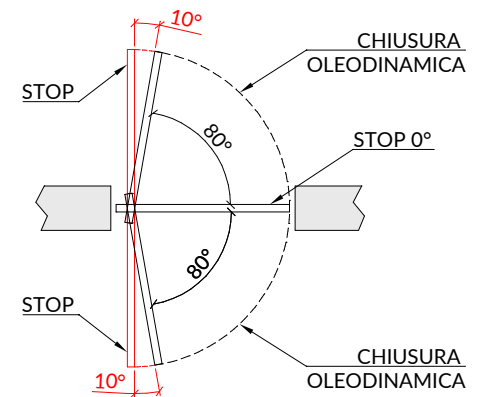

Porta a ventola con muro a vista

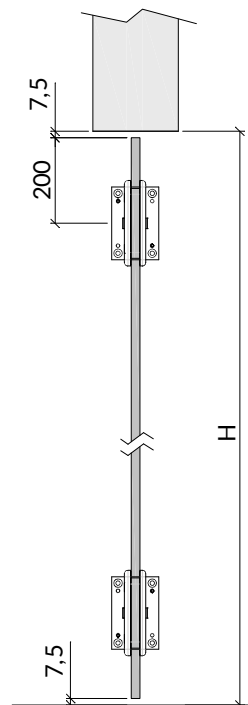
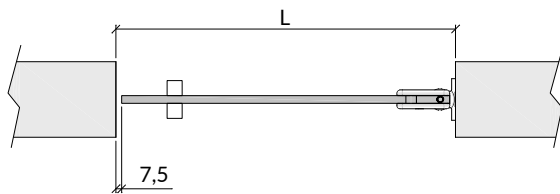

PORTA A BILICO PIVOT **NEMESI**



**Nemesi con
cerniere pivot
decentrate**

Caratteristiche tecniche

Portata massima 100 Kg/anta
 Tipologia chiusura: Oleodinamica
 Apertura massima +90°/-90°
 Larghezza massima di passaggio 1000 mm
 Larghezza massima vetro 1600 mm

Technical features

Maximum load 100 Kg/leaf
 Closure type: Oleodinamic
 Maximum opening +90°/-90°
 Maximum passage width 1000 mm
 Maximum glass width 1600 mm

Finiture
disponibili



**Nemesi con
cerniere pivot
a filo anta**

Caratteristiche tecniche

Portata massima 100 Kg/anta
 Tipologia chiusura: Oleodinamica
 Apertura massima +90°/-90°
 Larghezza massima di passaggio 1000 mm
 Larghezza massima vetro 1000 mm

Technical features

Maximum load 100 Kg/leaf
 Closure type: Oleodinamic
 Maximum opening +90°/-90°
 Maximum passage width 1000 mm
 Maximum glass width 1000 mm

Finiture
disponibili

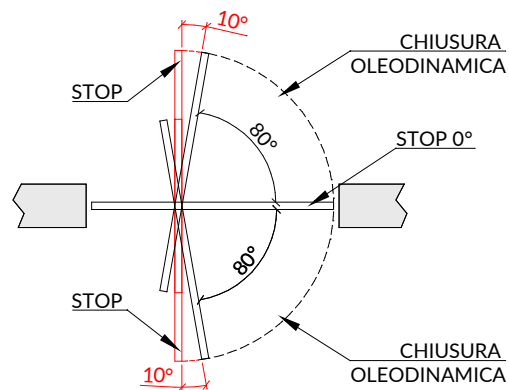

Versioni disponibili Versions available

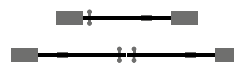

Nemesi muro a vista

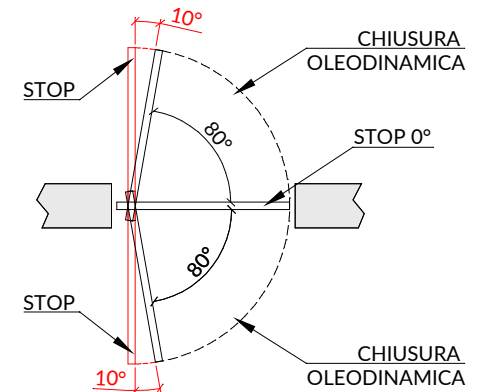
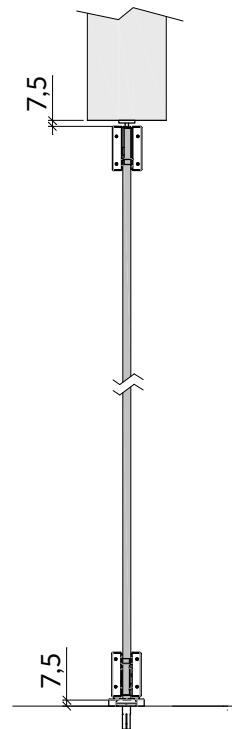

Porta a bilico con muro a vista

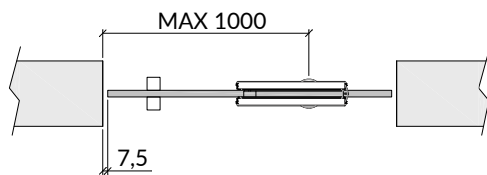

Porta a bilico con muro a vista

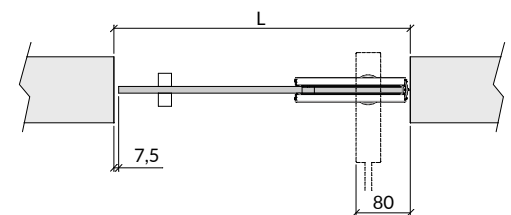



STYLE:
la porta a battente che
definisce l'eleganza
Unisce design
contemporaneo, qualità
e funzionalità per
un'entrata all'insegna
della modernità

STYLE:
*the swing door that
defines elegance It
combines contemporary
design, quality and
functionality for a
modern entrance*



STYLE VISIONI

P O R T A A B A T T E N T E



Visioni
Porta a battente Style
Vetro satinato grigio
Maniglia M

Visioni
*Style swing door
Gray satin glass
M handle*







ATHENA:
la porta in vetro a battente
con cerniere che offre
eleganza e resistenza, per
un ingresso raffinato ed
esclusivo

ATHENA:
*the swing glass door with
hinges that offers elegance
and resistance, for a refined
and exclusive entrance*

ATHENA

VISIONI

PORTA A BATTENTE

Visioni
Porta a battente Athena
Vetro trasparente extrachiaro
Maniglia ATM

Visioni
*Swing door Athena
Extra-clear transparent glass
ATM handle*



PORTA A BATTENTE **STYLE**

Finiture disponibili



Caratteristiche tecniche

Portata massima 60 Kg/anta
 Altezza massima foro muro 2700 mm
 Larghezza massima 900 mm

Technical features

Maximum load 60 Kg/leaf
 Maximum wall opening height 2700 mm
 Maximum width 900 mm

Versioni disponibili
Versions available

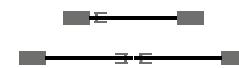

Telai disponibili vedi pag 70
Available frames see page 70

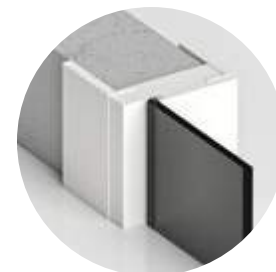

Per ulteriori informazioni tecniche consulta la scheda tecnica sul listino - For further technical information consult the technical data sheet on the price list

Porta a battente Style con telaio in legno
Passage closed

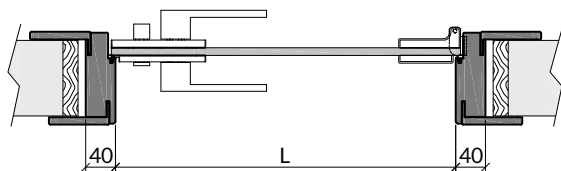

Porta a battente Style con telaio raso muro

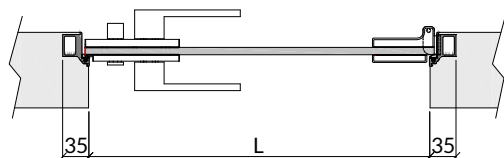

Porta a battente Style con telaio in alluminio

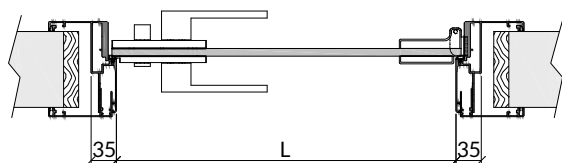

Style con telaio in legno

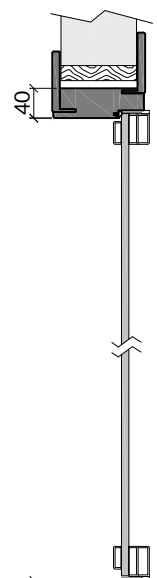

Style con telaio raso muro

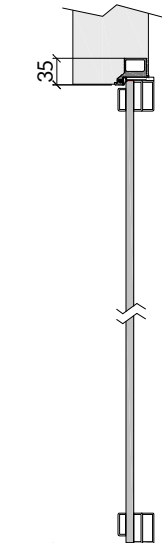

Style con telaio in alluminio

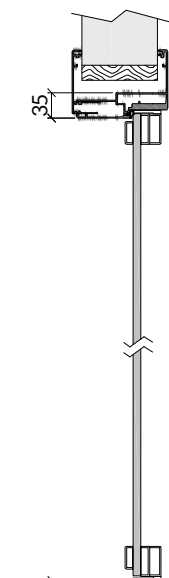

PORTA A BATTENTE **ATHENA**

Finiture disponibili

ANN

ALLUMINIO ANODIZZATO

GBK

ALLUMINIO ANODIZ. NERO



Caratteristiche tecniche

Portata massima 60 Kg/anta
Altezza massima foro muro 2700 mm
Larghezza massima 900 mm

Technical features

Maximum load 60 Kg/leaf
Maximum wall opening height 2700 mm
Maximum width 900 mm

Versioni disponibili
Versions available

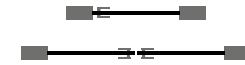

Telai disponibili vedi pag 70
Available frames see page 70

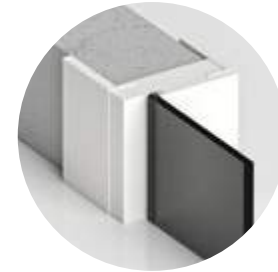

Porta a battente Athena con telaio in legno
Passage closed

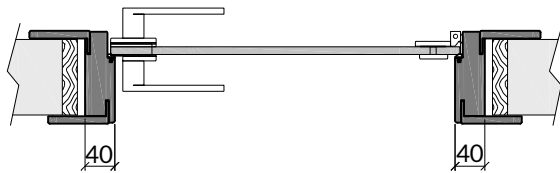

Athena con telaio in legno

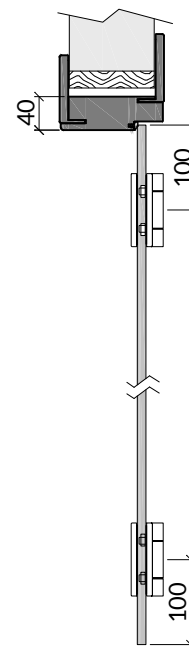

Athena con telaio raso muro

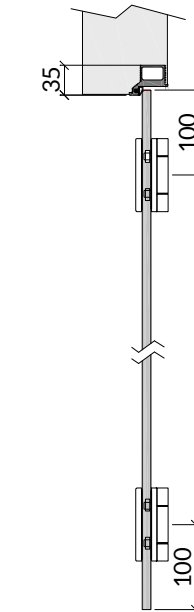

Athena con telaio in alluminio

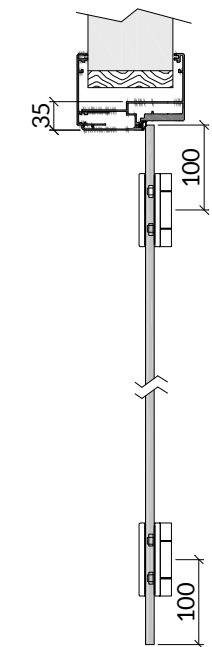

Porta a battente Athena con telaio raso muro

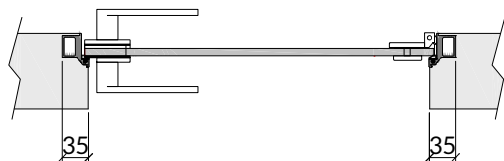

Porta a battente Athena con telaio in alluminio

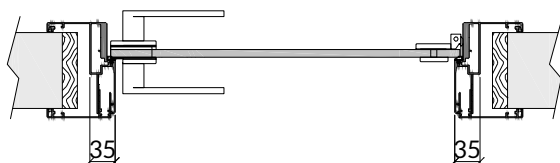

TELAI **BATTENTI** per porte *Visioni*

 **Telaio TN**
in legno/wood

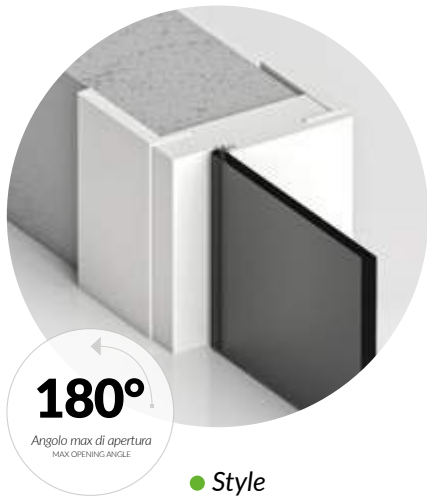

 **Telaio TS**
in legno/wood



 **Telaio TSP**
in legno/wood

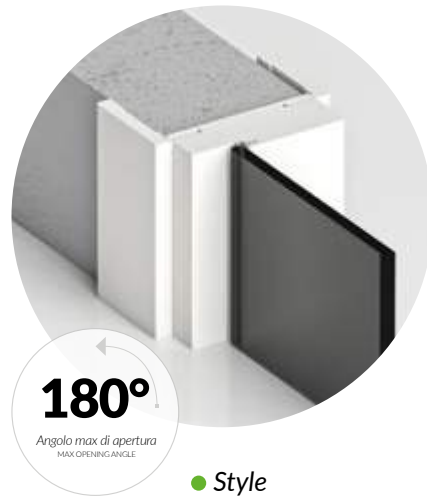

 **Telaio TX**
in legno/wood

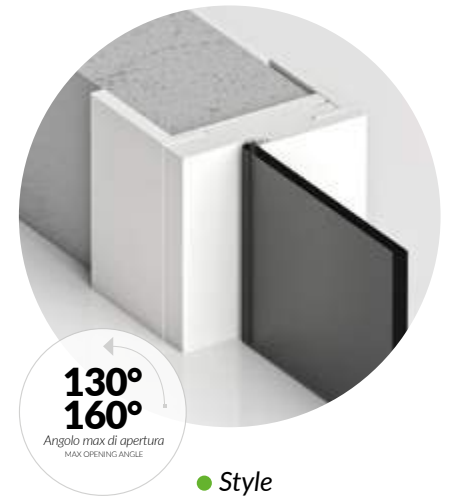

 **Telaio TXS**
in legno/wood



 **Telaio TA**
in alluminio/aluminium



 **Telaio RSN**
rasomuro/close to the wall

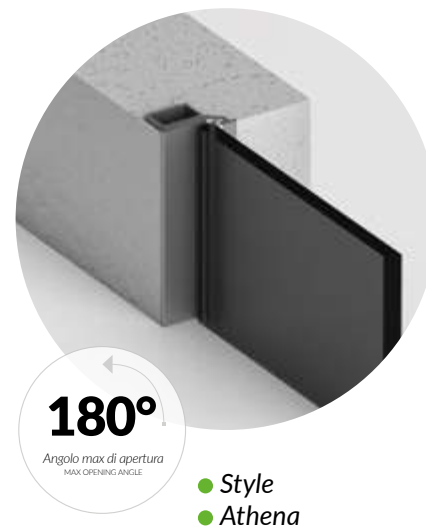

Tipologie di **APERTURA** per porte *Visioni*



p.24

Scorrevole esterno muro **Maestro**



p.30

Scorrevole esterno muro **Essenza**



p.36

Scorrevole esterno muro **Luna soft close**



p.40

Scorrevole esterno muro **Puro soft close**



p.44

Scorrevole esterno muro **Evasione**



p.48

Scorrevole esterno muro **Cubo Fluid**



p.52

Scorrevole interno muro **Minerva**



p.54

Scorrevole interno muro **Paride**



p.58

Porta a ventola **Arys**



p.60

Porta bilico pivot **Nemesi**



p.64

Porta a battente **Style**



p.66

Porta a battente **Athena**

VELO:
l'eleganza in
movimento scorrevole
esterno muro, questa
porta in vetro con
profili unisce design
moderno e funzionalità
senza compromessi

VELO:
*elegance in movement
Sliding external wall,
this glass door with
profiles combines
modern design and
uncompromising
functionality*



VELO

VISIONI PROFILE

SCORREVOLE ESTERNO MURO

Visioni Profile

Porta scorrevole esterno muro con profili grafite
Vetro trasparente grigio
Sistema di scorrimento **VELO**
Maniglione MAN-PR28

Visioni Profile

External wall Sliding door with graphite profiles
Gray transparent glass
Velo sliding system
MAN-PR28 pull handle







Visioni Profile
Porte scorrevoli opposte
interno passata
Vetro trasparente bronzo
con profili sohara
Sistema di scorrimento
Velo a soffitto
Maniglione MAN-PR28

Visioni Profile
*Opposite sliding doors
internal pass
Bronze transparent glass
with sohara profiles
Velo ceiling sliding system
MAN-PR28 pull handle*



Visioni Profile
Porta doppia scorrevole
in luce su anta fissa
Vetro trasparente extrachiario
con profili bianchi
Sistema di scorrimento
Velo a soffitto
Maniglione MAN-PR28

Visioni Profile
*Opening double sliding
door on fixed leaf
Extra clear glass
with white profiles
Velo ceiling sliding system
MAN-PR28 pull handle*



SCORREVOLE ESTERNO MURO VELO

Finiture disponibili



Caratteristiche tecniche

Portata massima 100 Kg/anta
 Altezza massima foro muro 3000 mm
 Larghezza minima anta 400 mm
 Larghezza massima binario 6000 mm
 Ammortizzato (con limitazioni)

Technical features

Maximum load 100 Kg/leaf
 Maximum wall opening height 3000 mm
 Minimum door width 400 mm
 Maximum track width 6000 mm
 Amortized (with limitations)

Versioni disponibili Versions available

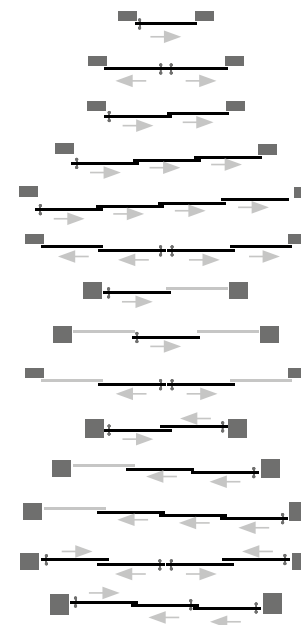

Per ulteriori informazioni tecniche consulta la scheda tecnica sul listino - For further technical information consult the technical data sheet on the price list

Passaggio chiuso Passage closed

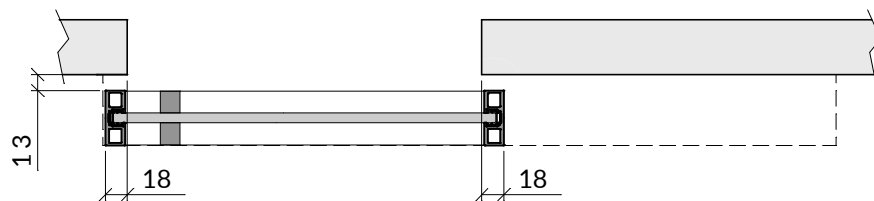

sormonto anta sul muro 18 mm per lato
 distanza anta dal muro 13 mm

door overlap on the wall 18 mm on each side
 door distance from the wall 13 mm

Apertura massima

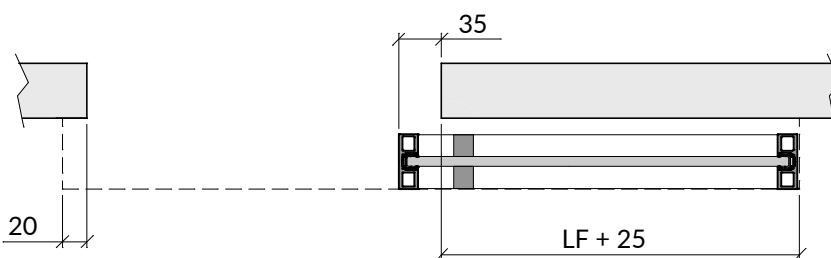

Fissaggio binario a soffitto Ceiling track fixing

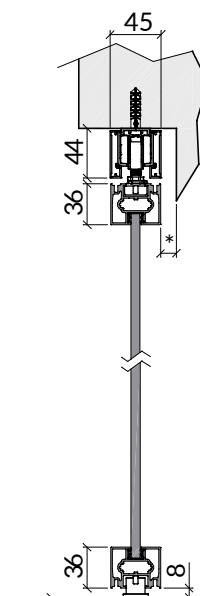

FISSAGGIO A SOFFITTO (VLO-S)

Fissaggio binario a parete Track fixing to the wall

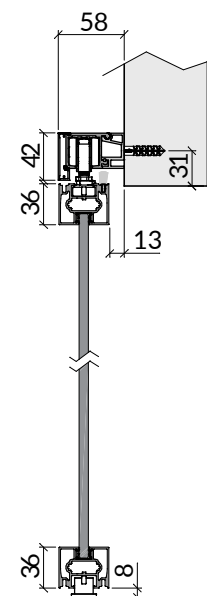

FISSAGGIO A PARETE (VLO)

Profili anta

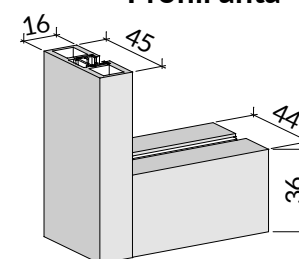





NEXUS
crea uno spazio
senza interruzioni:
porte in vetro che
scorrono in modo fluido
a filo con il soffitto

*NEXUS
create a seamless
space: glass doors
which slide fluidly
flush with the ceiling*

NEXUS VISIONI PROFILE

SCORREVOLE ESTERNO MURO

Visioni Profile
Porta doppia scorrevole opposta esterno muro
Vetro trasparente extrachiario con profilo bianco
Sistema di scorrimento **Nexus**
Maniglia MAN-PR28

Visioni Profile
*Double sliding door opposite external wall
Extra clear glass with white profile
Nexus scroll system
MAN-PR28 handle*



SCORREVOLE ESTERNO MURO NEXUS

Finiture disponibili



Caratteristiche tecniche

Portata massima 100 Kg/anta
 Altezza massima foro muro 3000 mm
 Larghezza minima anta 400 mm
 lunghezza massima binario 6000 mm
 Ammortizzato

Technical features

Maximum load 100 Kg/leaf
 Maximum wall opening height 3000 mm
 Minimum door width 400 mm
 Maximum track length 6000 mm
 Amortized

Versioni disponibili Versions available

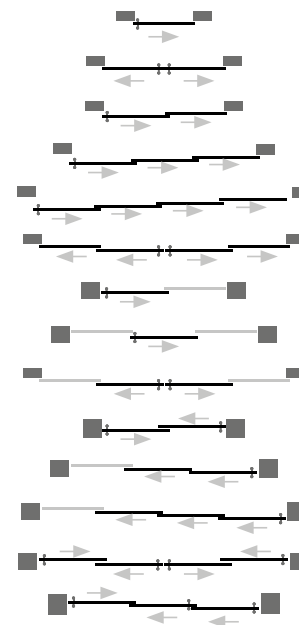

Passaggio chiuso Passage closed

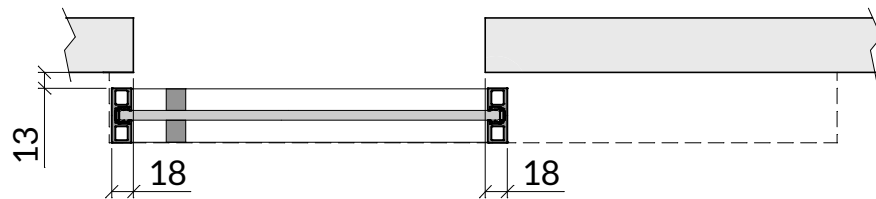

sormonto anta sul muro 18 mm per lato
 distanza anta dal muro 13 mm

door overlap on the wall 18 mm for side
 door distance from the wall 13 mm

Apertura massima

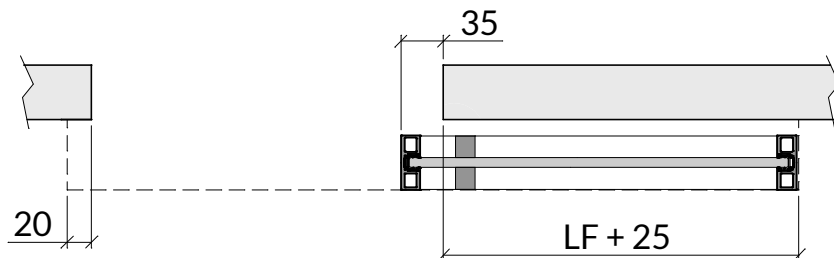

calcolo larghezza binario
 larghezza foro muro x 2 + 25 mm

track width calculation
 wall opening width x 2 + 25 mm

Fissaggio binario a soffitto Ceiling track fixing

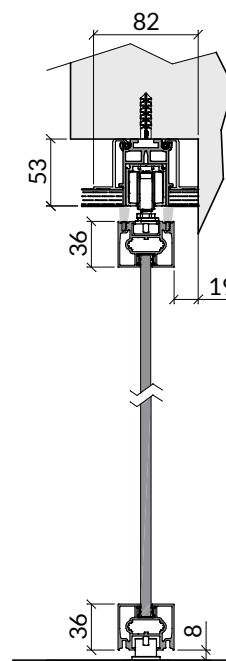

Fissaggio binario a parete Track fixing to the wall

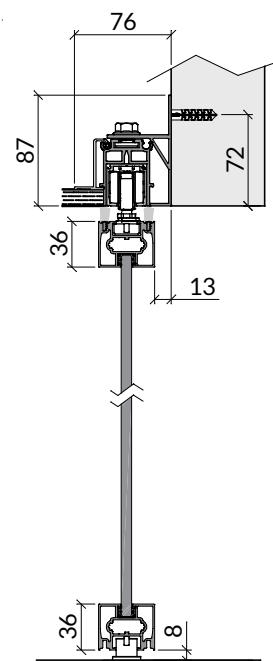

Profili anta

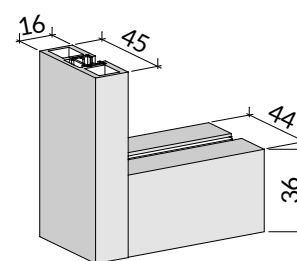

Per ulteriori informazioni tecniche consulta la scheda tecnica sul listino - For further technical information consult the technical data sheet on the price list

MASCA
trasforma gli ambienti:
le porte scorrono come
per magia, rendendo
ogni movimento di
apertura e chiusura
un'esperienza unica

MASCA
*transform environments:
doors slide as if by
magic, making every
opening and closing
movement a unique
experience*



MASCA VISIONI PROFILE

SCORREVOLE ESTERNO MURO

Visioni Profile

Porta scorrevole esterno muro
Vetro trasparente extrachiaro con profili gold
Sistema di scorrimento **Masca**
Maniglione MAN-PR28

Visioni Profile

*External wall sliding door
Extra-clear transparent glass with gold profiles
Masca sliding system
MAN-PR28 pull handle*







SCORREVOLE ESTERNO MURO MASCA

Finiture disponibili



Caratteristiche tecniche

Portata massima 70 Kg/anta
 Altezza massima foro muro 2800 mm
 Larghezza minima anta 700 mm
 Ammortizzato

Technical features

Maximum load 70 Kg/leaf
 Maximum wall opening height 2800 mm
 Minimum door width 700 mm
 Amortized

Versioni disponibili

Versions available



Passaggio chiuso con apertura parziale

Passage closed

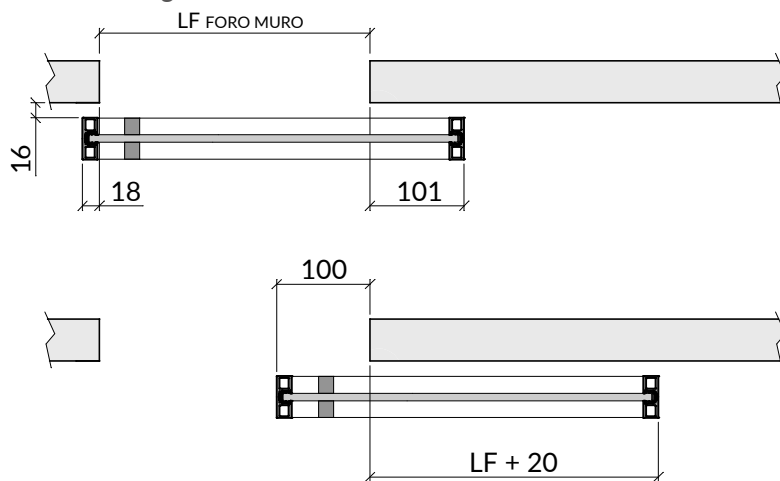

sormonto anta sul muro 18 mm
 sul lato maniglia
 sormonto anta sul muro 101 mm
 sul lato opposto maniglia
 distanza anta dal muro 16 mm

door overlap on the wall 18 mm
 on the handle side
 door overlap on the wall 101 mm
 on the side opposite the handle
 door distance from the wall 16 mm

Fissaggio binario a parete

Track fixing to the wall

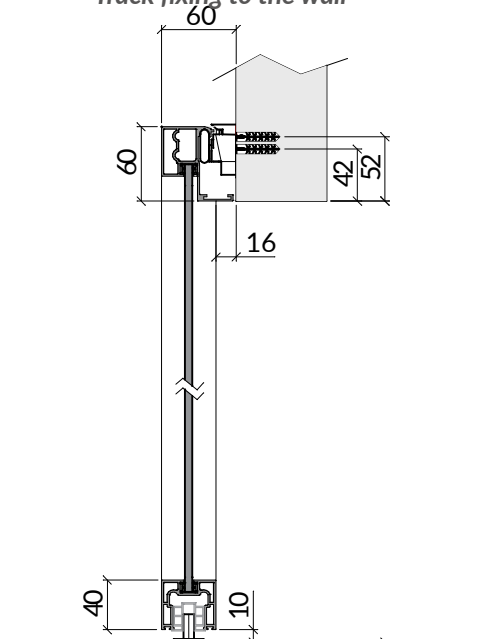

Passaggio chiuso con apertura totale

Passage closed

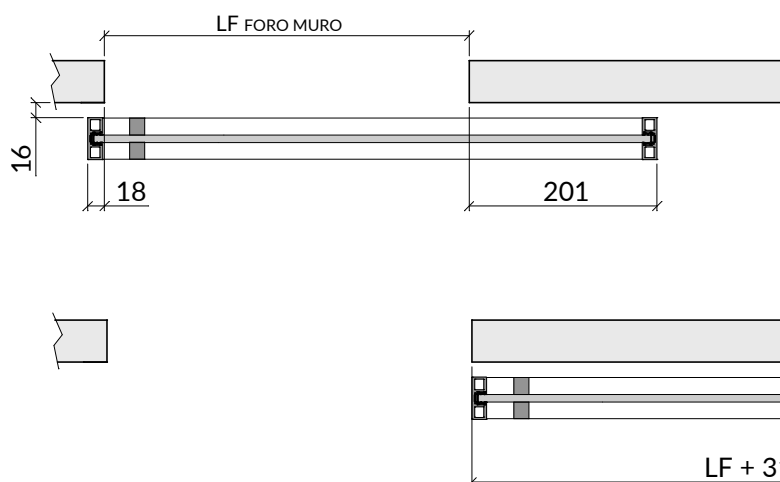

sormonto anta sul muro 18 mm
 sul lato maniglia
 sormonto anta sul muro 201 mm
 sul lato opposto maniglia
 distanza anta dal muro 16 mm

door overlap on the wall 18 mm
 on the handle side
 door overlap on the wall 201 mm
 on the side opposite the handle
 door distance from the wall 16 mm

Profili anta

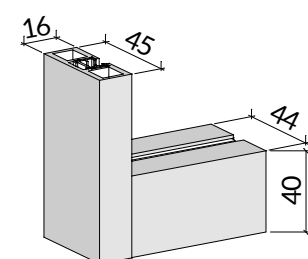

Per ulteriori informazioni tecniche consulta la scheda tecnica sul listino - For further technical information consult the technical data sheet on the price list





VENERE:
l'armonia del design
Una porta in vetro
con profili, scorrevole
interno muro, con
telaio, che coniuga
estetica e funzionalità
per un ambiente
raffinato

VENERE:
*the harmony of design A
glass door with profiles,
sliding inside the wall,
with frame, which
combines aesthetics and
functionality for a refined
environment*

VENERE VISIONI PROFILE

SCORREVOLE INTERNO MURO CON TELAIO

Visioni Profile

Porta scorrevole interno muro
Vetro trasparente grigio con profili alluminio
Maniglione MAN-PR28 alluminio
Telaio TX finitura grigio matt

Visioni Profile

*Internal wall sliding door
Gray glass with aluminum profiles
MAN-PR28 pull handle aluminium
Matt gray finish TX frame*



DYANA:
l'essenza dell'eleganza
minimalista Una porta
in vetro con profili,
scorrevole interno
muro, senza telaio,
che conferisce stile e
modernità all'ambiente

*DYANA:
the essence of minimalist
elegance A glass door
with profiles, sliding
inside the wall, without
frame, which gives style
and modernity to the
environment*

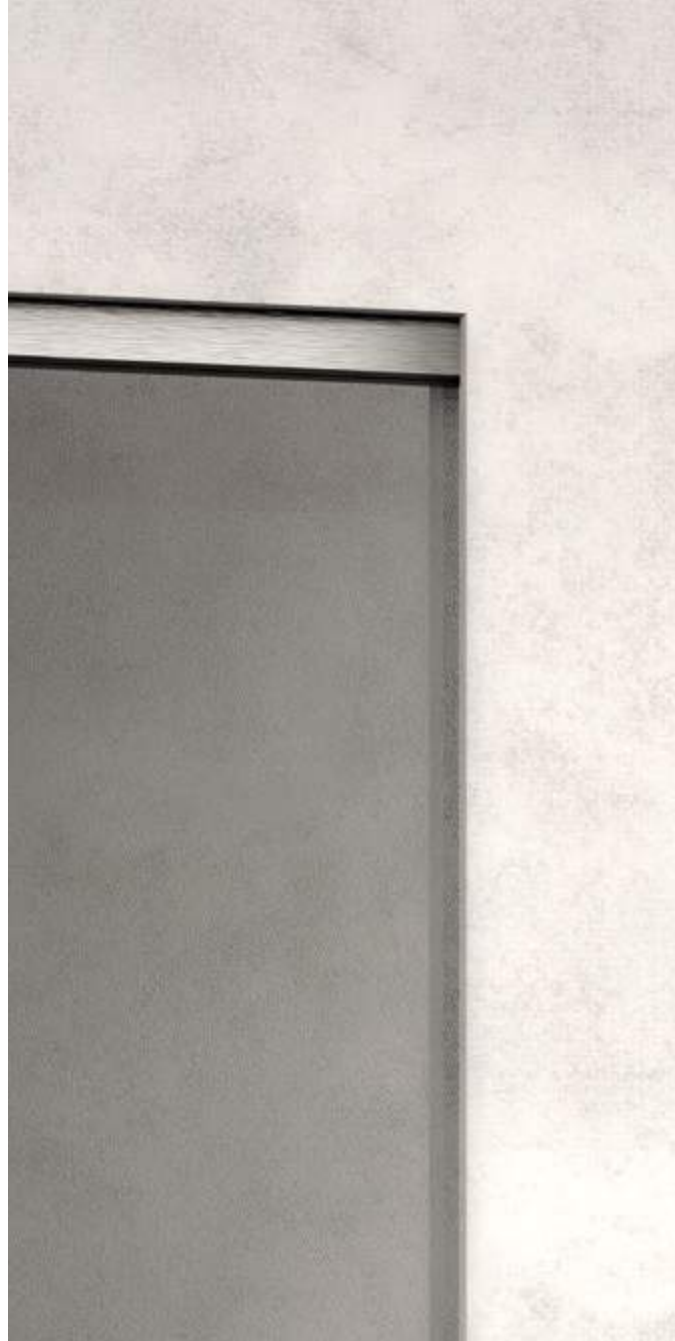

DYANA

VISIONI PROFILE

SCORREVOLE INTERNO MURO SENZA TELAIO



Visioni Profile

Porta scorrevole interno muro senza telaio
Vetro trasparente extrachiaro con profili alluminio
Maniglione MAN-PR28 alluminio

Visioni Profile

*Internal wall sliding door without frame
Extra clear glass with aluminum profiles
MAN-PR28 aluminum pull handle*





SCORREVOLE INTERNO MURO CON TELAIO **VENERE**

Finiture disponibili



Caratteristiche tecniche

Portata massima 100 Kg/anta
 Altezza massima anta 3000 mm
 Larghezza massima binario 400 mm

Technical features

Maximum load 100 Kg/leaf
 Maximum height door 3000 mm
 Minimum door width 400 mm

Versioni disponibili Versions available

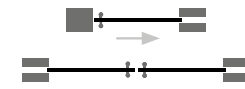

Per ulteriori informazioni tecniche consulta la scheda tecnica sul listino - For further technical information consult the technical data sheet on the price list

Porta scorrevole interno muro Venere Venere internal sliding door

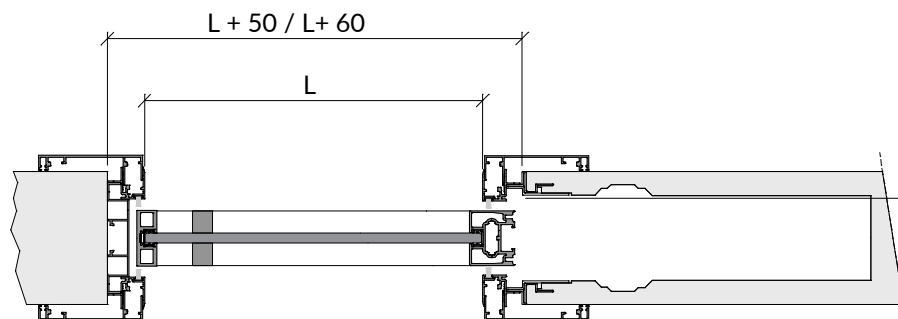

Porta scorrevole interno muro Venere Venere internal sliding door

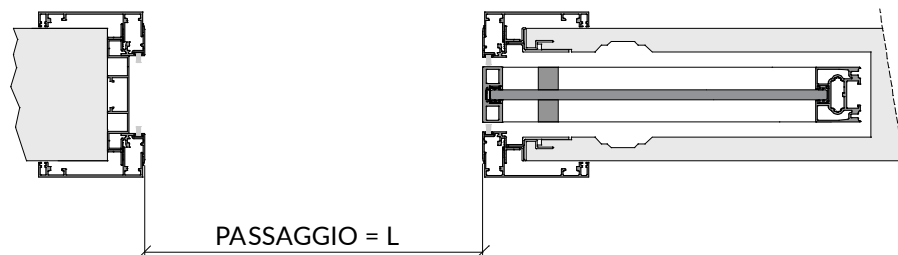

Sezione verticale Vertical section

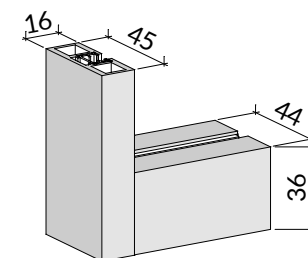
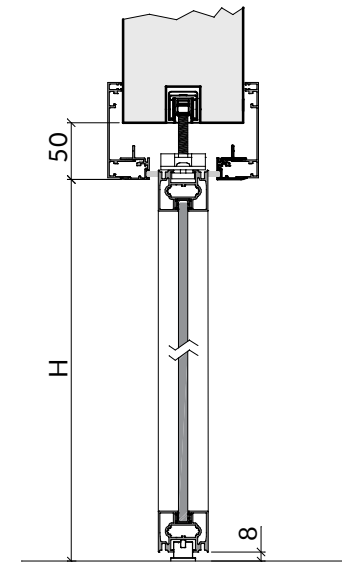

SCORREVOLE INTERNO MURO SENZA TELAIO **DYANA**

Finiture disponibili



Caratteristiche tecniche

Portata massima 100 Kg/anta
 Altezza massima anta 3000 mm
 Larghezza minima anta 400 mm

Technical features

Maximum load 100 Kg/leaf
 Maximum height door 3000 mm
 Minimum door width 400 mm

Versioni disponibili Versions available

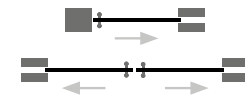

Porta scorrevole interno muro Dyana Dyana internal sliding door

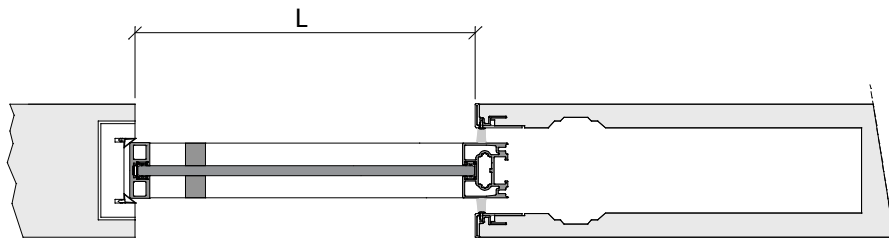

Porta scorrevole interno muro Dyana Dyana internal sliding door

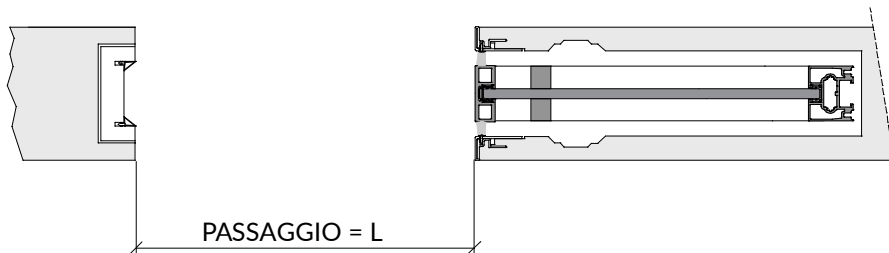

Sezione verticale Vertical section

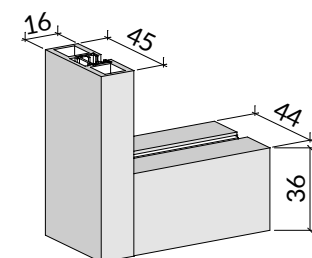
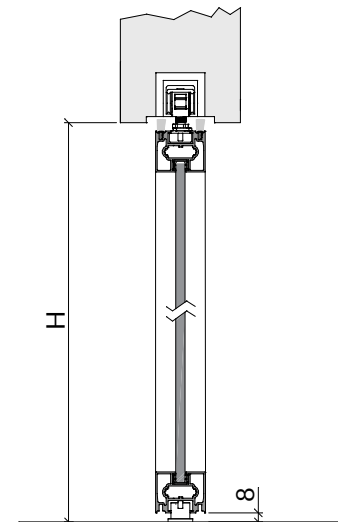

Per ulteriori informazioni tecniche consulta la scheda tecnica sul listino - For further technical information consult the technical data sheet on the price list

IRIS:
il fulcro del design
Una porta pivot in
vetro con profili che
funge da fulcro nel tuo
spazio, trasformando
ogni apertura in un
atto di eleganza e
innovazione

IRIS:
the fulcrum of design
A pivot glass door
with profiles that acts
as a fulcrum in your
space, transforming
every opening into an
act of elegance and
innovation



IRIS

VISIONI PROFILE

P O R T A A B I L I C O P I V O T

Visioni Profile

Porta a bilico pivot
Vetro trasparente bronzo con profili sohara
Sistema di apertura bilico decentrata

Visioni Profile

Pivot door
Transparent bronze glass with sohara profiles
Decentralized pivot opening system







PORTA A BILICO PIVOT IRIS



Iris con cerniera a filo anta

Finiture disponibili



Caratteristiche tecniche

Portata massima 100 Kg/anta
 Chiusura oleodinamica
 Larghezza massima passaggio 1000 mm
 Larghezza massima anta 1000 mm

Technical features

Maximum load 100 Kg/leaf
 Hydraulic closing
 Maximum passage width 1000 mm
 Maximum door width 1000 mm



Iris con cerniera decentrata

Finiture disponibili



Caratteristiche tecniche

Portata massima 100 Kg/anta
 Chiusura oleodinamica
 Larghezza massima passaggio 1000 mm
 Larghezza massima anta 1600 mm

Technical features

Maximum load 100 Kg/leaf
 Hydraulic closing
 Maximum passage width 1000 mm
 Maximum door width 1600 mm

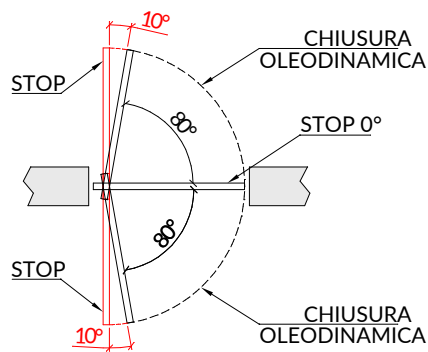

Versioni disponibili

Versions available

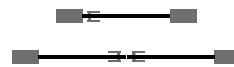

Sezione verticale muro a vista

Vertical section exposed wall

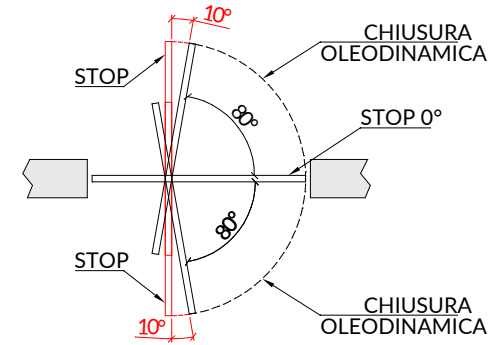
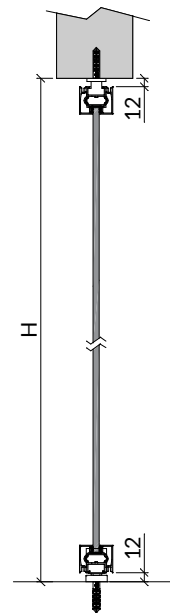

Iris con cerniera a filo anta, muro a vista

Iris with flush hinge, exposed wall

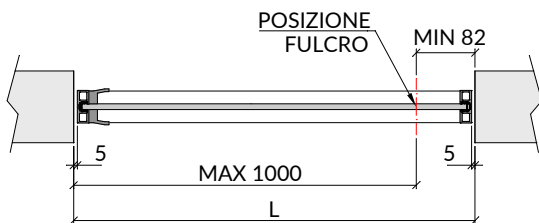

Iris con cerniera decentrata, muro a vista

Iris with decentralized hinge, exposed wall

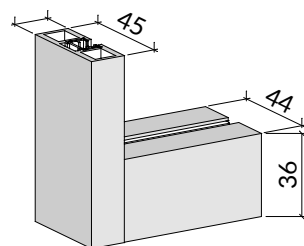
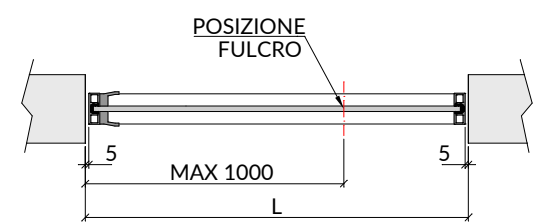

Per ulteriori informazioni tecniche consulta la scheda tecnica sul listino - For further technical information consult the technical data sheet on the price list





HARPA:
l'incarnazione della
bellezza funzionale,
una Porta a battente
in vetro con profili e
telaio, che combina
estetica e solidità per
un ambiente di classe

*HARPA:
the embodiment of
functional beauty,
a glass swing
door with profiles
and frame, which
combines aesthetics
and solidity for a
classy environment*

HARPA

VISIONI PROFILE

P O R T A A B A T T E N T E

Visioni Profile

Porta a battente con serratura orizzontale
Vetro trasparente extrachiario con profilo verniciato bianco
Telaio TN bianco Ral 9016

Visioni Profile

*Swing door with horizontal lock
Extra-clear transparent glass with white painted profile
White Ral 9016 TN frame*





PORTA A BATTENTE HARPA

Finiture disponibili



Caratteristiche tecniche
 Portata massima 60 Kg/anta
 Altezza massima anta 2700 mm
 Larghezza massima anta 900 mm

Technical features
 Maximum load 60 Kg/leaf
 Maximum height door 2700 mm
 Maximum door width 900 mm

Versioni disponibili

Versions available

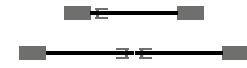

Telai disponibili vedi pag 104
 Available frames see page 104

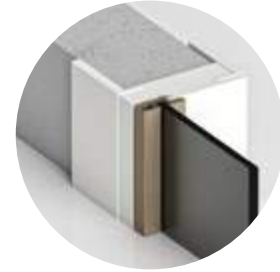

Per ulteriori informazioni tecniche consulta la scheda tecnica sul listino - For further technical information consult the technical data sheet on the price list

Porta a battente Harpa con telaio in legno

Harpa swing door with wooden frame

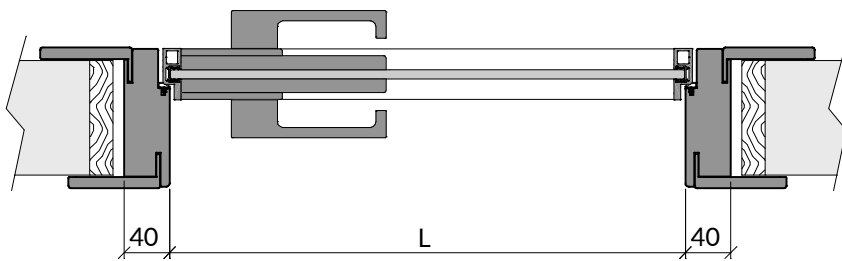

Porta a battente Harpa con telaio raso muro

Harpa swing door with flush-fitting frame

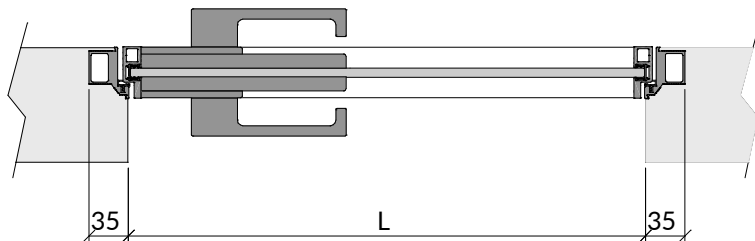

Harpa con telaio in legno

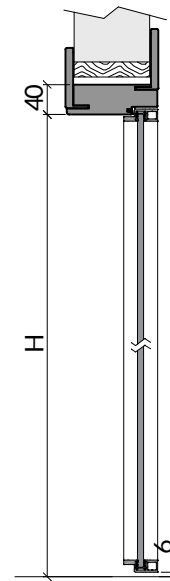

Harpa con telaio raso muro

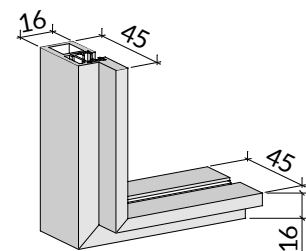
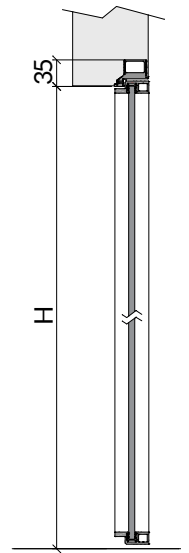

ANTILIA:
l'arte dell'essenzialità,
una porta in vetro
battente che unisce
semplicità e raffinatezza
per un ambiente
moderno
ed accogliente

ANTILIA:
*the art of essentiality,
a swing glass door
which combines
simplicity and
refinement for a
modern environment*



ANTILIA

VISIONI PROFILE

PORTA A BATTENTE

Visioni Profile

Porta a battente con serratura verticale
profilo Standard bronzo
vetro Extrachiaro trasparente

Visioni Profile

*Swing door with vertical lock
Standard Bronze profiles,
Extra-clear transparent glass*



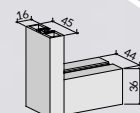

Profilo *Standard*

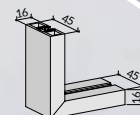

Profilo *Lite*



PORTA A BATTENTE **ANTILIA** con profilo *Standard*

Finiture disponibili



Caratteristiche tecniche

Portata massima 60 Kg/anta
 Altezza massima anta 2700 mm
 Larghezza massima anta 900 mm

Technical features

Maximum load 60 Kg/leaf
 Maximum height door 2700 mm
 Maximum door width 900 mm

Versioni disponibili

Versions available

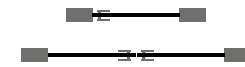

Telai disponibili vedi pag 104
 Available frames see page 104



Per ulteriori informazioni tecniche consulta la scheda tecnica sul listino - For further technical information consult the technical data sheet on the price list

Porta a battente Antilia con telaio in legno

Antilia swing door with wooden frame

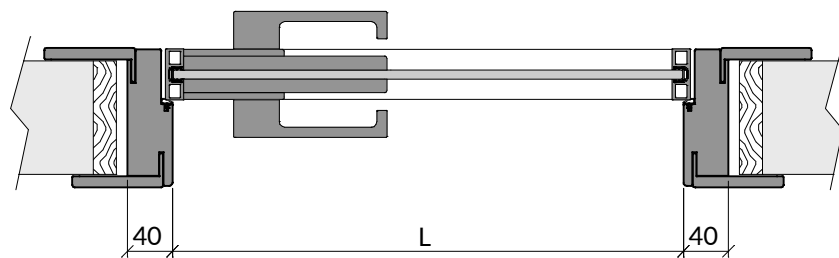

Porta a battente Antilia con telaio in alluminio

Antilia swing door with aluminum frame

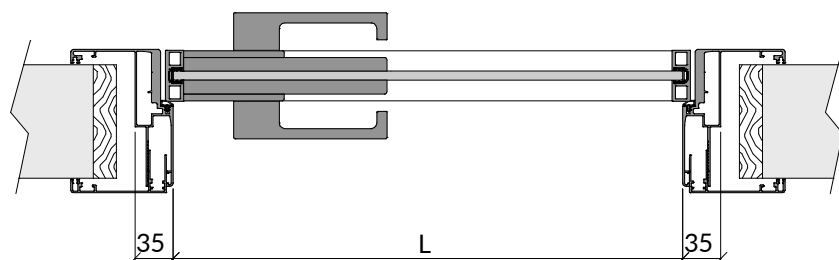

Antilia con telaio in legno

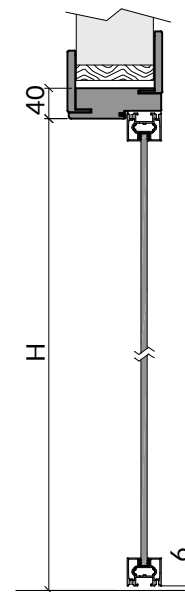

Antilia con telaio in alluminio

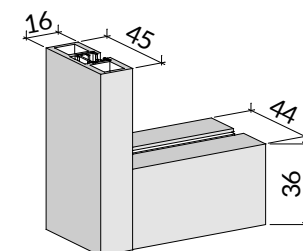
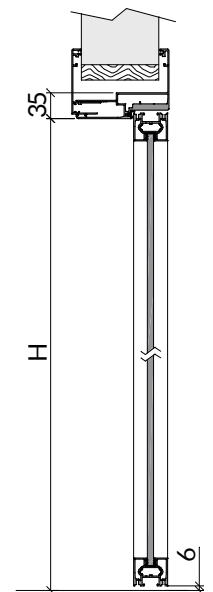

PORTA A BATTENTE **ANTILIA** con profilo *Lite*

Finiture disponibili



Caratteristiche tecniche

Portata massima 60 Kg/anta
Altezza massima anta 2700 mm
Larghezza massima anta 900 mm

Technical features

Maximum load 60 Kg/leaf
Maximum height door 2700 mm
Maximum door width 900 mm

Versioni disponibili Versions available

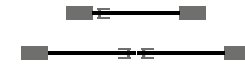

Telai disponibili vedi pag 104 Available frames see page 104

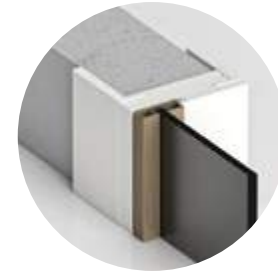

Per ulteriori informazioni tecniche consulta la scheda tecnica sul listino - For further technical information consult the technical data sheet on the price list

Porta a battente Antilia con telaio in legno Antilia swing door with wooden frame

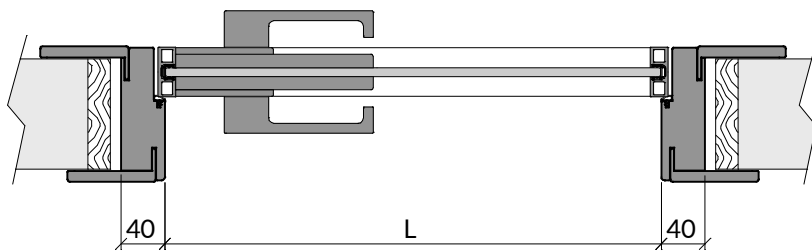

Porta a battente Antilia con telaio in alluminio Antilia swing door with aluminum frame

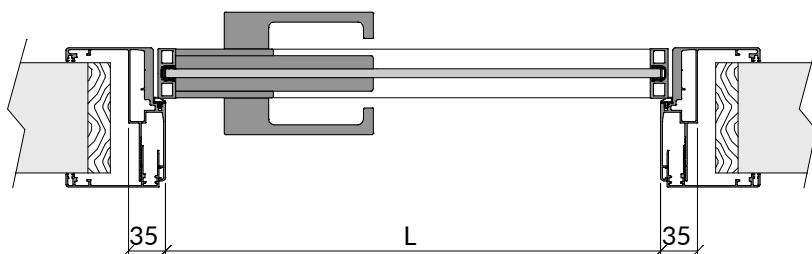

Antilia con telaio in legno

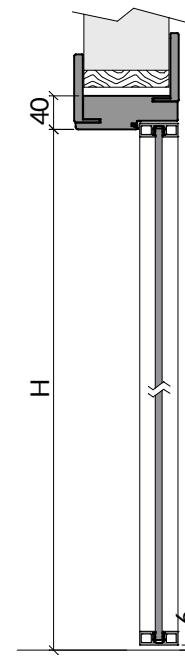

Antilia con telaio in alluminio

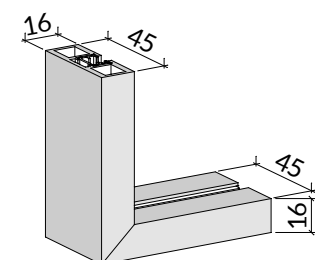
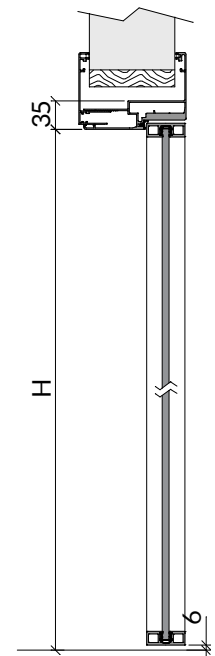

TELAI **BATTENTI** per porte *Visioni Profile*

 **Telaio TN**
in legno/wood

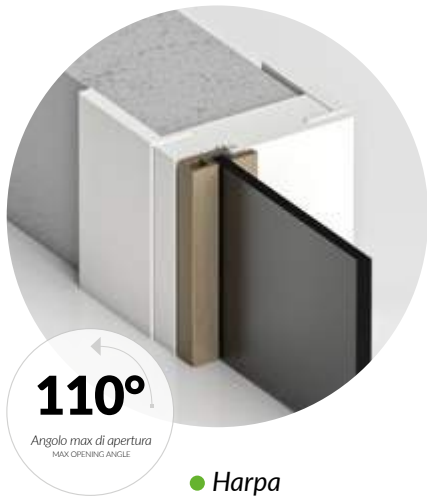

 **Telaio TS**
in legno/wood

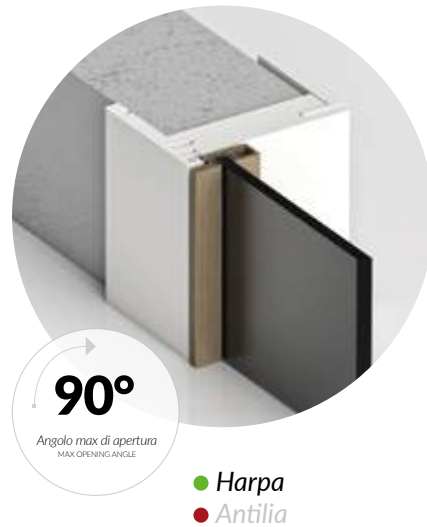

 **Telaio TSP**
in legno/wood



 **Telaio TX**
in legno/wood



 **Telaio TXS**
in legno/wood

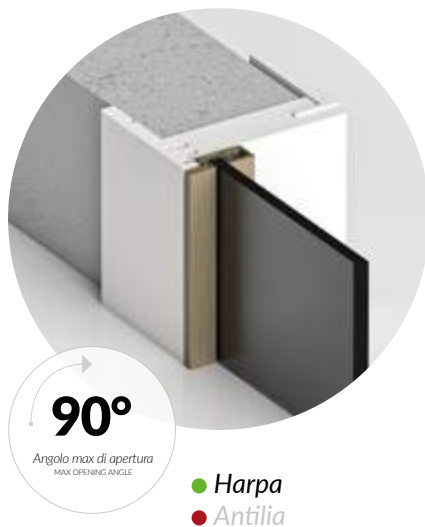

 **Telaio TA**
in alluminio/aluminium



 **Telaio RSN**
rasomuro/close to the wall

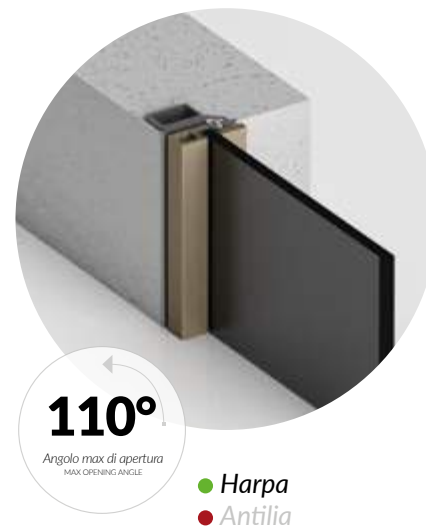

Tipologie di **APERTURA** per porte *Visioni Profile*



Scorrevole esterno muro *Velo*



Scorrevole esterno muro *Nexus*



Scorrevole esterno muro *Masca*



Scorrevole interno muro *Venere*



Scorrevole interno muro *Dyana*



Porta bilico pivot *Iris*



Porta a battente *Harpa*



Porta a battente *Antilia*



IL VETRO OLTRE I SUOI CONFINI

Viaggia oltre i confini dell'estetica tradizionale con i modelli Profile Industrial di Visioni, dalle texture del Rovere Touch alle trame metalliche, ai vetri materici, esplora il futuro del design

Travel beyond the boundaries of traditional aesthetics with Visioni's Profile Industrial models From the textures of Touch Oak to metal textures and material glass, explore the future of design

Visioni Profile
Porta doppia scorrevole opposta
esterno muro **Wood3**
con profili black
Vetro trasparente extrachiario
Sistema di scorrimento **Velo**

Visioni Profile
*Double sliding door outside the
wall Wood 3 with black profiles
Extra-clear transparent glass
Velo sliding system*





VETRO E LEGNO

GLASS AND WOOD

Il vetro incornicia
il legno, creando
un quadro di
armoniosi contrasti

THE GLASS FRAMES WOOD,
CREATING A PAINTING OF
HARMONIOUS CONTRASTS



Visioni Profile
 Porta a battente **Antilia**,
 Vetro trasparente extrachiaro
 Modello **Wood1**
 con profili standard black

Visioni Profile
 Antilia swing door,
 Extra-clear transparent glass
 Wood1 model
 with standard Black profiles



Visioni Profile
Wood1



Visioni Profile
Wood2



Visioni Profile
Wood3



Visioni Profile
Wood4



Visioni Profile
Wood5



Visioni Profile
Wood6



Visioni Profile
Wood7

Visioni Profile
Porta a battente **Harpa**,
vetro satinato extrachiaro
Modello **Wood6**

Visioni Profile
*Harpa swing door,
Extra-clear satin glass
Wood6 model*





Visioni Profile
 Porta battente rasomuro **Harpa**
 vetro **Chocolate Canvas**
 con profili verniciati moon
 Serratura orizzontale

Visioni Profile
Harpa flush-fitting hinged door
Chocolate Canvas glass
with moon painted profiles
Horizontal lock



Visioni Profile
 Porta doppia scorrevole interno
 passata su ante fisse
 vetro **Cream Canvas**
 con profili verniciati sohara
 Maniglia MAN-PR28

Visioni Profile
Internal sliding double door
passed on fixed doors
Glass Cream Canvas
with sohara painted profiles
MAN-PR28 handle

VETRO E TESSUTO

GLASS AND CANVAS

Trasparenze
intrecciate in un
legame sottile

TRANSPARENCIES
INTERTWINED IN ONE
SUBTLE BOND



Visioni Profile
Porta scorrevole esterno muro
Sistema di scorrimento **Velo**
con profili verniciati akenar
Vetro **Desert Canvas**
Maniglia MAN-PR28

Visioni Profile
*External wall sliding door
Velo sliding system
with akenar painted profiles
Desert Canvas glass
MAN-PR28 handle*

Visioni Profile
Porta a battente **Harpa**
Vetro **Lijnen Canvas**
con profili verniciati bianchi
Serratura orizzontale

Visioni Profile
*Hinged door Harpa
Lijnen Canvas glass
with white painted profiles
Horizontal lock*





VETRO A SCACCHI

GLASS CHESS

Lo stile
"Industrial"
di Visioni Profile

THE "INDUSTRIAL" STYLE
OF VISIONI PROFILE



Visioni Profile

Porta scorrevole interno passata su anta fissa
Vetro satinato extrachiaro, modello **Unsquare 5**
con profili verniciati blue marine

Visioni Profile

*Internal sliding door passed on fixed door
Extra-clear satin glass, Unsquare 5 model
with blue marine painted profiles*





Visioni Profile
 Porta scorrevole esterno muro
 Vetro trasparente extrachiario
 Modello **Unsquare1** con profili black
 Sistema di scorrimento **Velo**
 Maniglia MAN-PR28

Visioni Profile
 External wall sliding door
 Extra-clear transparent glass
 Unsquare1 model with black profiles
 Velo sliding system
 MAN-PR28 handle



Visioni Profile
Unsquare 1



Visioni Profile
Unsquare 2

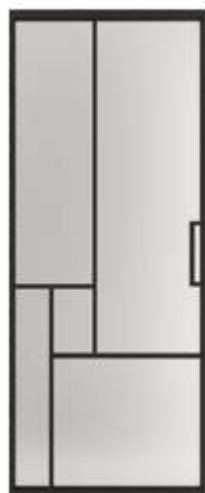

Visioni Profile
Unsquare 3



Visioni Profile
Unsquare 4



Visioni Profile
Unsquare 5

Visioni Profile
Porta scorrevole esterno muro
Vetro trasparente extrachiario
Modello **Unsquare3** con profili alluminio
Sistema di scorrimento **Velo**
Maniglia MAN-PR28

*Visioni Profile
External wall sliding door
Extra-clear transparent glass
Unsquare3 model with aluminum profiles
Velo sliding system
MAN-PR28 handle*



Visioni Profile
Porta scorrevole esterno muro
vetro trasparente extrachiaro
Modello **Square6** con profili bronzo
Sistema di scorrimento **Nexus**
Maniglia MAN-PR28

Visioni Profile
External wall sliding door
Extra-clear transparent glass
Square6 model with bronze profiles
Nexus sliding system
MAN-PR28 handle





Visioni Profile
 Porta doppia scorrevole opposta esterno muro
 Vetro trasparente extrachiario
 modello **Square5** con profili standard black
 Sistema di scorrimento **Velo**
 Maniglia MAN-PR28

Visions Profile
 Double sliding door opposite external wall
 Extra-clear transparent glass
 Square5 model with standard black profiles
 Velo sliding system
 MAN-PR28 handle



Visioni Profile
 Square 1



Visioni Profile
 Square 2

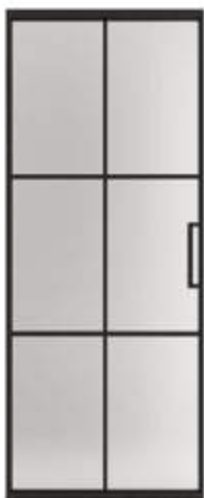

Visioni Profile
 Square 3

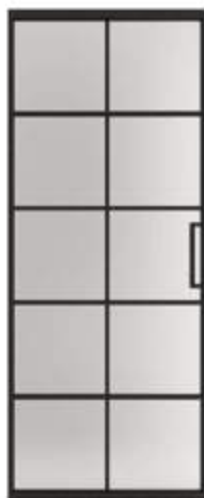

Visioni Profile
 Square 4

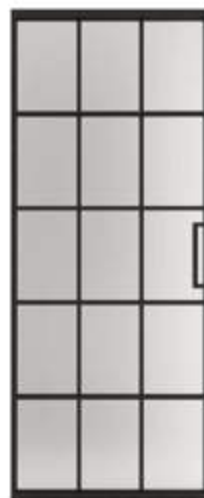

Visioni Profile
 Square 5

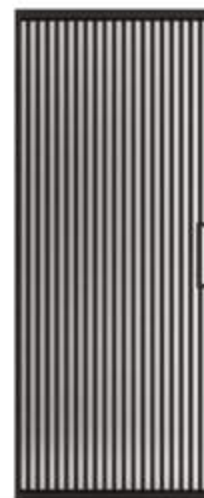

Visioni Profile
 Square 6

Visioni Profile

Porta quadrupla scorrevole esterno muro
trascinata opposta con profili alluminio
Vetro **Lite connection** trasparente bronzo
Sistema di scorrimento **Nexus**
Maniglia MAN-PR28

Visioni Profile

*Quadruple sliding door outside the wall,
opposite dragging with aluminum profiles
Lite connection glass Transparent bronze
Nexus sliding system
MAN-PR28 handle*





LA RETE NEL VETRO

THE NET IN THE GLASS

Il vetro con un cuore
d'acciaio, elegante e
raffinato, per ambienti
di gran classe

GLASS WITH A HEART OF STEEL,
ELEGANT AND REFINED, FOR
HIGH-CLASS ENVIRONMENTS





Visioni Profile

Porta doppia battente **Antilia**
Vetro **Wide Connection** trasparente extrachiario
con profili anodizzati e telaio TA
Maniglia Minimal SM

Visioni Profile

Double swing door **Antilia**
Wide Connection glass extra-clear transparent
with knotted profiles and frame TA
Minimal SM handle



Visioni Profile

Porta doppia scorrevole
interno passata su anta fissa
Vetro **Medium Connection** Trasparente grigio
con profili verniciati light grey
Sistema di scorrimento **Velo** a soffitto
Maniglia MAN-PR28

Visioni Profile

Internal double sliding door
passed on fixed leaf
Medium Connection Transparent gray glass
with light grey painted profiles
Velo ceiling sliding system
MAN-PR28 handle



Visioni Profile

Porta a battente Antilia
Vetro **Kamyl** trasparente bronzo
con profili dark bronze
Serratura verticale

Visioni Profile

Antilia swing door
Bronze transparent Kamyl glass
with dark bronze profiles
Vertical lock



Vetro **Stowe** extrachiario
Extra-clear Stowe glass

VETRO IN RILIEVO

GLASS IN RELIEF

L'espressione
materica del
vetro prende
forma

THE MATERIAL EXPRESSION
OF GLASS TAKES SHAPE

Visioni Profile

Porta scorrevole esterno muro
Vetro **Stowe** extrachiaro
con profili verniciati antique brass
Sistema di scorrimento **Nexus**
Maniglia MAN-PR28

Visioni Profile

External wall sliding door
Extra-clear Stowe glass
with antique brass painted profiles
Nexus scroll system
MAN-PR28 handle







Visioni Profile

Porta scorrevole esterno muro **Velo**
Vetro **Kostel** trasparente extrachiario
con profili verniciati bianchi
Maniglia MAN-PR28

Visioni Profile

*Velo external wall sliding door
Extra-clear transparent Kostel glass
with white painted profiles
MAN-PR28 handle*



Visioni Profile

Porta doppia scorrevole interno passata su ante fisse
Vetro **Hays** trasparente extrachiario
con profili verniciati blue marine
Sistema di scorrimento **Velo** a soffitto
Maniglia MAN-PR28

Visioni Profile

*Internal sliding double door on fixed leaves
Hays glass extra-clear transparent
with blue marine painted profiles
Velo ceiling sliding system
MAN-PR28 handle*



IL VETRO ED I COLORI

Dipingi con la luce e i colori.
Entra nel mondo magico
delle decorazioni vetro, dove
la luce e il colore si fondono
per creare opere uniche

*Paint with light and colors.
Enter the magical world of glass decorations, where
light and color blend to create unique works*



LINEARITÀ DINAMICHE

DYNAMIC LINEARITIES

L'eleganza dei modelli esclusivi
Visioni su porte in vetro,
dove semplici tratti creano
un'estetica pulita e moderna,
trasformando gli spazi con uno
stile senza tempo

*The elegance of our linear models
on glass doors, where simple
lines create a clean and modern
aesthetic, transforming spaces
with a timeless style*

Visioni

Porta doppia scorrevole opposta
Decoro lucido **Linha** (LN07). Lavorazione AT
Vetro satinato extrachiario
Sistema di scorrimento **Essenza**
Maniglione MAN-T66 Inox Satinato

Visioni

*Opposite double sliding door
Shiny Linha decoration (LN07). AT workmanship
Extra-clear satin glass
Essenza sliding system
MAN-T66 Satin Stainless Steel Handle*

Visioni
Porta a battente **Style**
Decoro **Blades** (LN11) trasparente fondo sabbiato - Lavorazione ST
(disponibile anche nella versione Satcolor Ceramico)
Serratura Style MN

Visioni
Style swing door
Blades decoration (LN11) transparent sandblasted background - ST processing
(also available in the Satcolor Ceramico version)
Style MN lock





Visioni

Porta scorrevole esterno muro
 Decoro **Layer** (LN09) antracite. Lavorazione AD
 Sistema di scorrimento **Cubo Fluid**
 Maniglione MAN-Q46 inox satinato

Visioni

External wall sliding door
 Anthracite Layer decoration (LN09). AD workmanship
 Cubo Fluid sliding system
 MAN-Q46 satin stainless steel handle

Visioni

Porta a battente **Athena**
 Decoro sabbato **Three** (LN05)
 vetro satinato grigio
 Lavorazione AS
 Serratura Athena ATM

Visioni

Athena swing door
 Sandblasted decoration Three (LN05)
 gray satin glass
 AS workmanship
 Athena ATM lock



Visioni
Porta scorrevole esterno muro
Decoro **Laser** (LN15) satcolor cielo e trasparente
fondo satcolor satinato - Lavorazione AD
Sistema di scorrimento **Luna Soft Close**
Maniglione MAN-T66

Visioni
External wall sliding door
Laser decoration (LN15)
satin sky color and transparent
satin satin background - AD workmanship
Luna Soft Close sliding system
MAN-T66 handle



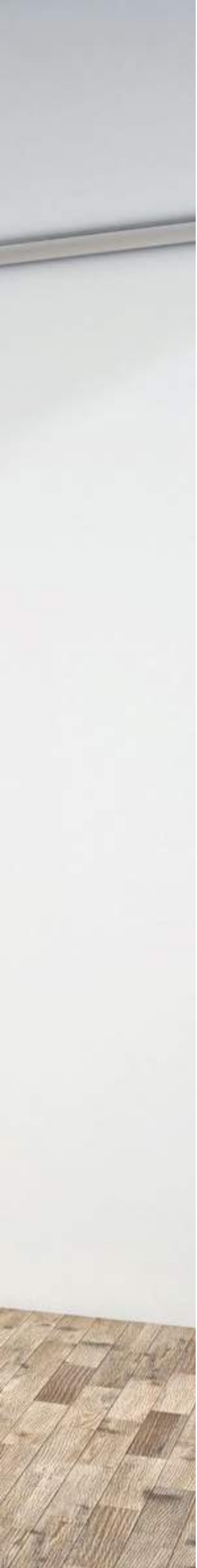

Visioni
Porta a battente **Style** rasomuro
Decoro **Three** (LN05) abbiato
Vetro trasparente bronzo
Lavorazione TS
Maniglione MAN-Q116

Visioni
Style flush-to-the-wall swing door
Sandblasted Three (LN05) decoration
Transparent bronze glass
TS workmanship
MAN-Q116 handle



Visioni

Porta scorrevole esterno muro
Decoro **Laser** (LN15) sabbiato. Lavorazione AS
Vetro satinato grigio
Sistema di scorrimento **Puro Soft Close**
Maniglione MAN-T46 inox satinato

Visioni

*External wall sliding door
Sandblasted laser decoration (LN15). AS workmanship
Gray satin glass
Puro Soft Close sliding system
MAN-T46 satin stainless steel handle*

**Visioni**

Porta scorrevole esterno muro
Decoro **Na Kea** (LN16) sabbiato vetro trasparente grigio
Lavorazione TS - Sistema di scorrimento **Puro Soft Close**
Maniglione MAN-T46 inox satinato

Visioni

*External wall sliding door
Na Kea decoration (LN16) sandblasted gray transparent glass
TS workmanship - Puro Soft Close sliding system
MAN-T46 satin stainless steel handle*





Visioni

Porta scorrevole interno passata
su anta fissa
Decoro **Rain** (LN21) sabbiato
Vetro trasparente extrachiaro
Lavorazione TS
Sistema di scorrimento **Essenza**
Maniglia VAS-T

Visioni

*Internal sliding door passed
on fixed door
Sandblasted Rain decoration (LN21)
Extra-clear transparent glass
TS workmanship
Essenza sliding system
VAS-T handle*



Visioni

Porta scorrevole esterno muro
Decoro **Linah** (LN22) satcolor tortora ed
effetto satinato vetro trasparente extrachiaro
Lavorazione TD
Sistema di scorrimento **Puro Soft Close**
Maniglione MAN-T30 Inox Satinato

Visioni

External wall sliding door
Linah (LN22) satin dove gray decoration and
satin effect extra-clear transparent glass
TD workmanship
Puro Soft Close sliding system
MAN-T30 satin stainless steel handle





INTRECCI NATURALI

N A T U R A L W E A V I N G S

Un'ode alla bellezza, con modelli che riproducono con maestria alberi, rami e fiori. Porta l'esterno dentro casa e abbraccia la bellezza della natura.

An ode to beauty, with models that expertly reproduce trees, branches and flowers. Bring the outdoors indoors and embrace the beauty of nature.

Visioni

Porta quadrupla scorrevole
trascinata opposta esterno muro
Decoro **Albero** (LN26) sabbiato
Vetro trasparente extrachiario - Lavorazione TS
Sistema di scorrimento **Essenza**
Maniglione MAN-T66

Visioni

Quadruple sliding door
dragged opposite external wall
Sandblasted Albero decoration (LN26)
Extra-clear transparent glass - TS workmanship
Essenza sliding system
MAN-T66 handle

Visioni

Porta doppia scorrevole esterno muro
Decoro **Albero** (LN26) sabbiato
Vetro satinato bronzo - Lavorazione AS
Sistema di scorrimento **Cubo Fluid**
Maniglia VAS-Q

Visioni

Double sliding door External Wall
Sandblasted tree decoration (LN26)
Bronze satin glass - AS workmanship
Cubo Fluid sliding system
VAS-Q handle

Visioni

Porta scorrevole esterno muro
Decoro **Albero** (LN26) sabbiato
Vetro trasparente grigio - Lavorazione TS
Sistema di scorrimento **Luna Soft Close**
Maniglione MAN T116

Visioni

Sliding door external wall
Sandblasted Albero decoration (LN26)
Transparent gray glass - TS workmanship
Luna Soft Close sliding system
MAN T116 handle





Visioni
Porta doppia scorrevole Interno passata
Decoro **Rami** (LN25) sabbiato
Vetro satinato grigio - Lavorazione AS
Sistema di scorrimento **Essenza**
Maniglia VAS-Q

Visioni
Internal sliding double door
Sandblasted Rami decoration (LN25)
Gray satin glass - AS workmanship
Essenza sliding system
VAS-Q handle







Visioni
Porta doppia scorrevole trascinata su anta fissa interno passata
Decoro **Rami** (LN25) sabbiato vetro trasparente bronzo - Lavorazione TS
Sistema di scorrimento a **Veletta** - Maniglione MAN-QC

Visioni
*Double Sliding Door with sliding door on fixed leaf inside passed
Sandblasted Rami decoration (LN25) Transparent bronze glass - TS workmanship
Veil sliding system - MAN-QC pull handle*

Visioni
Porta scorrevole esterno muro
Decoro **Rami** (LN25) sabbiato
Vetro trasparente extrachiario
Lavorazione TS
Sistema di scorrimento **Essenza**
Maniglia VAS-T

Visioni
External wall sliding door
Sandblasted Rami decoration (LN25)
Extra-clear transparent glass
TS workmanship
Essenza sliding system
VAS-T handle

SEMPLICITÀ FLOREALI

SIMPLICITY FLORALS

Vetri lavorati con sabbiature
trasformano gli spazi in
opere d'arte floreali, unendo
funzionalità e bellezza

*Sandblasted glass transforms
spaces into floral works of art,
combining functionality and beauty*

Visioni
Porta scorrevole esterno muro
Decoro **Fiore** (LN27) sabbiato
Vetro satinato extrachiario - Lavorazione AS
Sistema di scorrimento **Luna Soft Close**
Maniglia MAN-T30

Visioni
External wall sliding door
Sandblasted Fiore decoration (LN27)
Extra-clear satin glass - AS workmanship
Luna Soft Close sliding system
MAN-T30 handle









ELEMENTI ESSENZIALI

ESSENTIAL ELEMENTS

Modelli che catturano gli
elementi fondamentali e
immagini straordinarie, design
che trasformano gli spazi in
finestre verso mondi inesplorati
e atmosfere suggestive

*Models that capture fundamental
elements and extraordinary images,
designs that transform spaces into
windows towards unexplored worlds
and evocative atmospheres*

Visioni

Porta doppia scorrevole esterno muro
Decoro **Acqua**
Satcolor su fondo satinato - Lavorazione AD
Sistema di scorrimento **Essenza**
Maniglione MAN-Q66

Visioni

*Double sliding door outside the wall
Acqua decoration
Satcolor on satin background - AD workmanship
Essenza sliding system
MAN-Q66 handle*

SCORCI URBANI

GLIMPSES URBAN

La suggestione dell'urbano
portato direttamente in
casa crea un'esperienza
affascinante e
contemporanea

*The suggestion of the urban
brought directly into the home
creates a fascinating and
contemporary experience*

Visioni

Porta scorrevole esterno muro
Decoro **Cortona**
Satcolor su fondo satinato - Lavorazione AD
Sistema di scorrimento **Cubo Fluid**
Maniglione MAN-Q46

Visioni

External wall sliding door
Cortona decoration
Satcolor on satin background - AD workmanship
Cubo Fluid sliding system
MAN-Q46 handle





SPIRALI COSMICHE

C O S M I C S P I R A L S

Oasi di serenità e ispirazione
naturale definiscono gli
spazi, regalando alla tua casa
un'atmosfera avvolgente
ed accogliente

*Oases of serenity and natural
inspiration define the spaces, giving
your home an enveloping and
welcoming atmosphere*

Visioni
Porta scorrevole esterno muro
Decoro **Hoola** (LN18) sabbiato
Vetro satinato extrachiaro
Lavorazione AS
Sistema di scorrimento **Essenza**
Maniglione MAN-T66

Visioni
*External wall sliding door
Sandblasted Hoola decoration (LN18)
Extra-clear satin glass
AS workmanship
Sliding system Essenza
MAN-T66 handle*





Visioni
Porta doppia scorrevole opposta
Decoro **Circle** (LN17) sabbiato
Vetro trasparente grigio
Lavorazione TS
Sistema di scorrimento **Maestro**
Maniglione MAN-Q66

Visioni
*Opposite double sliding door
Sandblasted Circle decoration (LN17)
Transparent gray glass
TS workmanship
Maestro sliding system
MAN-Q66 handle*



Visioni
Porta scorrevole esterno muro
Decoro **Halaii** (LN20) sabbiato
Vetro satinato extrachiario
Lavorazione AS
Sistema di scorrimento **Essenza**
Maniglione MAN-T46 inox satinato

Visioni
External wall sliding door
Sandblasted Halaii decoration (LN20)
Extra-clear satin glass
AS workmanship
Essenza sliding system
MAN-T46 satin stainless steel handle



Visioni
Porta doppia scorrevole opposta
Decoro **Hoola** (LN18) sabbiato
Vetro trasparente extrachiaro
Lavorazione TS
Sistema di apertura **Luna Soft Close**
Maniglia VAS-T

Visioni
*Opposite double sliding door
Sandblasted Hoola decoration (LN18)
Extra-clear transparent glass
TS workmanship
Luna Soft Close opening system
VAS-T Handle*



Visioni
Porta scorrevole esterno muro
Decoro **Halaii** (LN20) sabbiato
Vetro trasparente grigio
Lavorazione TS
Sistema di scorrimento **Puro Soft Close**
Maniglione MAN-T66

Visioni
*External wall sliding door
Sandblasted Halaii decoration (LN20)
Transparent gray glass
TS workmanship
Puro Soft Close sliding system
MAN-T66 handle*



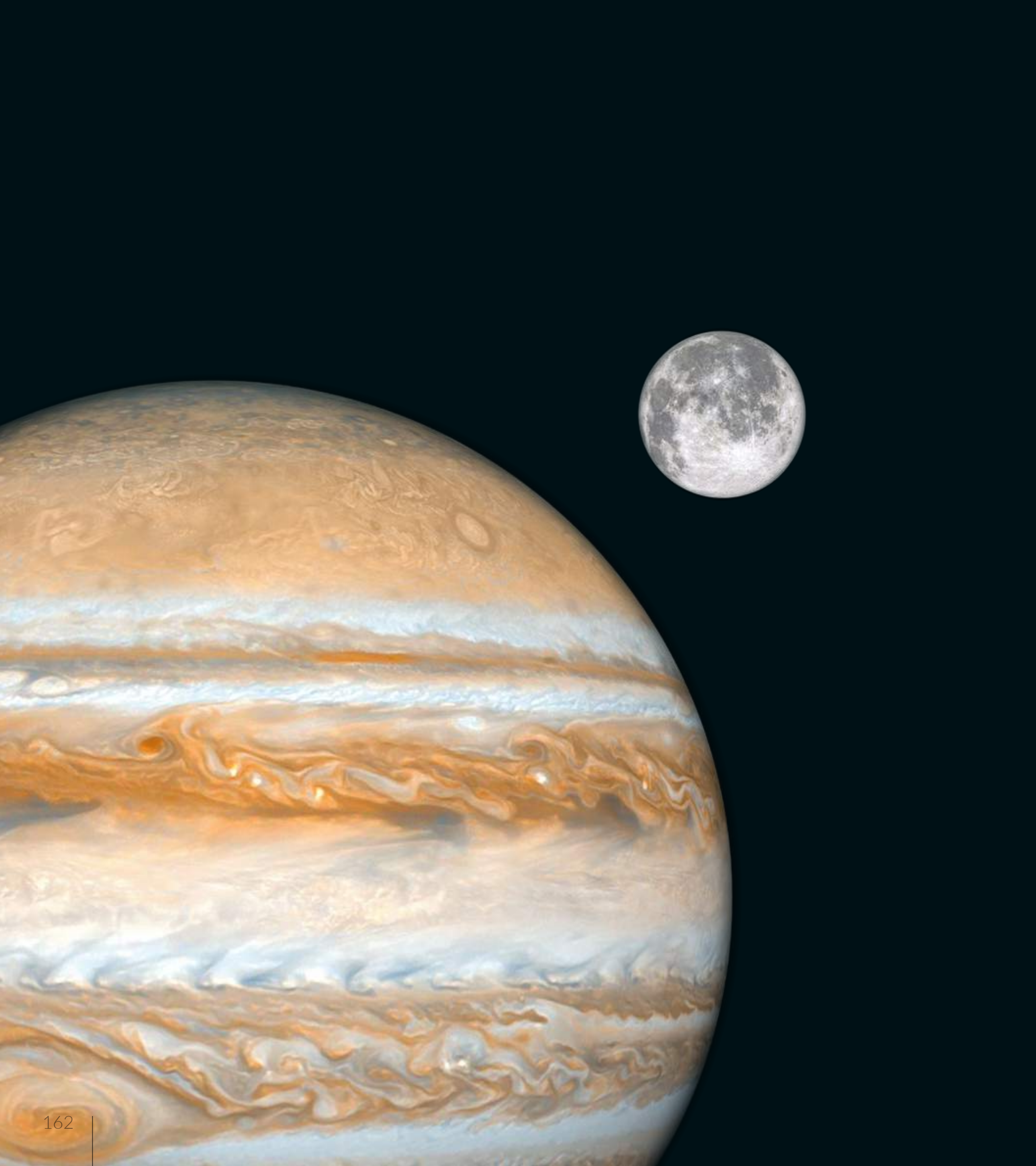

L'INCONTRO DI DUE MONDI

Immergiti in un mondo di design innovativo con modelli in vetro che riecheggiano fedelmente l'eleganza e la bellezza della versione in legno. La fusione perfetta di tradizione e modernità.

Immerse yourself in a world of innovative design with glass models that faithfully echo the elegance and beauty of the wooden version. The perfect fusion of tradition and modernity.



Visioni Incontro

Porta scorrevole esterno muro
Decoro **Waves** (LN01)
trasparente e sabbiato
Vetro extrachiaro
Lavorazione STS
Sistema di scorrimento **Cubo Fluid**
Maniglione MAN-Q20 inox satinato

Visioni Incontro

External wall sliding door
Waves decoration (LN01)
transparent and sandblasted
Extra-clear glass
STS workmanship
Cubo Fluid sliding system
MAN-Q20 satin stainless
steel handle

Sololegno **RS06**



Visioni Incontro
 Porta scorrevole interno muro **Paride**
 Decoro **Line** (LN02)
 trasparente e sabbiato
 Vetro bronzo
 Lavorazione STS - Telaio TN
 Maniglia VAS-T

Visioni Incontro
Sliding door inside the Paride wall
Transparent and sandblasted
Line decoration (LN02)
Bronze glass
STS workmanship - TN frame
VAS-T handle



Sololegno **RS05-i**

Visioni Incontro
 Porta monobattente **Style**
 Decoro **Laine** (LN03)
 trasparente e sabbiato
 Vetro extrachiaro
 Lavorazione STS - Telaio RSN
 Serratura Style M

Visioni Incontro
Style single door
Transparent and sandblasted
Laine decoration (LN03)
Extra-clear glass
STS workmanship - RSN frame
M Style Lock

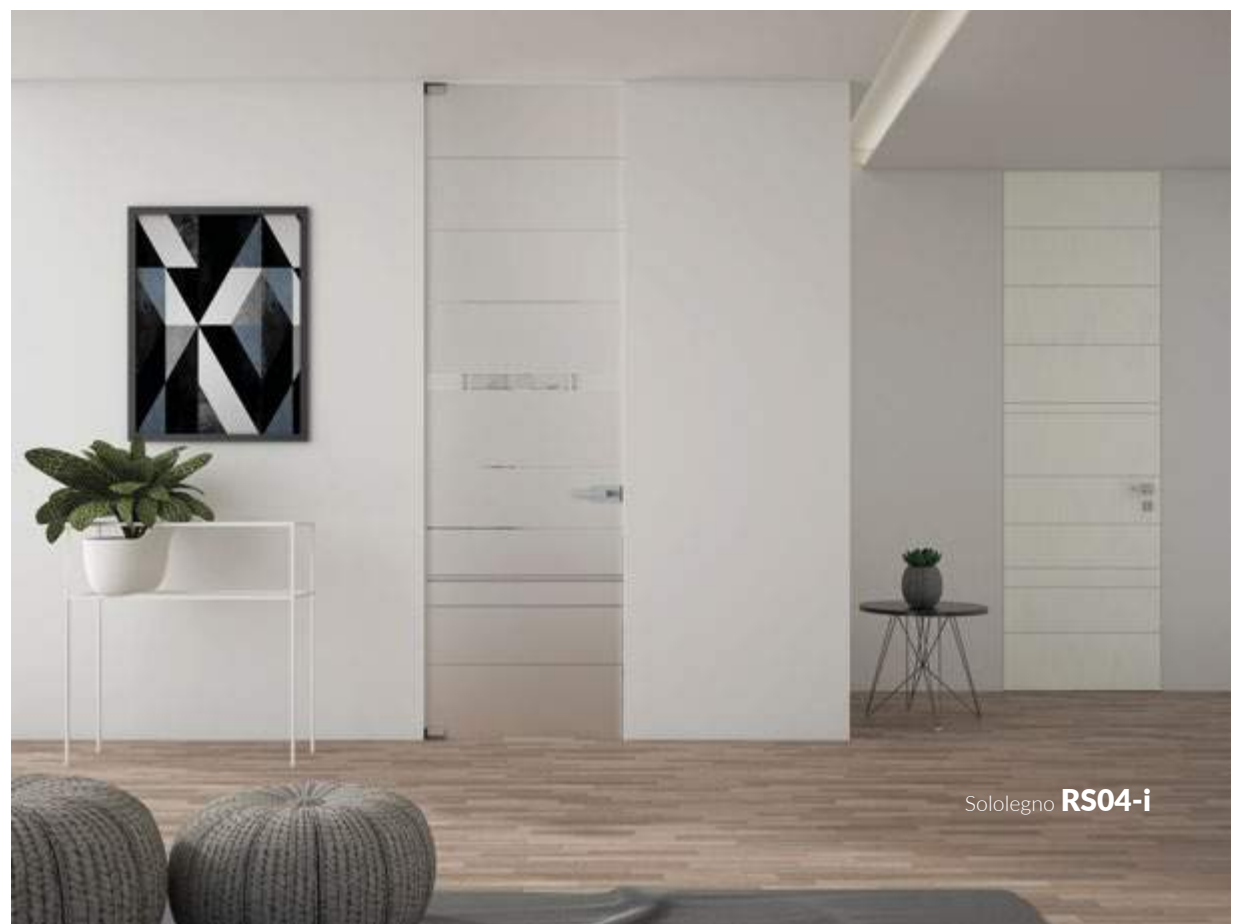

Sololegno **RS04-i**

Visioni Incontro

Porta scorrevole esterno muro
Decoro **V17-G** inciso
Vetro satinato grigio
Sistema di scorrimento **Evasione**
Maniglione MAN-Q20

Visioni Incontro

External wall sliding door
Engraved V17-G decoration
Gray satin glass
Scroll system **Evasione**
MAN-Q20 pull handle



Sololegno **FF22**



Sololegno **FF21**



Visioni Incontro

Porta scorrevole esterno muro
Decoro **V17-H** inciso vetro satinato bronzo
Sistema di scorrimento **Essenza**
Maniglione MAN-T116

Visioni Incontro

External wall sliding door
Engraved V17-H decoration Bronze satin glass
Sliding system **Essenza**
MAN-T116 pull handle









Sololegno **F167**



Visioni Incontro
Porta scorrevole interno muro **Paride**
Decoro **V16-AA** sabbiato
Vetro satinato extrachiaro
Telaio TA in alluminio bianco
Maniglia GSN

Visioni Incontro
Sliding door inside Paride wall
Sandblasted V16-AA decoration
Extra-clear satin glass
White aluminum TA frame
GSN handle

Visioni Incontro
Porta scorrevole esterno muro
Decoro **V17-J** inciso
Vetro satinato extrachiaro
Sistema di scorrimento **Puro Soft Close**
Maniglione MAN-T46

Visioni Incontro
External wall sliding door
Engraved V17-J decoration
Extra-clear satin glass
Puro Soft Close sliding system
MAN-T46 pull handle



Trix **VT11**



Trix **VT19**

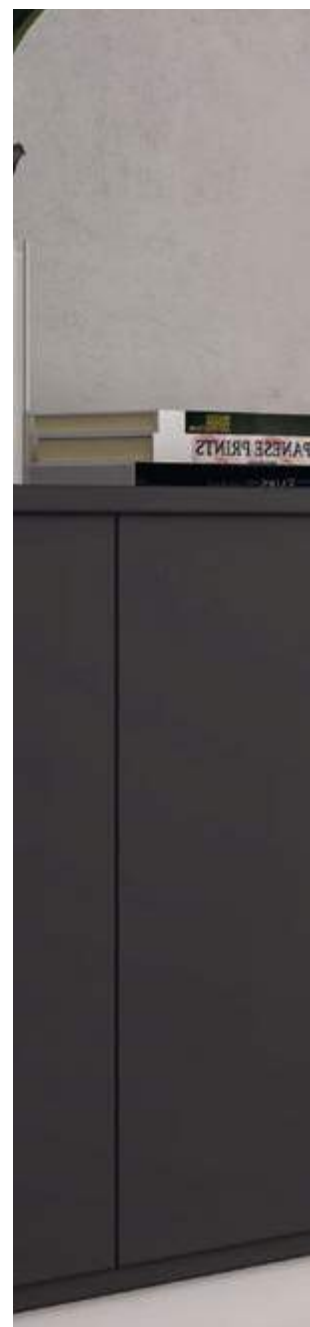
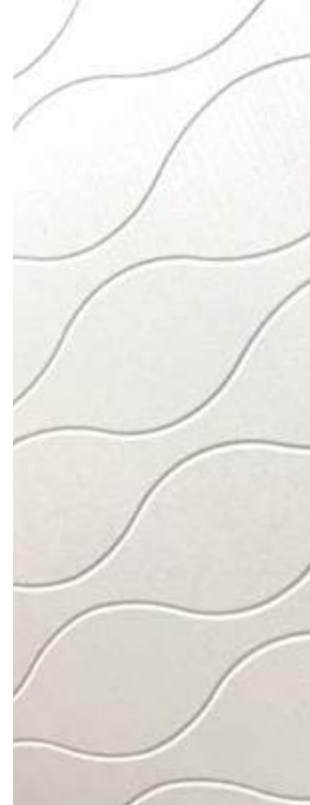

Visioni Incontro

Porta scorrevole esterno muro
 Decoro **V10-Q** sabbiato
 Vetro satinato extrachiaro
 Sistema di scorrimento **Cubo Fluid**
 Maniglione MAN-QS

Visioni Incontro

External wall sliding door
 Sandblasted V10-Q decoration
 Extra-clear satin glass
 Cubo Fluid slider system
 MAN-QS pull handle

Trix **GF40**

Visioni Incontro

Porta scorrevole esterno muro
 Decoro **V17-AF** inciso
 Vetro satinato grigio
 Sistema di scorrimento **Luna Soft Close**
 Maniglia VAS-T

Visioni Incontro

External wall sliding door
 Sandblasted V17-AF decoration
 Gray satin glass
 Luna Soft Close sliding system
 VAS-T handle



Vetri *Incontro* satinati incisi



V2-H



V2-L



V2-P



V2-T



V2-U



V2-W



V2-Z



V2-FF



V2-Y



V2-F2



V2-F4



V2-F7



V2-FA



V2-FC



V4-C



V17-A



V17-B



V17-C



V17-D



V17-E



V17-F



V17-AB



V17-G



V17-H

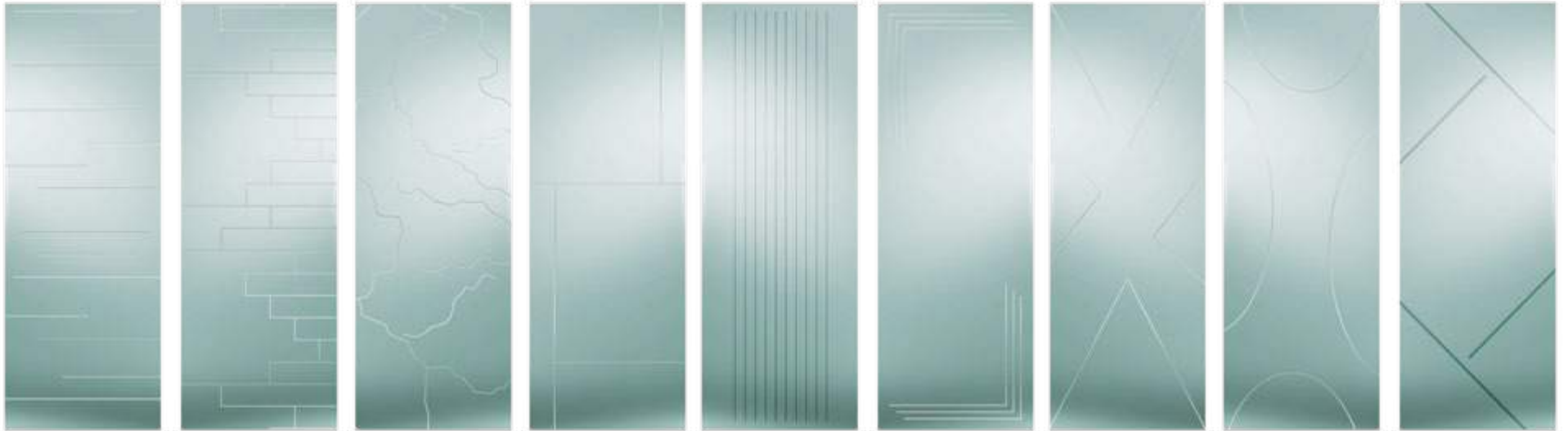

V17-I

V17-L

V17-M

V17-N

V17-J

V17-O

V17-P

V17-Q

V17-R

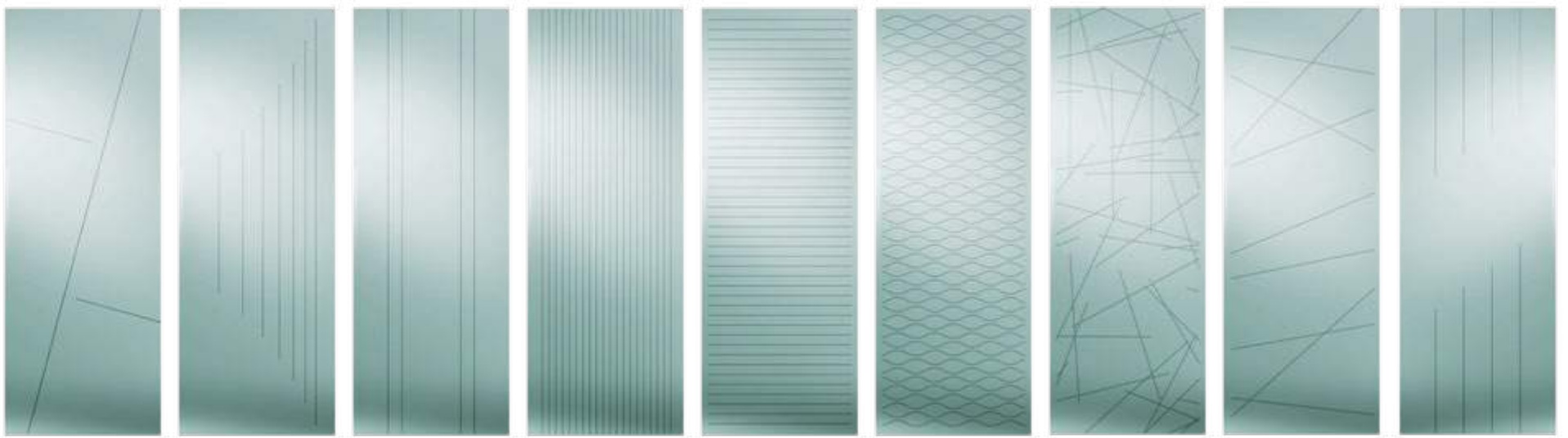

V17-S

V17-AA

V17-X

V17-AD

V17-AE

V17-AF

V17-AG

V17-K

V17-T



V17-U

V17-V

V17-W

V17-Y

V17-Z

V14-A

V14-B

V14-C

Vetri *Incontro* satinati sabbiati



V16-A



V16-G



V16-H



V16-E



V16-P



V16-Q



V16-O



V16-U



V16-J



V16-AO



V16-AP



V10-Q



V10-R



V10-S



V16-K



V16-V



V16-W



V16-X



V16-Y



V16-Z



V16-AA



V16-AB



V16-AC



V16-AD



V16-AE



V16-AF



V16-AG



V16-AH



V16-AI



V16-AL



V16-AM



V16-AN





IL VETRO NELLA SUA ESSENZA

Esplora l'eleganza senza tempo
dei nostri vetri: dal vetro satinato
al vetro trasparente, scopri
le nostre straordinarie lavorazioni
per dare vita alla tua visione.

*Explore the timeless elegance of our glass: from
satin glass to clear glass, discover our extraordinary
workmanship to bring your vision to life.*

Neutri

Disponibili su Visioni e Visioni Profile

I nostri vetri si declinano in cinque affascinanti tonalità. Dall'extrachiaro alla profondità del nero, passando per il classico float, il contemporaneo grigio e il creativo bronzo: scopri le sfumature che arricchiranno il tuo design con eleganza e stile.

Our glass comes in five fascinating shades. From extra-clear to the depth of black, passing through the classic float, the contemporary gray and the creative bronze: discover the shades that will enrich your design with elegance and style.



FLOAT TRASPARENTE



EXTRACHIARO TRASPARENTE



GRIGIO TRASPARENTE



BRONZO TRASPARENTE



DARK TRASPARENTE
● non disponibile su Visioni Profile



FLOAT SATINATO



EXTRACHIARO SATINATO



GRIGIO SATINATO



BRONZO SATINATO



DARK SATINATO
● non disponibile su Visioni Profile

Reflex

Disponibili su Visioni e Visioni Profile

Riflessi sofisticati e stile unico. Esplora la nostra selezione di vetri con effetto reflex, che catturano l'essenza della luce, e vetri con effetto specchio, per un tocco di glamour senza pari. Vetro non trasparente, caratterizzato da effetto riflettente e con effetto metallizzato superficiale. La riflessione della superficie aumenta al diminuire della luminosità dell'ambiente.

Sophisticated reflections and unique style. Explore our selection of glass with a reflex effect, which captures the essence of light, and glass with a mirror effect, for an unparalleled touch of glamour. Non-transparent glass, characterized by a reflective effect and a metallic surface effect. Surface reflection increases as the ambient brightness decreases.



REFLEX TRASPARENTE BIANCO



REFLEX TRASPARENTE GRIGIO



REFLEX TRASPARENTE BRONZO



REFLEX SATINATO BIANCO



REFLEX SATINATO GRIGIO



REFLEX SATINATO BRONZO



EFFETTO SPECCHIO

Hays

Disponibili su Visioni e Visioni Profile

Vetro trasparente con una leggera texture in rilievo. Il disegno è delicato e appena percettibile, per una porta delicata di altro livello estetico. Grande facilità di pulizia.

Transparent glass with a light raised texture. The design is delicate and barely perceptible, for a delicate door of a high aesthetic level. Great ease of cleaning.



HAYS EXTRACHIARO

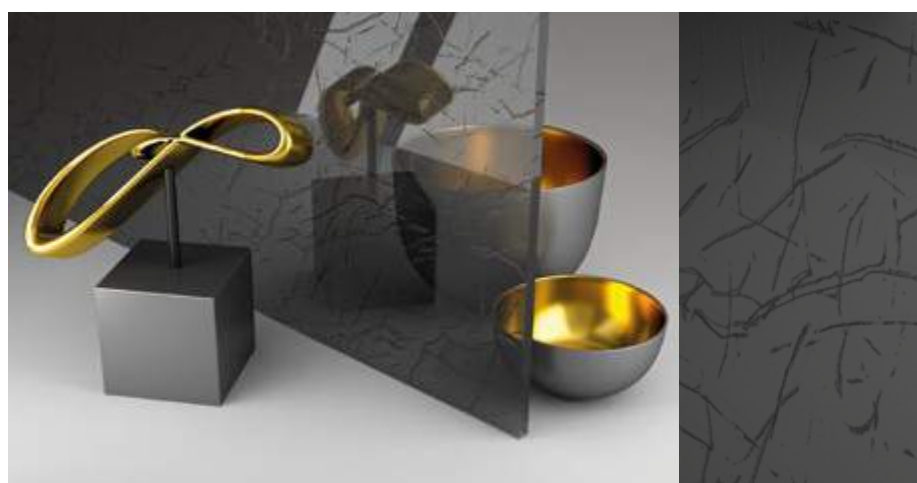

HAYS GRIGIO

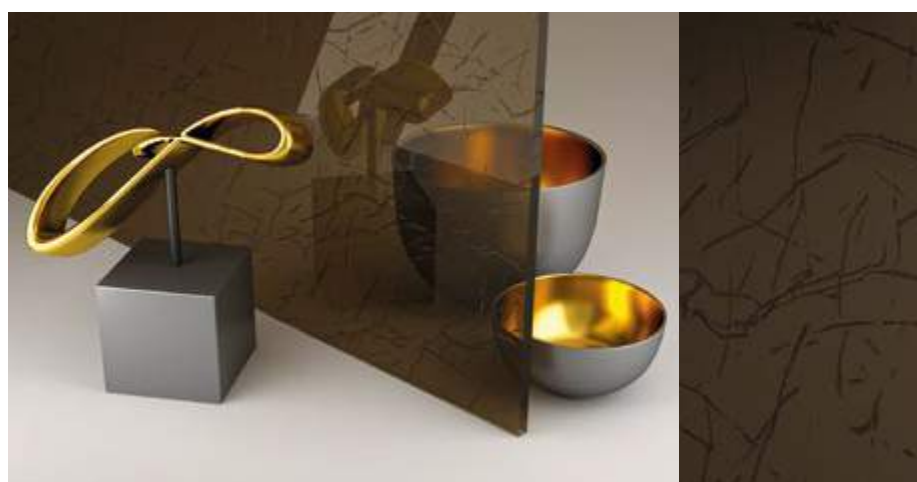

HAYS BRONZO

Kamyl

Disponibili su Visioni e Visioni Profile

È caratterizzato per la delicata texture, linee fitte ed irregolari disegnano una fine ragnatela sulla superficie della lastra. La superficie è perfettamente liscia al tatto, ed è disponibile con vetro extrachiaro, grigio e bronzo.

It is characterized by its delicate texture, thick and irregular lines draw a fine spider web on the surface of the slab. The surface is perfectly smooth to the touch, and is available with extra-clear, gray and bronze glass.

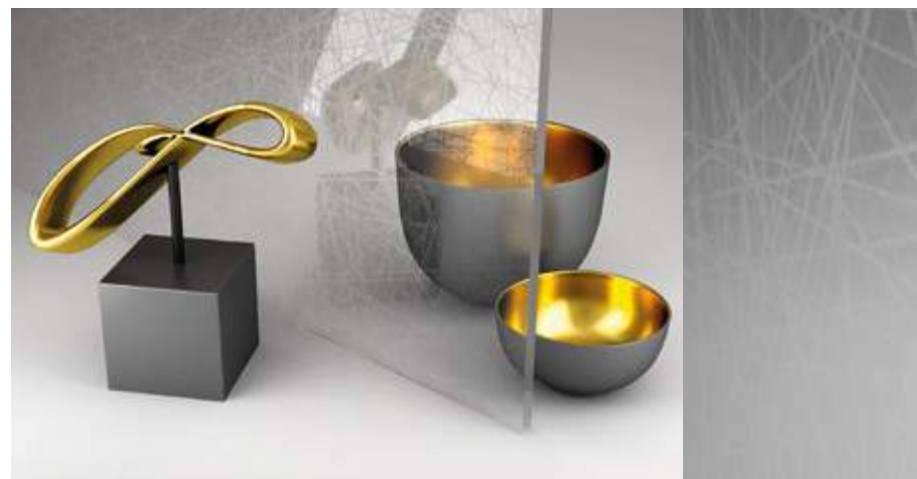

KAMYL EXTRACHIARO

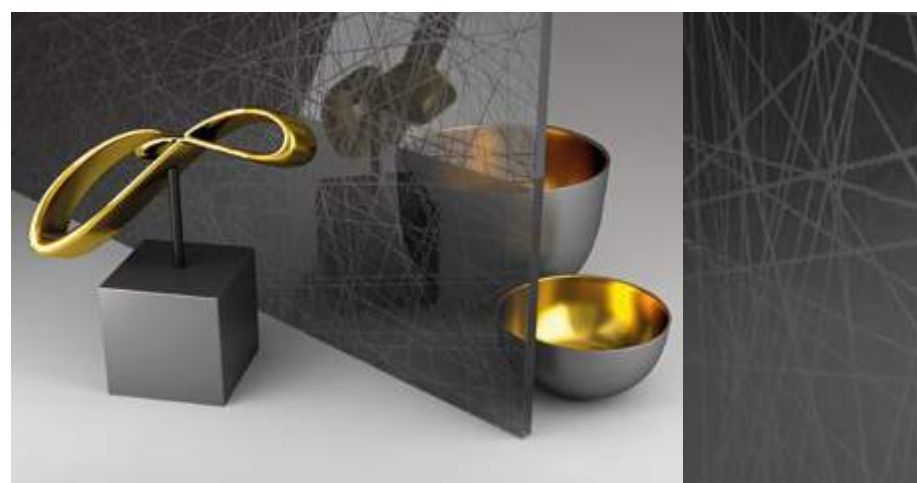

KAMYL GRIGIO



KAMYL BRONZO

Kostel

Disponibili su Visioni e Visioni Profile

Tanti piccoli puntini regolari presenti sulla superficie del vetro come una costellazione, rendono questo vetro elegante e raffinato. La superficie è liscia e l'incavo dei piccoli punti è appena percettibile per assicurare una facile e immediata pulizia. Disponibile con base vetro extrachiaro, grigio e bronzo.

Many small regular dots present on the surface of the glass like a constellation, make this glass elegant and refined. The surface is smooth and the indentation of the small dots is barely perceptible to ensure easy and immediate cleaning. Available with extra-clear, gray and bronze glass base.

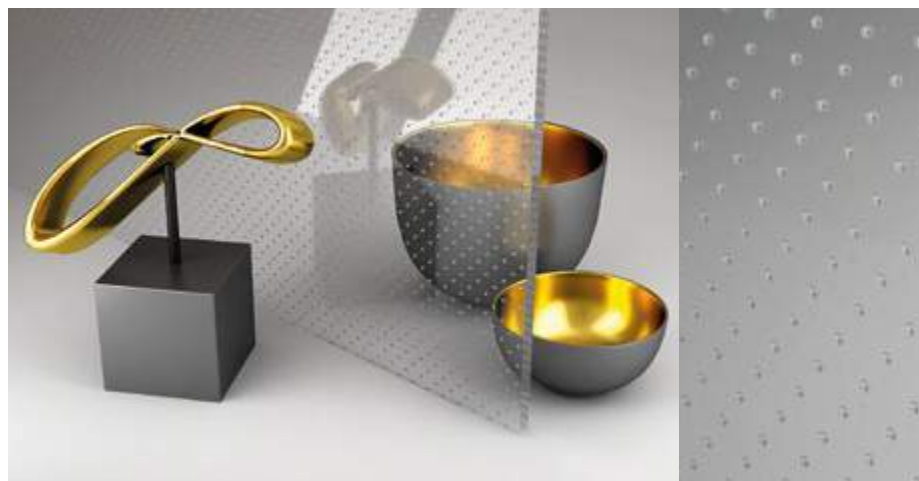

KOSTEL EXTRACHIARO

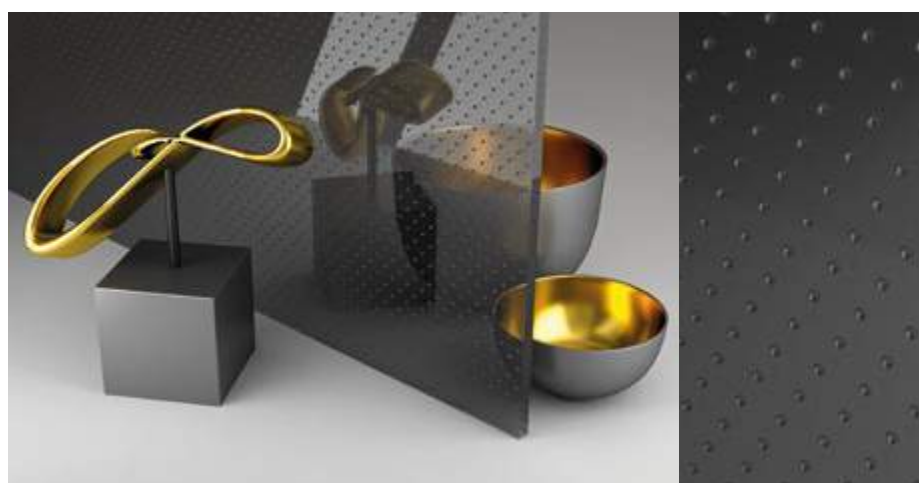

KOSTEL GRIGIO

KOSTEL GRIGIO

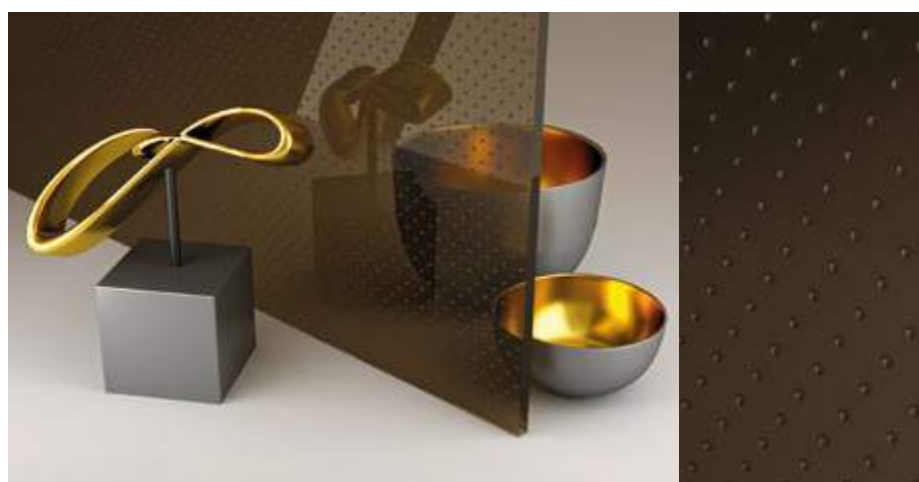

KOSTEL BRONZO

Stowe

Disponibili su Visioni e Visioni Profile

La texture, ha una finitura satinata opaca a bassissimo rilievo su fondo satinato. Un vetro unico, adatto per chi vuole discrezione senza rinunciare alla luce, ottimo alla resistenza alle impronte e soprattutto facile da pulire.

The texture has a matte satin finish with very low relief on a satin background. A unique glass, suitable for those who want discretion without sacrificing light, excellent resistance to fingerprints and above all easy to clean.

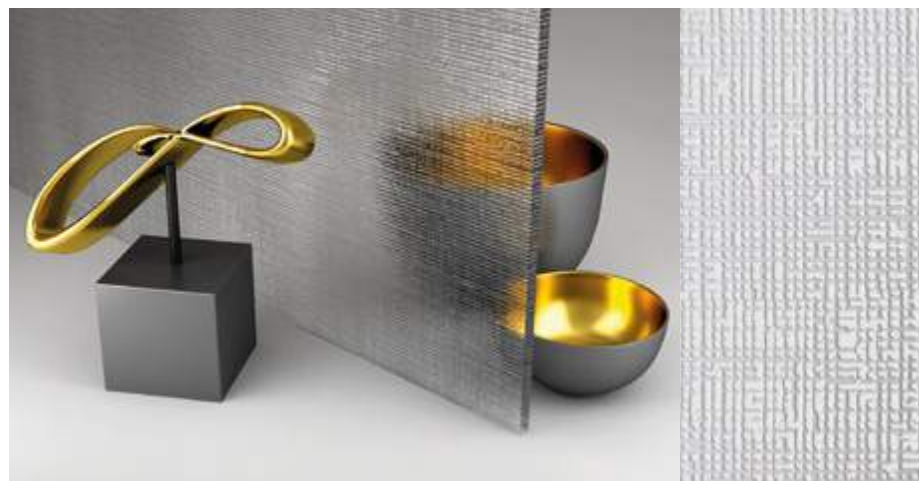

STOWE EXTRACHIARO



STOWE GRIGIO



STOWE BRONZO

Connection

Disponibili su Visioni e Visioni Profile

La serie di vetri "Connection" ha un cuore d'acciaio. Tre reti metalliche con trame differenti, accoppiate ad un vetro extrachiaro, grigio o bronzo, conferiscono alla porta un tocco personale dal design moderno e delicato.

The "Connection" glass series has a heart of steel. Three metal meshes with different textures, coupled with extra-clear, gray or bronze glass, give the door a personal touch with a modern and delicate design.

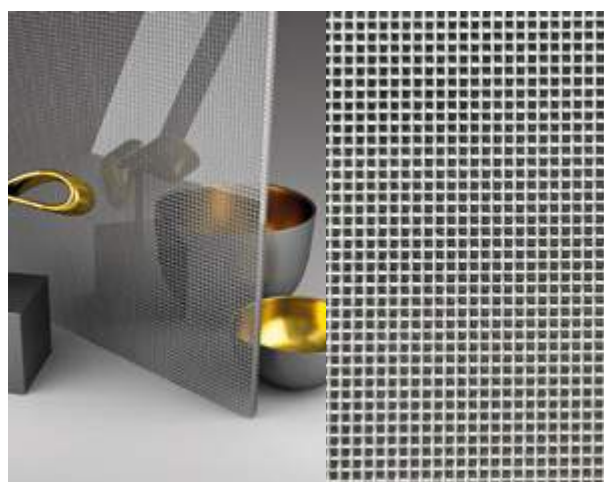

WIDE Connection EXTRACHIARO

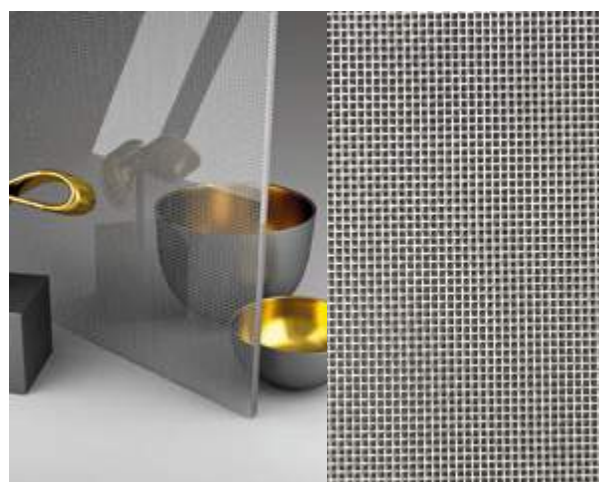

MEDIUM Connection EXTRACHIARO



LITE Connection EXTRACHIARO

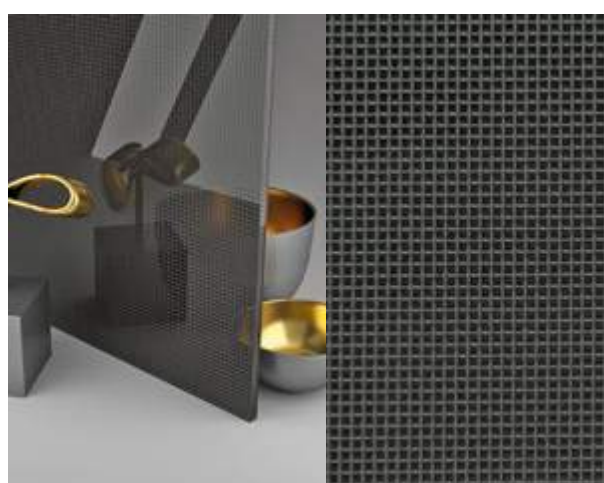

WIDE Connection GRIGIO

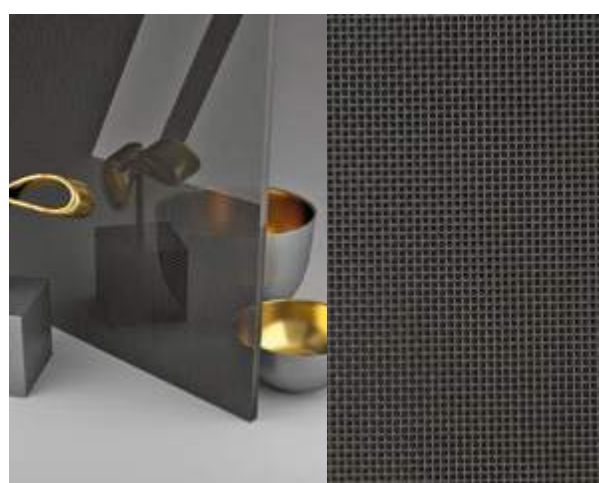

MEDIUM Connection GRIGIO



LITE Connection GRIGIO



WIDE Connection BRONZO



MEDIUM Connection BRONZO



LITE Connection BRONZO

Canvas

Disponibili su Visioni e Visioni Profile

La stoffa all'interno del vetro, per personalizzare le proprie porte con un design unico ed originale. Cinque trame e colori differenti, abbinata ad un vetro extrachiaro, capace di adattarsi ad un design ricercato ed unico.

The fabric inside the glass, to personalize your doors with a unique and original design. Five different textures and colours, combined with extra-clear glass, capable of adapting to a refined and unique design.

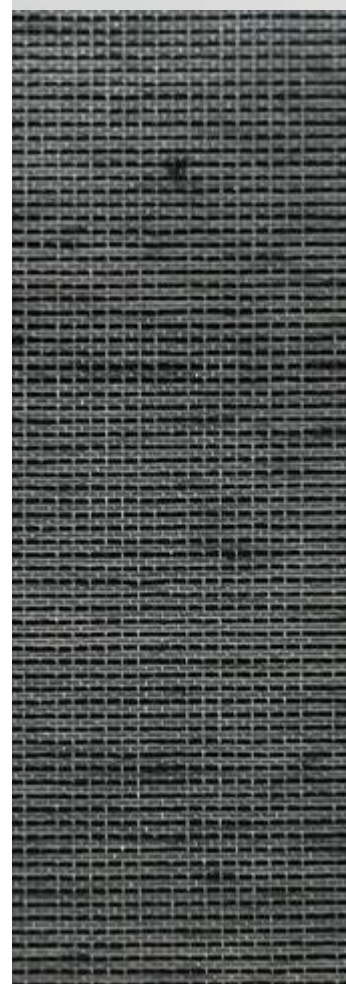
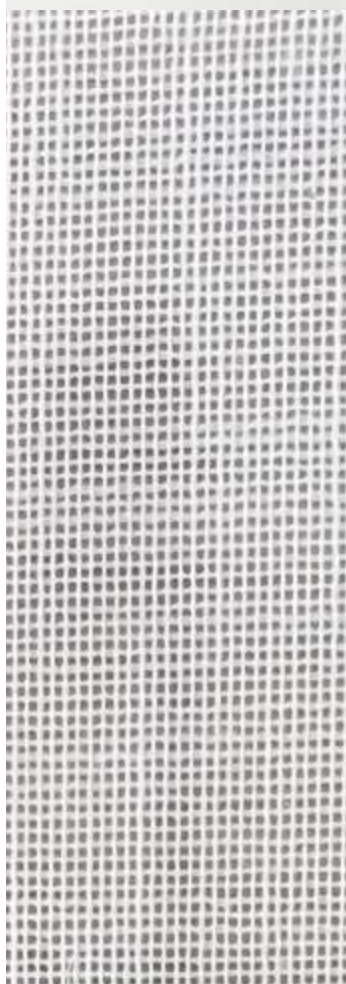
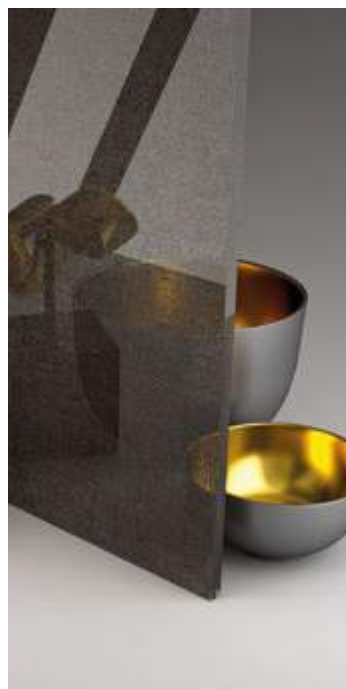

CREAM Canvas EXTRACHIARO

DESERT Canvas EXTRACHIARO

CHOCOLATE Canvas EXTRACHIARO

LIJNEN Canvas EXTRACHIARO

DARK Canvas EXTRACHIARO

AT

Vetro SATINATO da 10 mm e disegno trasparente
Vetro SATINATO da 10 mm e disegno trasparente

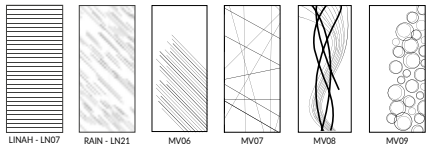

Lavorazione AT EXTRACHIARO



Lavorazione AT FLOAT



Lavorazione AT GRIGIO



Lavorazione AT BRONZO



Lavorazione AT DARK

ST

Vetro SABBBIATO da 10 mm con disegno trasparente
Vetro SABBBIATO da 10 mm con disegno trasparente

Disponibile anche in Satcolor ceramico / Also available in ceramic Satcolor

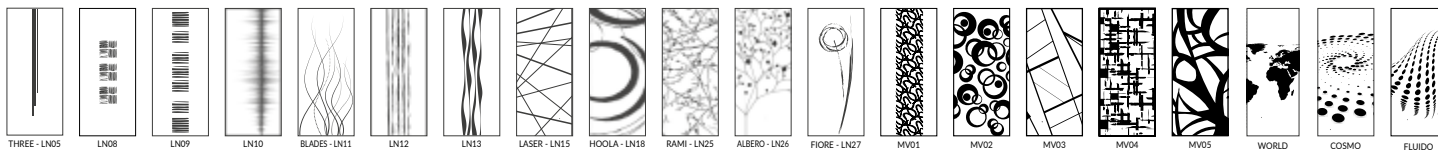

Lavorazione ST EXTRACHIARO



Lavorazione ST FLOAT



Lavorazione ST GRIGIO



Lavorazione ST BRONZO



Lavorazione ST DARK

AS

vetro SATINATO da 10 mm con disegno SABBBIATO e scavato su di un lato
 vetro satinato da 10 mm con disegno SABBBIATO e scavato su di un lato

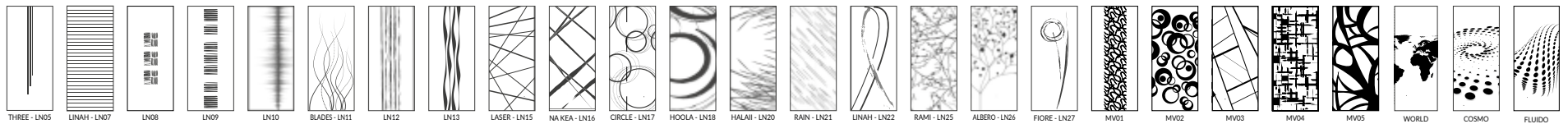

Lavorazione AD EXTRACHIARO



Lavorazione AD FLOAT



Lavorazione AD GRIGIO



Lavorazione AD BRONZO



Lavorazione AD DARK

TS

Vetro TRASPARENTE da 10 mm con disegno SABBBIATO su di un lato
 Vetro TRASPARENTE da 10 mm con disegno SABBBIATO su di un lato

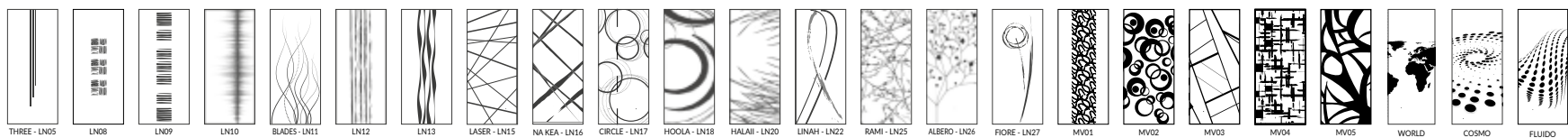

Lavorazione TS EXTRACHIARO



Lavorazione TS FLOAT



Lavorazione TS GRIGIO



Lavorazione TS BRONZO



Lavorazione TS DARK

STS

vetro SABBATO da 10 mm con disegno trasparente e sabbato
vetro SABBATO da 10 mm con disegno trasparente e sabbato

Disponibile anche nella versione Glass Chrome / Also available in the Glass Chrome version

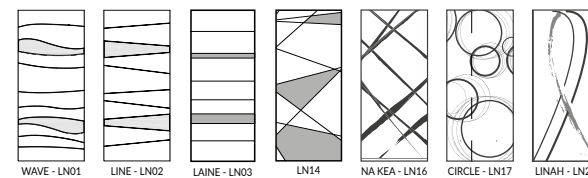

Lavorazione STS EXTRACHIARO



Lavorazione STS FLOAT



Lavorazione STS GRIGIO



Lavorazione STS BRONZO



Lavorazione STS DARK

TI

Vetro trasparente da 10 mm con incisioni opache
5+5 mm coupled glossy lacquered glass with opaque engravings

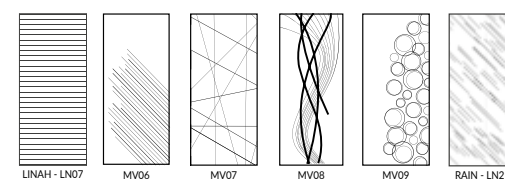

Lavorazione STS FLOAT



Lavorazione STS GRIGIO



Lavorazione STS BRONZO



Lavorazione STS DARK

MN

Disegno NEGATIVO a specchio effetto 3D
 NEGATIVE drawing mirrored 3D effect

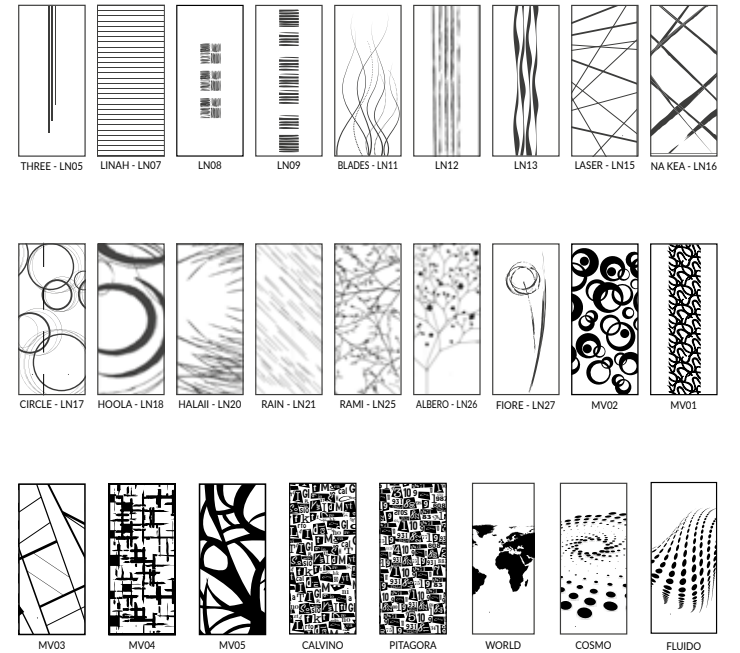
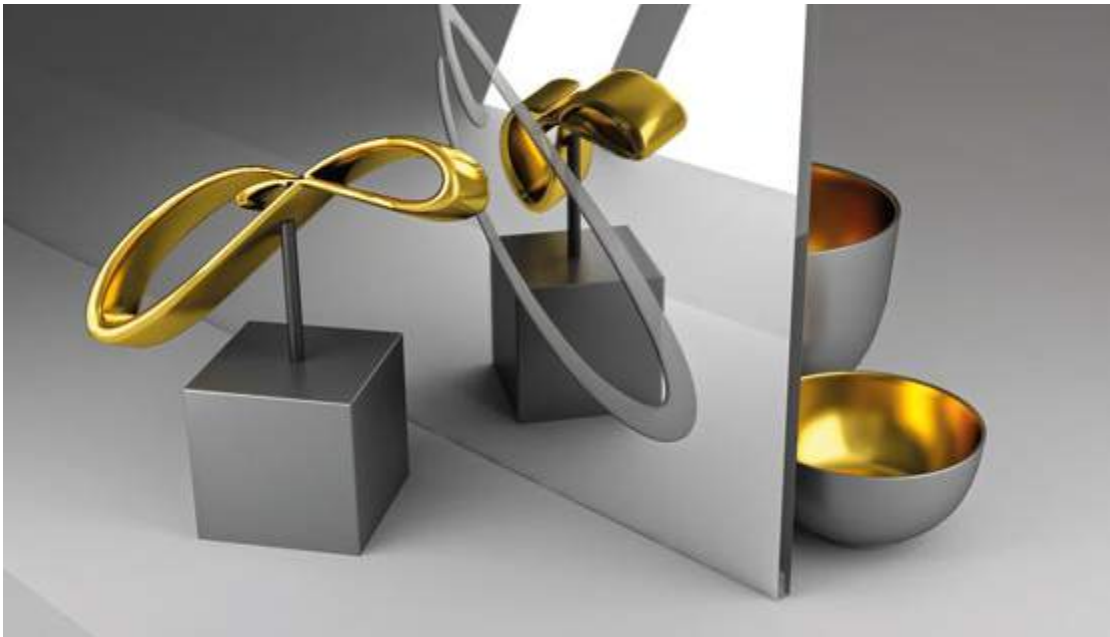

MP

Disegno POSITIVO a specchio effetto 3D
 POSITIVE design mirrored 3D effect

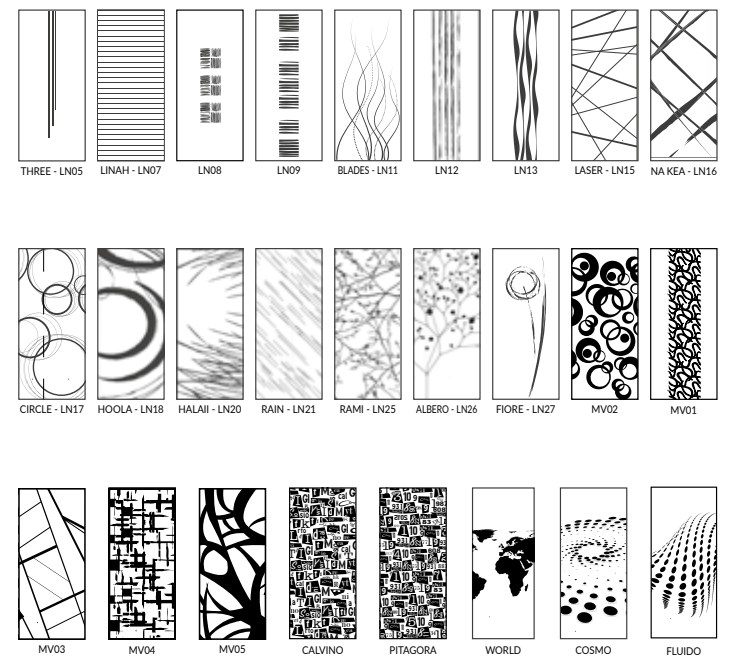

AD

Vetro satinato con disegno colorato SATCOLOR su lato esterno sp. 10 mm o colorato interno accoppiato 5+5
 Vetro satinato con disegno colorato SATCOLOR su lato esterno sp. 10 mm o colorato interno accoppiato 5+5

Vedi colori disponibili a pag. 198 

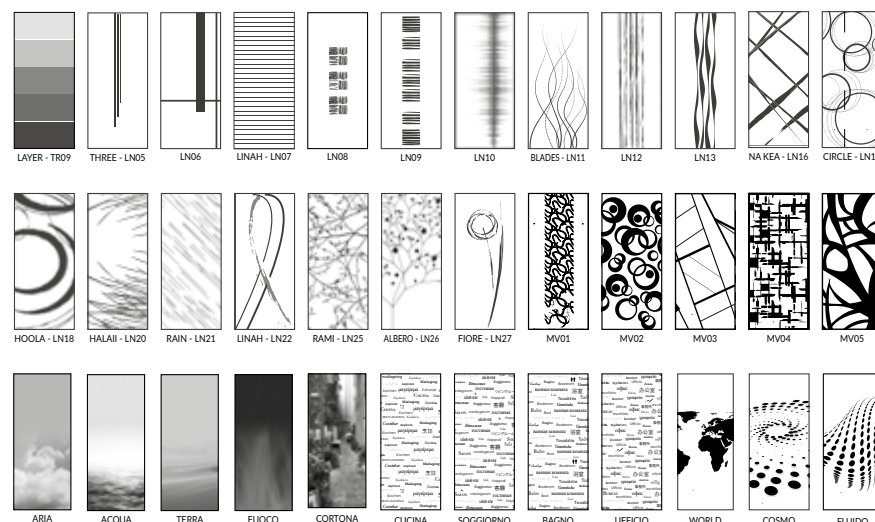
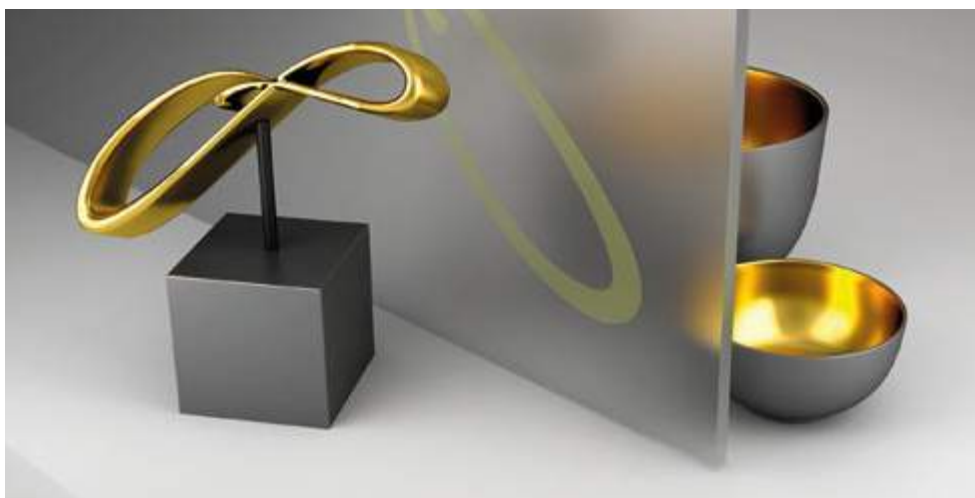

TD

Vetro accoppiato 5+5 mm trasparente con disegno SATCOLOR all'interno
 Vetro accoppiato 5+5 mm trasparente con disegno SATCOLOR all'interno

Vedi colori disponibili a pag. 198 

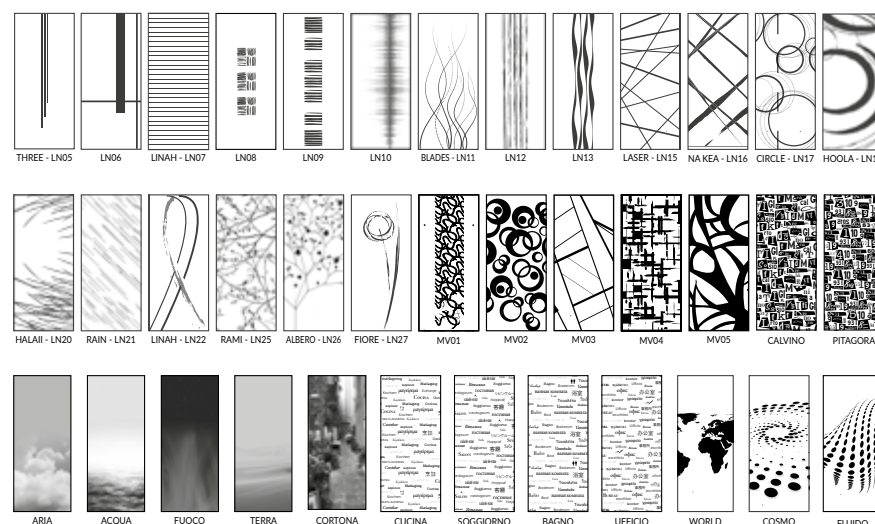
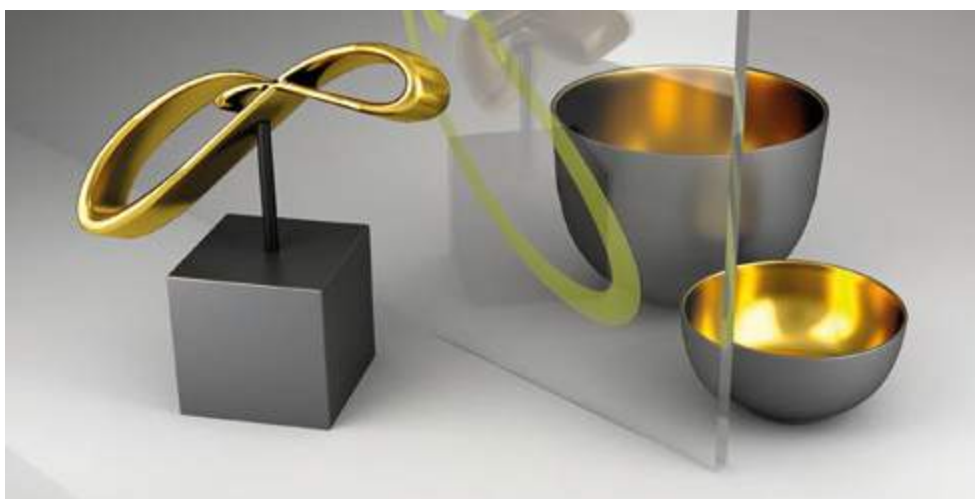

LB

Vetro Laccato Lucido accoppiato 5+5 mm con disegno SABBIAITO esterno su entrambi i lati
 5+5 mm coupled glossy lacquered glass with external SANDBLAST design on both sides



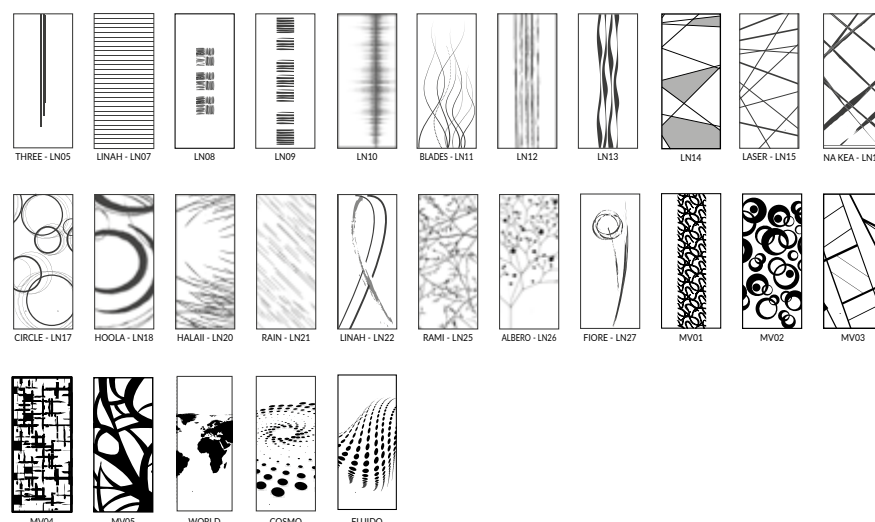







Vedi colori disponibili a pag. 196 













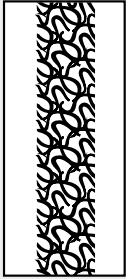

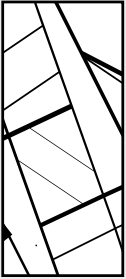
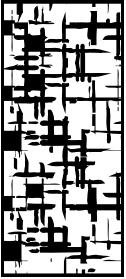

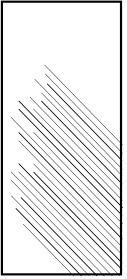
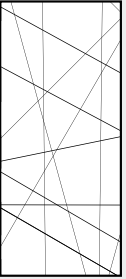
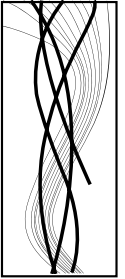
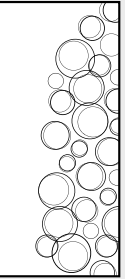

Lavorazioni

MODELLO		BASE VETRO				
	cod.	FLOAT (FL)	EXTRACHIARO (EX)	GRIGIO (GR)	BRONZO (BR)	DARK (DK)
VETRO TRASPARENTE	TR01	●	●	●	●	●
VETRO SATINATO	TR02	●	●	●	●	●
VETRO LACCATO LUCIDO	TR03		●			
VETRO LACCATO SATINATO	TR04		●			
VETRO SATCOLOR	TR05		●			
VETRO REFLEX SATINATO	TR06		●	●	●	
VETRO REFLEX TRASPARENTE	TR06/T		●	●	●	
EFFETTO SPECCHIO	TR07					
VETRO SATCOLOR SFUMATO	TR08		●			
VETRO SATCOLOR GRADAZIONI	TR09		●			
VETRO NEUTRAL	TR10	●	●	●	●	
VETRO SETA	TR11	●	●	●	●	
INCONTRO		FL	EX	GR	BR	DK
VETRO INCISO	V2 - V4 V14 - V17	●	●	●	●	
VETRO SABBIAATO	V10 - V16	●	●	●	●	

BASI VETRO	LAVORAZIONI										
	AS	AT	ST	STS	TS	TI	MN	MP	AD	TD	LB
FLOAT	●	●	●	●	●	●					
EXTRACHIARO	●	●	●	●	●	●			●	●	●
GRIGIO	●	●	●	●	●	●					
BRONZO	●	●	●	●	●	●					
DARK	●	●	●	●	●	●					

		LAYER - TR09	WAVE - LN01	LINE - LN02	LAINE - LN03	THREE - LN05	LN06	LINAH - LN07	LN08	LN09	LN10	BLADES - LN11
	AT							●				
	ST					●			●	●	●	●
	AS					●		●	●	●	●	●
	TS					●			●	●	●	●
	STS		●	●	●							
	TI							●				
	MN					●		●	●	●		●
	MP					●		●	●	●		●
	AD	●				●	●	●	●	●	●	●
	TD					●	●	●	●	●	●	●
	LB					●		●	●	●	●	●

LN12	LN13	LN14	LASER - LN15	NA KEA - LN16	CIRCLE - LN17	HOOLA - LN18	HALAII - LN20	RAIN - LN21	LINAH - LN22	RAMI - LN25	ALBERO - LN26	FIORE - LN27
								●				
●	●		●			●				●	●	●
●	●		●	●	●	●	●	●	●	●	●	●
●	●		●	●	●	●	●		●	●	●	●
		●		●	●				●			
								●				
●	●		●	●	●	●	●	●		●	●	●
●	●		●	●	●	●	●	●	●	●	●	●
●	●		●	●	●	●	●	●	●	●	●	●
●	●		●	●	●	●	●	●	●	●	●	●
●	●	●	●	●	●	●	●	●	●	●	●	●

		 MV01	 MV02	 MV03	 MV04	 MV05	 MV06	 MV07	 MV08	 MV09	 ARIA TM01-A
	AT						●	●	●	●	
	ST	●	●	●	●	●					
	AS	●	●	●	●	●					
	TS	●	●	●	●	●					
	STS										
	TI						●	●	●	●	
	MN	●	●	●	●	●					
	MP	●	●	●	●	●					
	AD	●	●	●	●	●					●
	TD	●	●	●	●	●					●
	LB	●	●	●	●	●					

FUOCO TM01-F	ACQUA TM01-H	TERRA TM01-T	CORTONA TM02-A	CUCINA TM03-A	SOGGIORNO TM03-B	BAGNO TM03-C	UFFICIO TM03-D	CALVINO RF04	PITAGORA RF05	WORLD RF06	COSMO RF07	FLUIDO RF08
										●	●	●
										●	●	●
										●	●	●
										●	●	●
										●	●	●
									●	●	●	●
									●	●	●	●
●	●	●	●	●	●	●	●	●	●	●	●	●
●	●	●	●	●	●	●	●	●	●	●	●	●
										●	●	●

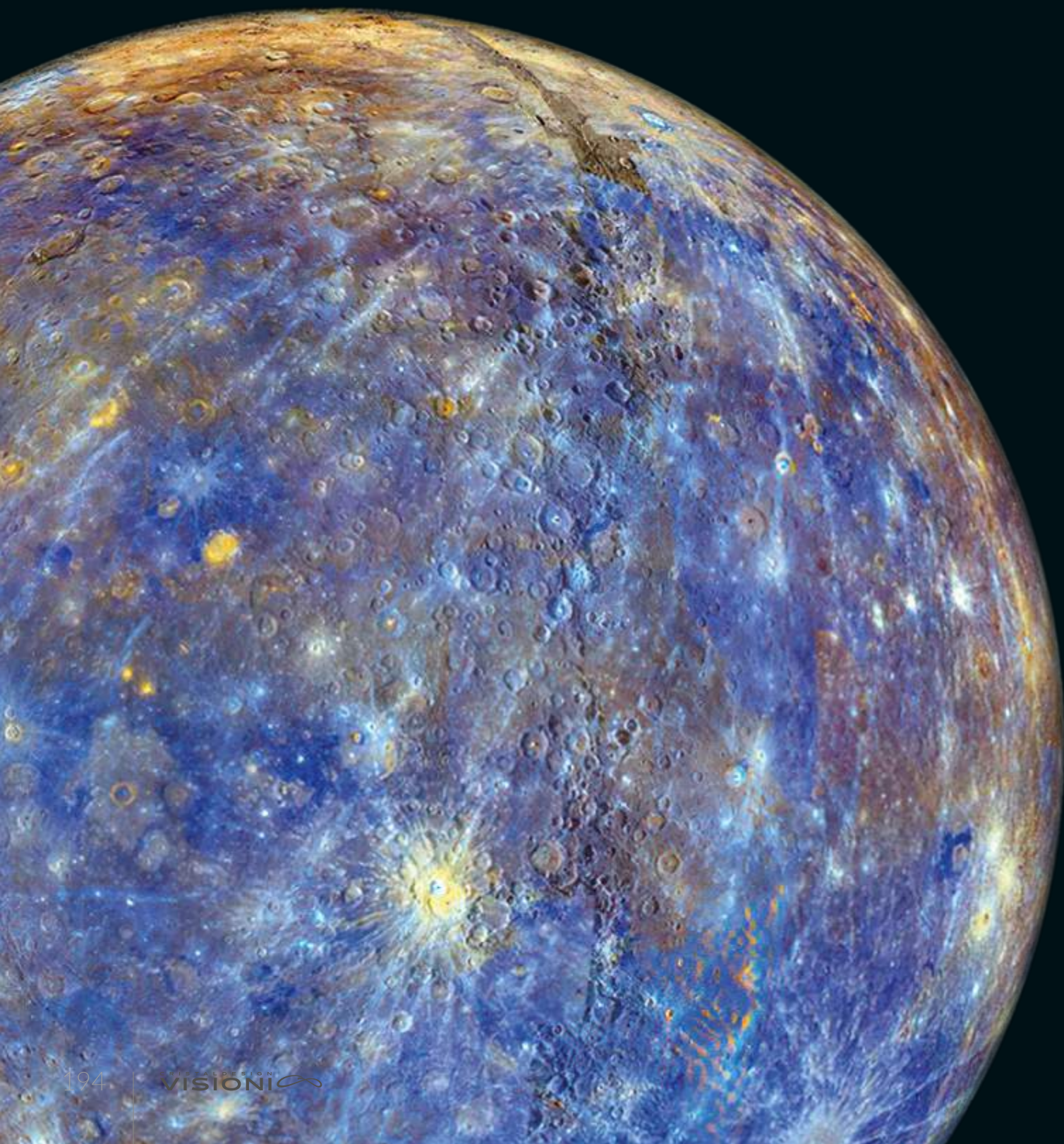

COLORI E PROFILI

La Poesia dei Colori.

Scopri come il vetro ed i profili in alluminio possono trasformare l'ordinario in straordinario. Scegli tra una vasta gamma di colori per definire il tuo stile.

The Poetry of Colors. Discover how glass and aluminum profiles can transform the ordinary into the extraordinary. Choose from a wide range of colors to define your style.

Laccati lucidi

La laccatura del vetro viene eseguita sulla superficie interna di 2 lastre di vetro temprato dello spessore di 5 mm, successivamente vengono accoppiate, garantendo l'inalterabilità dei colori nel tempo. La lavorazione viene eseguita esclusivamente su vetri extrachiari per non alterare il colore e rendere la massima brillantezza superficiale (100 gloss).

The glass lacquering is carried out on the internal surface of 2 sheets of tempered glass with a thickness of 5 mm, which are then coupled, guaranteeing the unalterability of the colors over time. The processing is carried out exclusively on extra-clear glass so as not to alter the color and provide maximum surface shine (100 gloss).



LACCATO lucido BIANCO



LACCATO lucido PERLA



LACCATO lucido ANTRACITE



LACCATO lucido NERO



LACCATO lucido TORTORA



LACCATO lucido SALVIA



LACCATO lucido TERRA



LACCATO lucido MELOGRANO



LACCATO lucido CIELO



LACCATO lucido LIME



LACCATO lucido PORPORA



LACCATO lucido MALVA

Laccati satinati

Come per la laccatura lucida, anche per il satinato viene eseguita sulla superficie interna di 2 lastre di vetro temprato e satinato dello spessore di 5 mm. Successivamente vengono accoppiate, lasciando il lato satinato delle due lastre all'esterno. La lavorazione viene eseguita esclusivamente su vetri extrachiarissimi per non alterare il colore, al tatto risulterà una superficie vellutata.

As for glossy lacquering, also for satin lacquering it is carried out on the internal surface of 2 sheets of tempered and satin glass with a thickness of 5 mm. They are subsequently coupled, leaving the satin side of the two sheets on the outside. The processing is carried out exclusively on extra-clear glass so as not to alter the colour, it will result in a velvety surface to the touch.



LACCATO satinato BIANCO



LACCATO satinato PERLA



LACCATO satinato ANTRACITE



LACCATO satinato NERO



LACCATO satinato TORTORA



LACCATO satinato SALVIA



LACCATO satinato TERRA



LACCATO satinato MELOGRANO



LACCATO satinato CIELO



LACCATO satinato LIME



LACCATO satinato PORPORA



LACCATO satinato MALVA

Satcolor satinati

Il vetro utilizzato è uno stratificato 5+5 mm e permette di avere una lastra colorata senza perdere l'effetto di trasparenza e di luce. La colorazione è effettuata sulla superficie satinata interna della lastra, in questo modo sarà possibile pulire l'anta senza andare a intaccare il decoro, che rimarrà inalterato nel tempo.

The glass used is a 5+5 mm laminate and allows you to have a colored sheet without losing the effect of transparency and light. The coloring is carried out on the internal satin surface of the slab, in this way it will be possible to clean the door without damaging the decoration, which will remain unchanged over time.



SATCOLOR trasparente
BIANCO



SATCOLOR trasparente
PERLA / ARIAN / MOON



SATCOLOR trasparente
TORTORA / SOHARA / LIGHT GREY



SATCOLOR trasparente
ANTRACITE



SATCOLOR trasparente
NERO



SATCOLOR trasparente
CIELO / SAMOA



SATCOLOR trasparente
LIME



SATCOLOR trasparente
SALVIA



SATCOLOR trasparente
PORPORA



SATCOLOR trasparente
DENEH



SATCOLOR trasparente
MALVA



SATCOLOR trasparente
STONE / BLUE MARINE



SATCOLOR trasparente
GOLD



SATCOLOR trasparente
ANTIQUÉ BRASS



SATCOLOR trasparente
DARK BRONZE



SATCOLOR trasparente
AKENAR



SATCOLOR trasparente
TERRA / DOON



SATCOLOR trasparente
BROWN

PROFILI anodizzati Spazzolati

Sezione dedicata alle finiture disponibili dei profili in alluminio. Quattro le finiture nella versione spazzolata: lucentezza e riflessi striati le loro caratteristiche principali.

Section dedicated to the available finishes of the aluminum profiles. There are four finishes in the brushed version: shine and streaked reflections are their main characteristics.



PROFILO spazzolato
ALLUMINIO



PROFILO spazzolato
BRONZO



PROFILO spazzolato
GRAFITE



PROFILO spazzolato
BLACK

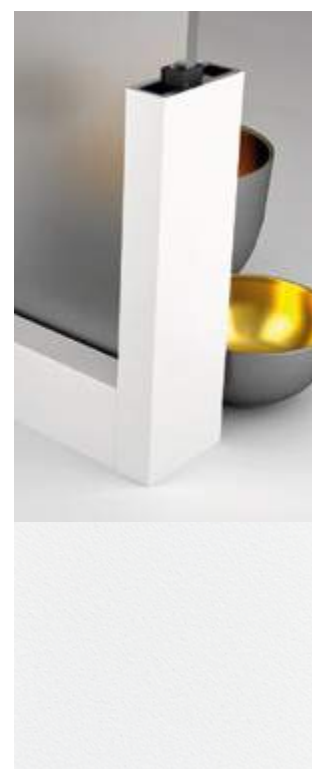

PROFILO verniciato
WHITE BAY



PROFILO verniciato
ARIAN



PROFILO verniciato
SAMOA



PROFILO verniciato
BLUE MARINE

PROFILI Verniciati

16 le tonalità disponibili nella versione verniciata dei profili: colori di tendenza abbinabili ad un vetro dello stesso colore per un ambiente elegante e raffinato.

16 shades available in the painted version of the profiles: trendy colors that can be combined with glass of the same color for an elegant and refined environment.



PROFILO verniciato
MOON

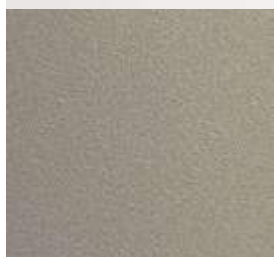

PROFILO verniciato
SOHARA



PROFILO verniciato
LIGHT GREY



PROFILO verniciato
STONE

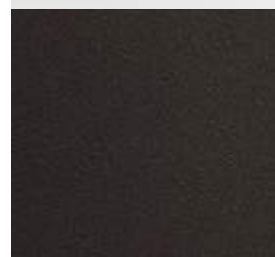

PROFILO verniciato
BLANE



PROFILO verniciato
GOLD

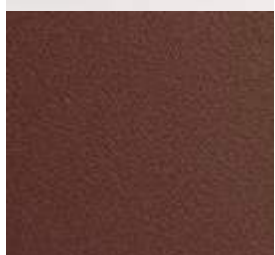

PROFILO verniciato
DENE B

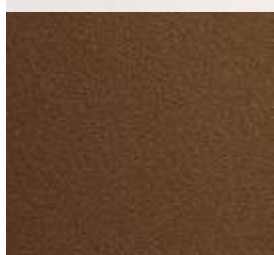

PROFILO verniciato
ANTIQU E BRASS

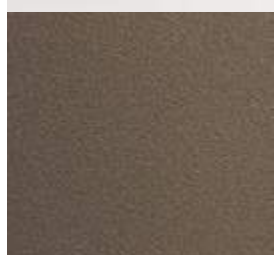

PROFILO verniciato
AKENAR

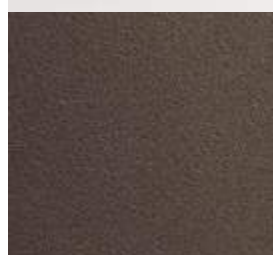

PROFILO verniciato
DARK BRONZE

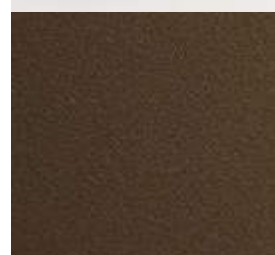

PROFILO verniciato
DONN

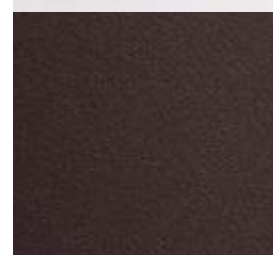

PROFILO verniciato
BROWN



SERRATURE, MANIGLIERIA E ACCESSORI

Porte in vetro perfette.
Trova l'accessorio ideale
per la tua porta in vetro.
Dalle cerniere alle maniglie,
trasforma la tua esperienza di apertura.

*Perfect Glass Doors. Find the ideal accessory
for your glass door. From hinges to handles,
transform your opening experience.*

FINITURE DISPONIBILI

AVAILABLE FINISHES

Tutt'altro che optional!
Maniglie, serrature e cerniere sono punti nevralgici delle porte "Visioni". Funzionali, robusti ed esteticamente essenziali gli accessori che compongono le nostre realizzazioni sono quel valore aggiunto che rende ogni apertura in vetro un inno alla condivisione e un invito al dialogo.

Anything but optional! Handles, locks and hinges are basic items of 'Vision doors'. The accessories of our creations are functional, strong and aesthetically essential. They are the hallmarks that make every glass opening an ode to sharing and a suggestion to the dialogue.



ANN

ALLUMINIO
ANODIZZATO



IS

INOX
SATINATO



GBK

ALLUMINIO
ANODIZ. NERO



VBI

VERNICIATO
BIANCO



GGR

ALLUMINIO
ANODIZ. GRAFITE



VN

VERNICIATO
NERO



GBR

ALLUMINIO
ANODIZ. BRONZO



VS

VERNICIATO
COL. SPECIALI

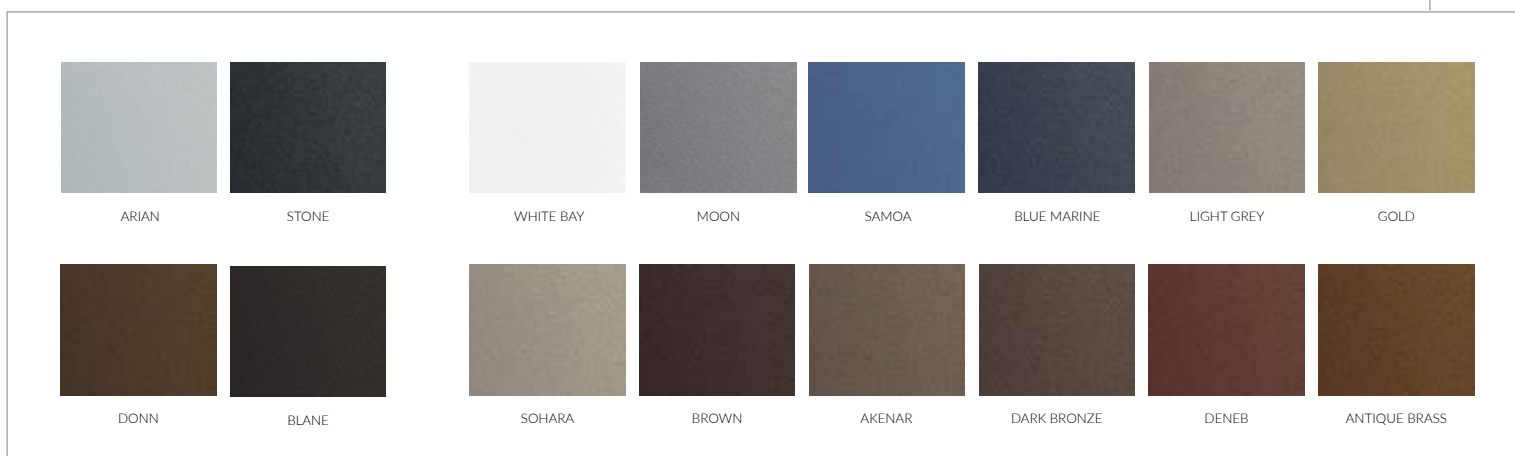

Maniglia per scorrevoli (di serie)
Sliding handle (standard)

MAN-PR28
h 280 mm

ANN
ALLUMINIO ANODIZZATO

GBK
ALLUMINIO ANODIZZATO NERO

GGR
ALLUMINIO ANODIZZATO GRAFITE

GBR
ALLUMINIO ANODIZZATO BRONZO

VBI
VERNICIATO BIANCO

VS
VERNICIATO COL. SPECIALI



Maniglia per scorrevoli e a battente
Sliding handle (standard)

SV-M
h 280 mm

ANN
ALLUMINIO ANODIZZATO

GBK
ALLUMINIO ANODIZZATO NERO

GGR
ALLUMINIO ANODIZZATO GRAFITE

GBR
ALLUMINIO ANODIZZATO BRONZO

VBI
VERNICIATO BIANCO

VS
VERNICIATO COL. SPECIALI



Maniglia per porte a battente (di serie)
Swing door handle (standard)



SM
h 60 mm

ANN
ALLUMINIO ANODIZZATO

GBR
ALLUMINIO ANODIZZATO BRONZO

VBI
VERNICIATO BIANCO

GBK
ALLUMINIO ANODIZZATO NERO

GGR
ALLUMINIO ANODIZZATO GRAFITE

VS
VERNICIATO COL. SPECIALI

Serratura orizzontale per porte a battente
Horizontal lock for swing doors



SO-M
b 180 mm x h 60 mm



SO-CH
b 180 mm x h 60 mm



SO-LO
b 180 mm x h 60 mm

ANN
ALLUMINIO ANODIZZATO

GGR
ALLUMINIO ANODIZZATO GRAFITE

GBK
ALLUMINIO ANODIZZATO NERO

GBR
ALLUMINIO ANODIZZATO BRONZO

VBI
VERNICIATO BIANCO

VS
VERNICIATO COL. SPECIALI

Serratura per porte scorrevoli e a battente
Lock for sliding and swing doors

SV-LO
h 280 mm

ANN
ALLUMINIO ANODIZZATO

GBK
ALLUMINIO ANODIZZATO NERO

GGR
ALLUMINIO ANODIZZATO GRAFITE

GBR
ALLUMINIO ANODIZZATO BRONZO

VBI
VERNICIATO BIANCO

VS
VERNICIATO COL. SPECIALI



SV-CH
h 280 mm

ANN
ALLUMINIO ANODIZZATO

GBK
ALLUMINIO ANODIZZATO NERO

GGR
ALLUMINIO ANODIZZATO GRAFITE

GBR
ALLUMINIO ANODIZZATO BRONZO

VBI
VERNICIATO BIANCO

VS
VERNICIATO COL. SPECIALI



Serratura per porta a battente **Athena**
Athena swing door lock



SER-ATM



SER-ATC



SER-ATN



Cerniera per porte **Athena**
Hinge Athena version



CV-AT



Serratura per porta a battente **Style**
Style swing door lock



SER-M

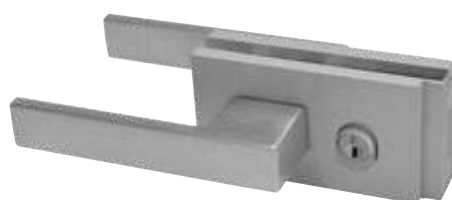

SER-MC



SER-MN



Cerniera per porte **Style**
Hinge Style version



CV-SB



Serratura per porte scorrevoli
Sliding door lock



GSC



GSY



GSN



Serratura magnetica a filo
per porta a battente **Style**
Style magnetic wire lock for swing doors



MVS



Cerniere per porte a ventola **Harys**
Swing door hinges



CV-CS

Cerniera meccanica
versione **EVO**
Mechanic hinge EVO version



CV-CO

Cerniera oleodinamica
versione **EVO1**
Hydraulic hinge EVO1 version



Cerniere per porte a bilico pivot **Nemesi**
Pivot pivot door hinges



CO-PS

Cerniera a bilico oleodinamica
Hydraulic hinge pivot



VAS-T
Vaschetta tonda ø 60 mm
Round handle ø 60 mm

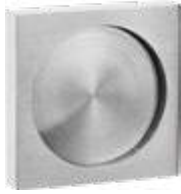

VAS-Q
Vaschetta quadra h 52 mm
Square handle h 52 mm



VAS-TS
Vaschetta tonda ø 50 mm
Round handle ø 50 mm



VAS-QS
Vaschetta quadra h 50 mm
Square handle h 50 mm



POM-T
Pomolo tondo ø 25 mm
Round knob ø 25 mm



POM-Q
Pomolo quadro h 25 mm
Square knob h 25 mm



Serratura magnetica a filo
per porta scorrevole
Magnetic wire lock for sliding door



MGS

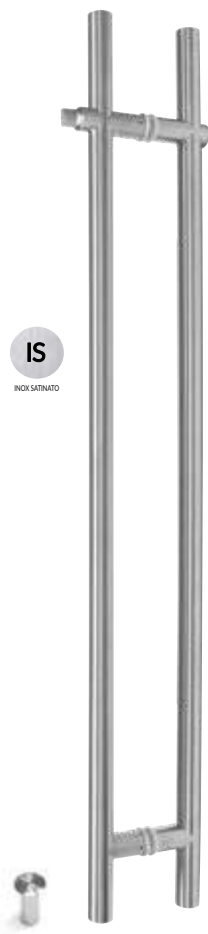

MAN-TK
h 1250 mm

Maniglione tondo con chiave
Round handle with key



MAN-QS
h 470 mm

Maniglione quadro
sagomato
Shaped square handle



MAN-T46
h 460 mm

MAN-T66
h 660 mm
MAN-T116
h 1160 mm

Maniglione tondo
Round handle



MAN-Q46
h 460 mm

MAN-Q66
h 660 mm
MAN-Q116
h 1160 mm

Maniglione quadro
Square handle



MAN-QC
h 500 mm

Maniglione
quadro curvo
Curved square handle



MAN-T20
h 260 mm
MAN-T30
h 300 mm

Maniglione tondo
Round handle

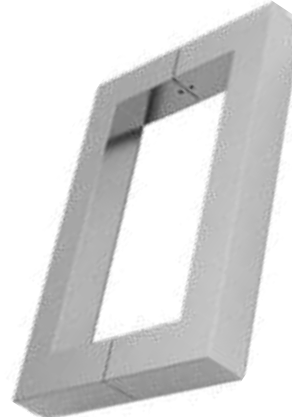

MAN-Q20
h 260 mm
MAN-Q30
h 300 mm

Maniglione quadro
Square handle



MAD-A30
Coppia maniglietta adesiva
b 15 mm x h 300 mm
Double adhesive handle

MAD-AQ30
Coppia maniglietta adesiva
b 90 mm x h 300 mm
Double adhesive handle



MAD-A15
Coppia maniglietta adesiva
b 15 mm x h 150 mm
spessore 5 mm
Double adhesive handle

MAD-AQ15
Coppia maniglietta adesiva
b 90 mm x h 150 mm
Double adhesive handle



AIP s.r.l. - Divisione VISIONI

Via Soleabò n. 20 - 12032 BARGE (CN) IT
Tel. +39 0175 343225 - Fax +39 0175 343503

E-mail: info@aipporte.com

www.visionicristaldesign.com

Certificazioni

AIP s.r.l. progetta e realizza tutti i suoi prodotti in osservanza al sistema di gestione della qualità secondo le normative prescritte dalla UNI EN ISO 9001:2015.

AIP s.r.l. designs and manufactures all of its products in accordance with the system of quality management according to the standards prescribed by the UNI EN ISO 9001:2015.



Tutti i modelli delle porte sono frutto della creatività del centro Design della AIP.

All models of the doors are the result of the creativity of the design center of the AIP.

Le finiture ed i colori illustrati nel presente catalogo sono da considerarsi puramente indicativi; inoltre AIP s.r.l. si riserva, anche senza preavviso, di apportare ai prodotti lievi modifiche e/o migliorie tecniche ed estetiche.

The finishes and colors shown in this catalog are purely indicative; also AIP s.r.l. reserves the right, without notice, to make minor changes to the products and / or technical and aesthetic improvements.

Stampa e produzione

L'ARTISTICA Savigliano
Via Palmiro Togliatti, 44, 12038 Savigliano (CN)

MARZO 2024



www.aipporte.com
info@aipporte.com

CRISTALDESIGN
VISIONI 

GRUPPO
AIP
PORTE NEL TEMPO 

AIP s.r.l. - Via Soleabò, 20 - 12032 San Martino Barge (Cn) - Italia - Tel. 0175.343225